



Video intercom IP System

CONFIGURATION MANUAL FOR THE INSTALLER

Table of Contents

1.	INTRODUCTION	5
2.	PASSWORD MANAGEMENT	5
3.	LIST OF DEVICES	6
4.	TECHNICAL CHARACTERISTICS OF DEVICES	7
4.1	OUTDOOR STATIONS	7
4.1.1	Access to name tags	8
4.1.2	Installation of outdoor stations	8
4.1.3	1-call outdoor station item VIIP-PE1	9
4.1.4	2-call outdoor station item VIIP-PE2	10
4.1.5	4-call outdoor station item VIIP-PE4	11
4.1.6	4-call (item VI-PEAUX4) and 8-call (item No. VI-PEAUX) auxiliary outdoor columns	12
4.1.7	Outdoor station model Building item VIIP-PE7T	13
4.2	INDOOR STATIONS	17
4.2.1	Intercom handset item VIIP-PICAB	18
4.2.2	Indoor station with 4.3" LCD touch item VIIP-PIT4B	21
4.2.3	Indoor station with 7" touch screen LCD item TS-SMART7xx	26
4.2.4	Indoor station with 10" touch screen LCD item TS-SMART10xx	27
4.2.4.1	Installation	29
4.2.4.2	Device size	30
4.2.4.3	Connecting the devices	31
4.2.4.4	Connecting the front door bell	31
4.2.4.5	Internal Parameters of TS-SMART7xx and TS-SMART10xx	32
	System Info	32
	Weather information	32
	System Apps	33
	Configuration menu	34
	Meaning of the configuration menu parameters	35
5.	MISCELLANEOUS ITEMS	43
5.1	IP Relay item VIIP-RELAY	43
5.2	48VDC PoE Switch item VIIP-SPOE	44
6.	INSTALLATION OF OUTDOOR STATIONS	46
6.1	Installation with outdoor station support plate	46
6.2	Installation with rain canopy	47
7.	CONFIGURATION OF MIFARE CARDS/TAGS	48
7.1	Card/tag programming	48
7.2	Creation of the MASTER card	48
7.3	Accessing the Card Registration Menu	49
7.4	Creating a USER card	50
7.5	Deleting a USER card	51
7.6	Creating a duplicate MASTER card	52

7.7	Cancelling all MASTER cards	53
7.8	Deleting all USER cards	54
8.	SYSTEM OPERATION	55
8.1	Calling from an outdoor station	55
8.2	Answering a call	56
	8.2.1 Meaning of the TS-SMARTxx buttons	56
	8.2.2 Intercom call between several flats with TS-SMARTxx	58
	8.2.3 Intercom call between several flats with VIIP-PIT4B	58
	8.2.3 Intercom call within the flat from TS-SMARTxx	59
	8.2.4 Calling the Concierge from TS-SMARTxx	59
8.3	Door opener function	61
	8.3.1 Item VIIP-PIT4B	61
	8.3.2 Item TS-SMARTxx	62
8.4	Door opener function with unlock code	63
8.5	Opening by means of a user card	63
8.6	AUTOMATIC DOOR OPENER FUNCTION (Doctor's Office Function)	63
8.7	Mute mode (Mute Function)	64
8.8	Configuration of external IP cameras	64
	8.8.1 View from TS-SMART7xx and TS-SMART10xx:	65
8.9	Replacing name tags	65
8.10	Restoring the default settings in outdoor stations	66
9.	SYSTEM ACTIVATION	67
9.1	Connecting devices	67
9.2	Interfacing with home automation and anti-intrusion alarm systems	67
9.3	"Main device" parameter	68
10.	CONFIGURING THE AVE VIDEO V44 APP	69
10.1	Preliminary steps for user registration	69
10.2	Associating devices with the App	71
10.3	Deleting Apps associated with the indoor station	72
10.4	Deleting devices in the App	72
10.5	Inviting new users to your system (system sharing)	73
10.6	Deleting an account	75
10.7	Answering a call	76
11.	V44 CONFIG CONFIGURATION SOFTWARE	78
11.1	Procedure for updating/changing the device parameters	78
	10.1.1 Updating the devices	78
	10.1.2 Changing the closing times of "Unlock 2" relay	80
	10.1.3 Changing the call and ringtone volume	80
	10.1.4 Creating a list of names	80
12.	WIRING DIAGRAMS	82
	12.1 Overview of the IP system	82

GENERAL WARNINGS

The Purchaser undertakes to handle the packaging with care and to store the material in an appropriate manner, in an environment without humidity and at a temperature not lower than -5 °C and not higher +40 °C.

The Purchaser undertakes to inform its own customers of the storage methods for the material supplied by AVE S.p.A.

The Purchaser undertakes to sell the Products in their original intact packaging. If this is not the case, the Purchaser undertakes to pass on to its customer the instructions for use supplied by AVE S.p.A. with the products. These instructions can also be found in catalogues, technical sheets, brochures, inserts and on the company' s website(www.ave.it).

In the case of the sale of AVE S.p.A. products in the countries of the European Union, the Purchaser undertakes to check that the instructions for use of the product in the AVE S.p.A. packaging contain the specific language of the country of destination. If this is not the case, the Purchaser undertakes to request AVE S.p.A. to include in the product instructions the language and/or symbols required for the export of the goods, or the Purchaser undertakes to do so on its behalf.

If the Purchaser opens the packaging before selling the products, the apparent integrity of the products must be verified; in case of doubt, the products must not be sold.

AVE S.p.A. products are products that require installation. Products and accessories must be installed by qualified personnel. The products must be installed and used in accordance with their intended purpose and in compliance with the standards applicable to the various types of installation, taking into account the provisions of the catalogue, the data sheets and the instructions published on the company's website. In any case, before putting the installed products into service, the system must be tested by authorised personnel to ensure its functionality and compliance with safety regulations in accordance with current legislation.

AVE S.p.A. reserves the right to modify and improve, without prior notice, the products illustrated in its catalogue and listed in the price list, due to the continuous process of productive, technological and regulatory adaptation. The product data sheet or other equivalent documentation is available on request from the AVE S.p.A. Technical Support Service. Consultation of the company's website for updates and confirmation of data is recommended (www.ave.it).

GENERAL INFORMATION

The AVE S.p.A. Video intercom system (Domina Video intercom range) has been designed, tested and approved in accordance with the European standards in force for the installation of electrical systems. For this reason, in addition to complying with the standards in force, it is essential to comply with all the system regulations, from the installation recommendations to the system configuration instructions described in the following paragraphs.

USEFUL REGULATORY REFERENCES

For the correct implementation of a networked hotel system, we recommend consulting some CEI standards such as:

- [CEI 64-8](#) Electrical system users with a nominal voltage not exceeding 1000 V alternating current and 1500 V direct current
- [CEI 64-55](#) Residential and commercial buildings - Guidelines for the integration of electrical system users and for the preparation of auxiliary, telephone and data transmission installations in buildings - Special criteria for hotels
- [CEI 64-100](#) Residential buildings- Guidelines for the preparation of electrical, electronic and communications infrastructures

INSTALLATION OF PRODUCTS

This device must be installed in accordance with its intended use and in compliance with all applicable codes, standards and installation regulations. The device must only be installed by qualified personnel. Improper installation or misuse of the device may result in risk of electric shock and/or fire and/or improper operation. Before installation, carefully read the relevant instructions (on the device and in the instruction manual, if available) and consult the technical information available at www.ave.it. If you believe that you do not have sufficient information for the installation, and/or if you need further clarification, please contact the AVE Technical Support Service on 0039 030 24981 and/or an AVE Customer Support Service (list available at www.ave.it). Observe the installation and connection procedures and the operating temperatures; before putting the installed products into service, have the system checked by qualified personnel. Do not open, dismantle or alter the product under penalty of forfeiture of warranty and exclusion of liability on the part of the company.

The AVE video-intercom system complies with the strictest product standards both as regards performance and safety requirements and compliance with the relevant environmental tests. It also contains advanced video surveillance functions (which can be activated during installation of the system) that may be subject to Regulation 679/2016 ("GDPR") and the General Provision of the Video surveillance authority of 8 April 2010. Since these indications establish specific obligations for the protection of privacy, we draw attention to the fact that the installation is carried out according to the current laws and legislative decrees on "privacy".

1. INTRODUCTION

The purpose of this manual is to guide the installer through the installation of a video intercom system and the subsequent configuration of the parameters necessary for its correct operation. In fact, the rest of this document will outline all the steps necessary for the optimum implementation of a system, starting with the brickwork and the implementation of the electrical system, and ending with an explanation of the meaning of all the icons in the various menus of the management software.

2. PASSWORD MANAGEMENT

To ensure the security of the system and your account, it is recommended that you change the default passwords used to access the system configuration menus.

3. LIST OF DEVICES

OUTDOOR STATIONS

1-call outdoor station
item **VIIP-PE1**

2-call outdoor station
item **VIIP-PE2**

4-call outdoor station
item **VIIP-PE4**

8-call auxiliary outdoor column
item **VI-PEAUX**

4-call auxiliary outdoor column
item **VI-PEAUX4**

Outdoor station model Building
item **VIIP-PE7T**

INDOOR STATIONS

Intercom handset
item **VIIP-PICAB**

Indoor station with 4.3" LCD
item **VIIP-PIT4B**

Indoor station with 7" LCD touch screen display
item **TS-SMART7ALS**
item **TS-SMART7ANS**

Indoor station with 10" LCD touch screen display
item **TS-SMART10ALS**
item **TS-SMART10ANS**

COMMON ITEMS

Relay module
item **VIIP-RELAY**

Switch with 8 x PoE 48VDC outputs
Item **VIIP-SPOE**

4. TECHNICAL CHARACTERISTICS OF DEVICES

4.1 OUTDOOR STATIONS

The functions and characteristics of this type of product are as follows:

CHARACTERISTICS	VIIP-PE1	VIIP-PE2	VIIP-PE4	VIIP-PE7T	VI-PEAUX	VI-PEAUX4
Maximum number of devices that can be installed on the system	32 in the "Villa" version and 16 per building in the "Building" version				4	4
Built-in installation	■	■	■	■	■	■
Wall-mounted installation	■	■	■	■	■	■
Aluminium front plate	■	■	■	■	■	■
Glass tag plate	■	■	■	X	■	■
Removable name tags	■	■	■	X	■	■
Name tag white light	■	■	■	X	■	■
On-board camera	■	■	X	■	X	X
Orientable camera	■	■	X	■	X	X
Camera resolution	2 M pixels				X	X
LED for camera night lighting	■	■	X	■	X	X
Twilight sensor	■	■	X	■	X	X
Number of calls on board	1	2	8	1000	8	4
On-board relay with power output	■	■	X	■	X	X
On-board relay with normally open contact	■	■	X	■	X	X
Removable terminal block	■	■	■	■	■	■
Automatic door opening (Doctor's office function)	■	■	■	■	■	■
Pulse control release button input	■	■	X	■	X	X
Open gate status detection	■	■	X	■	X	X
Adjustable electro-lock unlock time	■	■	X	■	X	X
MIFARE® card reader	■	■	X	■	X	X
Line busy signal	■	■	■	■	■	■
Call forwarded tone	■	■	■	■	■	■
In-wall installation with box	VI-BOX3N			VI-BOX5	VI-BOX3N	VI-BOX3N
Compatible support frame	VI-BOX3C			VI-BOX5C	VI-BOX3C	VI-BOX3C
Wall installation with box	VI-BOX4			VI-BOX6	VI-BOX4	VI-BOX4
Rain canopy, item	VI-RPBOX3			VI-RPBOX5	VI-RPBOX3	VI-RPBOX3
Multiple installation with VI-PEAUX	■	■	■	■	■	■
Multiple installation with VI-PEAUX4	■	■	■	■	■	■

4.1.1 Access to name tags

The VIIP-PE1, VIIP-PE2, VIIP-PE4, VI-PEAUX devices have name tags on which it is possible to write the name of the user who will answer a call forwarded by pressing the button next to them.

In order to access the name plates, remove the front plate by unscrewing the screw at the bottom of the device, lifting the glass frame and pulling the lower part towards you.

To reinstall the front plate, just follow the instructions in reverse order.

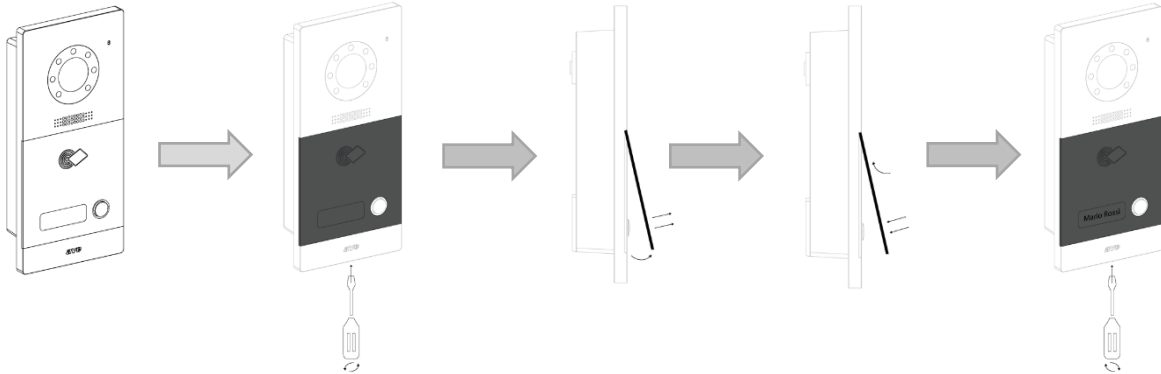

4.1.2 Installation of outdoor stations

When installing the outdoor station, position the devices at a height of approximately 160 cm (top profile).

For use by disabled persons, the recommended height is approx. 140 cm (top profile), unless otherwise stipulated by current legislation.

Outdoor stations should be installed so that the camera is not exposed to direct light sources (street lamps, floodlights or direct sunlight) that would affect its operation.

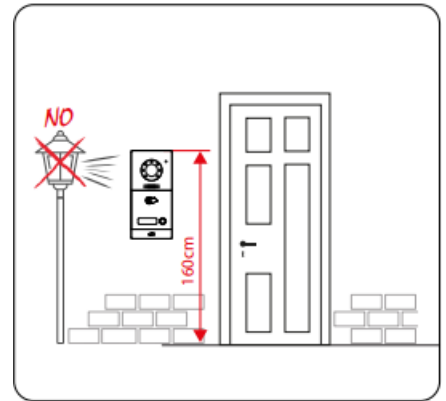

After mounting the box in the wall, install the support frame using the 4 screws supplied with the indoor station. Mount the outdoor station by first anchoring it to the lugs at the top and then slide the indoor station into the box.

Secure the product to the box using the 2 screws supplied with the indoor station.

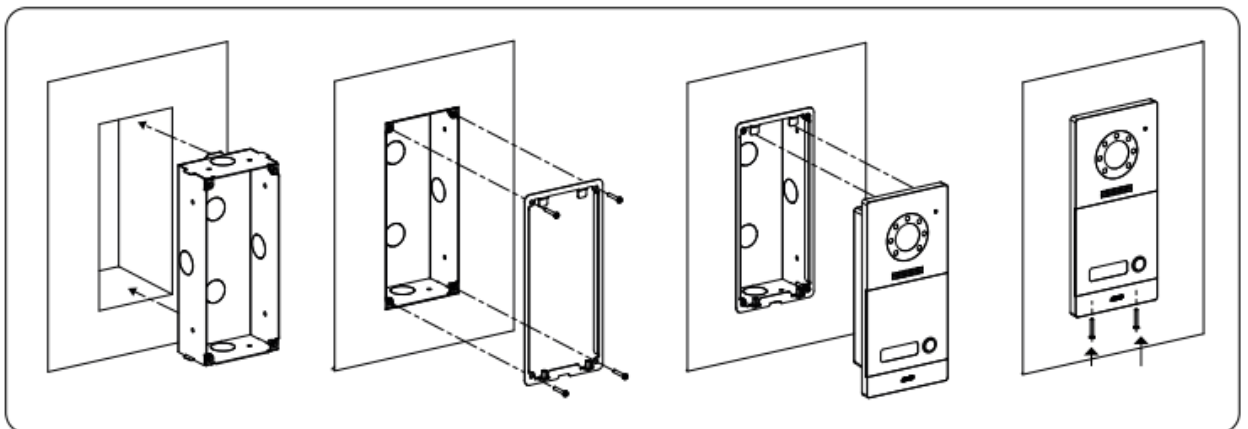

4.1.3 1-call outdoor station item VIIP-PE1

The VIIP-PE1 device is the audio/video outdoor station of the AVE V44 SMART IP video intercom system.

The technical specifications of the 1-call outdoor station are given below:

CHARACTERISTICS

Height (mm)	215
Product width (mm)	100
Product depth (mm)	45.7
Camera	2 M pixels
MIFARE reader	Integrated for ISO7816 format cards

CLIMATIC OPERATING CONDITIONS

Temperature	-25 °C – +55 °C
Maximum relative humidity	90% at 35°C
Maximum altitude	2000 m a.s.l.
Protection rating	IP20 (IP44 when installed)
Weight	604 g

USE DATA

Maximum operating voltage	24VDC with 48VDC auxiliary power supply via PoE switch
Absorption during operation	250 mA max @24 Vdc
Absorption during stand-by	70 mA max @24 Vdc
Absorption during operation	100 mA max @48 Vdc PoE
Absorption during stand-by	50 mA max @48 Vdc PoE

CONNECTIONS 1 (RJ45)

LAN cable connection PoE 48VDC

CONNECTIONS 2 (INPUTS/OUTPUTS)

Terminal #1	DOOR N.O. button input for door opening
Terminal #2	GS door open sensor input
Terminal #3	N.O. normally open contact for door opening
Terminal #4	N.O. normally open contact for door opening
Terminal #5	EL "high energy" output for door opening
Terminal #6	GND shared by GS and DOOR inputs and EL output

CONNECTIONS 3 (AUXILIARY COLUMN EXTENSION)

Connector for connecting auxiliary columns

CONNECTIONS 4 (POWER SUPPLY)

Terminal #1	+24Vdc
Terminal #2	GND

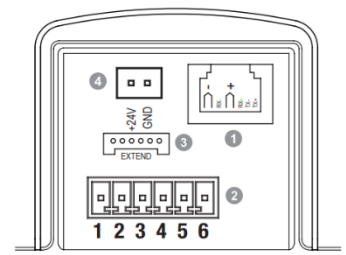
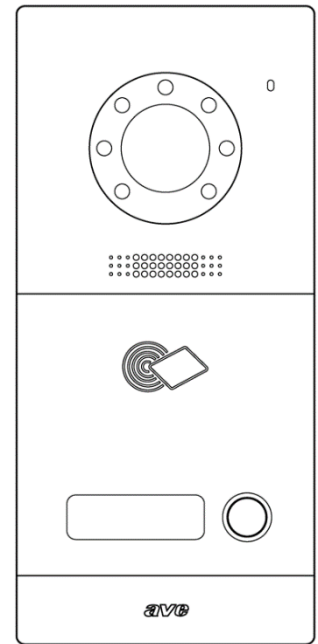

4.1.4 2-call outdoor station item VIIP-PE2

The VIIP-PE2 device is the audio/video outdoor station of the AVE V44 SMART IP video intercom system.

The technical specifications of the 2-call outdoor station are given here below:

CHARACTERISTICS

Height (mm)	215
Product width (mm)	100
Product depth (mm)	45.7
Camera	2 M pixels
MIFARE reader	Integrated for ISO7816 format cards

CLIMATIC OPERATING CONDITIONS

Temperature	-25 °C – +55 °C
Maximum relative humidity	90% at 35°C
Maximum altitude	2000 m a.s.l.
Protection rating	IP20 (IP44 when installed)
Weight	604 g

USE DATA

Maximum operating voltage	24VDC with 48VDC auxiliary power supply via PoE switch
Absorption during operation	250 mA max @24 Vdc
Absorption during stand-by	70 mA max @24 Vdc
Absorption during operation	100 mA max @48 Vdc PoE
Absorption during stand-by	50 mA max @48 Vdc PoE

CONNECTIONS 1 (RJ45)

LAN cable connection PoE 48VDC

CONNECTIONS 2 (INPUTS/OUTPUTS)

Terminal #1	DOOR N.O. button input for door opening
Terminal #2	GS door open sensor input
Terminal #3	N.O. normally open contact for door opening
Terminal #4	N.O. normally open contact for door opening
Terminal #5	EL "high energy" output for door opening
Terminal #6	GND shared by GS and DOOR inputs and EL output

CONNECTIONS 3 (AUXILIARY COLUMN EXTENSION)

Connector for connecting auxiliary columns

CONNECTIONS 4 (POWER SUPPLY)

Terminal #1	+24Vdc
Terminal #2	GND

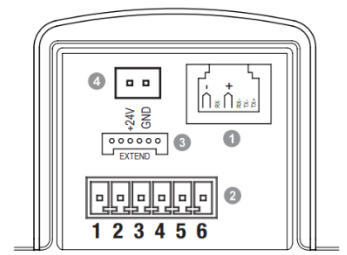
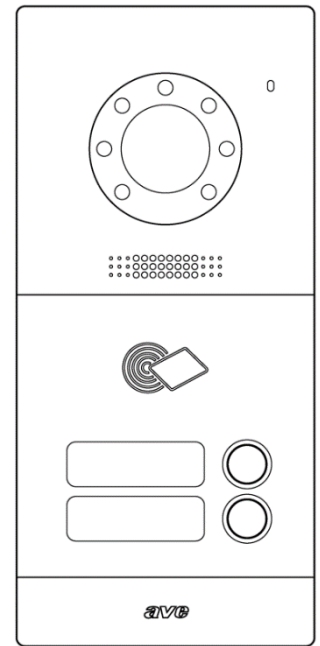

4.1.5 4-call outdoor station item VIIP-PE4

The VIIP-PE4 device is the audio/video outdoor station of the AVE V44 SMART IP video intercom system.

The technical specifications of the 4-call outdoor station are given here below:

CHARACTERISTICS	
Height (mm)	215
Product width (mm)	100
Product depth (mm)	45.7
Camera	2 M pixels
MIFARE reader	Integrated for ISO7816 format cards

CLIMATIC OPERATING CONDITIONS	
Temperature	-25 °C – +55 °C
Maximum relative humidity	90% at 35°C
Maximum altitude	2000 m a.s.l.
Protection rating	IP20 (IP44 when installed)
Weight	604 g

USE DATA	
Maximum operating voltage	24VDC with 48VDC auxiliary power supply via PoE switch
Absorption during operation	250 mA max @24 Vdc
Absorption during stand-by	70 mA max @24 Vdc
Absorption during operation	100 mA max @48 Vdc PoE
Absorption during stand-by	50 mA max @48 Vdc PoE

CONNECTIONS 1 (RJ45)	
LAN cable connection PoE 48VDC	

CONNECTIONS 2 (INPUTS/OUTPUTS)	
Terminal #1	DOOR N.O. button input for door opening
Terminal #2	GS door open sensor input
Terminal #3	N.O. normally open contact for door opening
Terminal #4	N.O. normally open contact for door opening
Terminal #5	EL "high energy" output for door opening
Terminal #6	GND shared by GS and DOOR inputs and EL output

CONNECTIONS 3 (AUXILIARY COLUMN EXTENSION)	
Connector for connecting auxiliary columns	

CONNECTIONS 4 (POWER SUPPLY)	
Terminal #1	+24Vdc
Terminal #2	GND

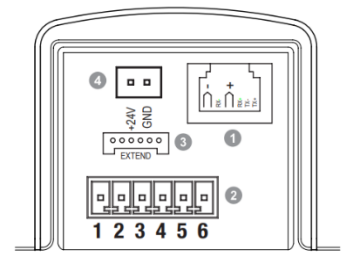
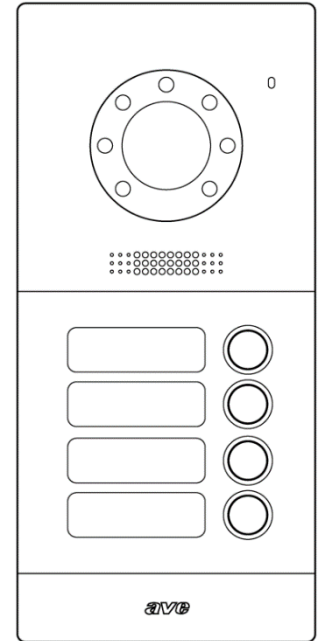

4.1.6 4-call (item VI-PEAUX4) and 8-call (item No. VI-PEAUX) auxiliary outdoor columns

The VI-PEAUX4 and VI-PEAUX devices allow expanding the number of outdoor station call buttons by an additional 4 (item VI-PEAUX4) and 8 (item VI-PEAUX). The devices are common to the Domina 2-wire AVE V44 SMART and IP AVE V44 SMART ranges.

Possibility of adding up to 4 devices to increase the number of external calls to a maximum of 36.

The technical specifications of the auxiliary outdoor station are given here below:

CHARACTERISTICS	
Height (mm)	215
Product width (mm)	100
Product depth (mm)	45.7
CLIMATIC OPERATING CONDITIONS	
Temperature	-25 °C – +55 °C
Maximum relative humidity	90% at 35°C
Maximum altitude	2000 m a.s.l.
Protection rating	IP20 (IP40 when installed)
Weight	604 g
OPERATING VOLTAGE	
Rated voltage	5Vcc from flat connector
Absorption in operation	20 mA max @ 5 VDC
CONNECTIONS	
Extend Connector 1	Connection to previous outdoor station
Extend Connector 2	Connection to the next outdoor station

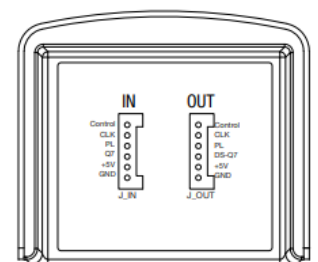
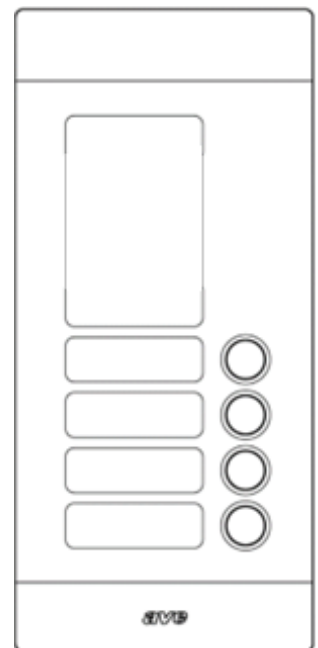
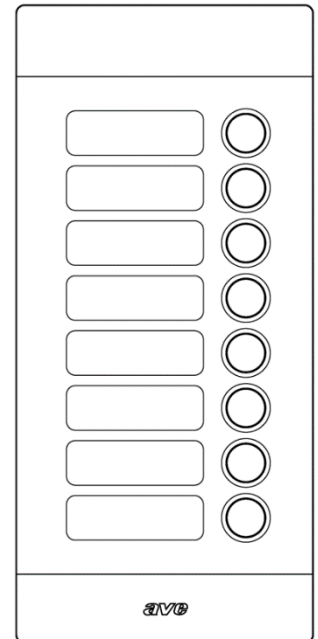

4.1.7 Outdoor station model Building item VIIP-PE7T

The VIIP-PE7T device is the audio/video outdoor station of the AVE V44 SMART IP video intercom system equipped with a 7" Touch Screen LCD monitor.

The technical specifications of the outdoor station with 7" LCD are given here below:

CHARACTERISTICS	
Height (mm)	369
Product width (mm)	148.5
Product depth (mm)	49
Camera	2 M pixels
MIFARE reader	Integrated for ISO7816 format cards
CLIMATIC OPERATING CONDITIONS	
Temperature	-25 °C – +55 °C
Maximum relative humidity	90% at 35°C
Maximum altitude	2000 m a.s.l.
Protection rating	IP20 (IP44 when installed)
Weight	1480 g
USE DATA	
Maximum operating voltage	24VDC with 48VDC auxiliary power supply via PoE switch
Absorption during operation	400 mA max @24 Vdc
Absorption during stand-by	300 mA max @24 Vdc
Absorption during operation	220 mA max @48 Vdc PoE
Absorption during stand-by	120 mA max @48 Vdc PoE
AUX POWER SUPPLY 1	
Terminal #1	+24Vdc
Terminal #2	GND
CONNECTIONS 2 (INPUTS/OUTPUTS)	
Terminal #1 (+V)	+VDC output for EL, to be connected to COM (unlock 1)
Terminal #2 (COM)	Common contact for EL door unlock
Terminal #3 (EL)	Door unlock output (12V 13W max)
Terminal #4 (-)	Not in use
Terminal #5 (GND)	EL door unlock reference
Terminal #6 (GS)	Door open sensor input
Terminal #7 (DOOR)	Door unlock NO button input
Terminal #8 (GND)	Ref. for door sensor and door opening button
CONNECTIONS 3 (INPUTS/OUTPUTS)	
Terminal #1 (NO)	NO contact for gate opening (unlock 2)
Terminal #2 (COM)	Common NO contact for gate opening
Terminal #3 (GATE)	Gate opening NO button input
Terminal #4 (GND)	Reference for GATE inputs and RS485 interface
Terminal #5 (DA)	Not in use - RS485 DA interface
Terminal #6 (DB)	Not in use - RS485 DB interface
CONNECTIONS 4 (RJ45)	
LAN cable connection PoE 48VDC	

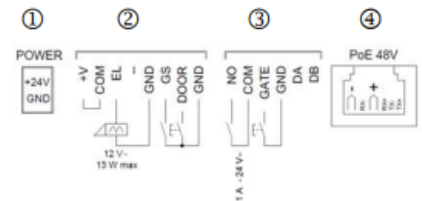
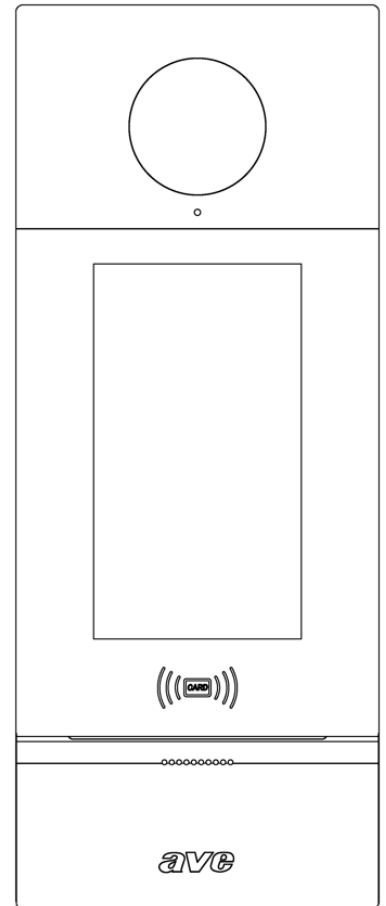

1) INSTALLATION

The outdoor station can be installed on VI-BOX5 (in-wall) or VI-BOX6 (wall-mounted) boxes. The suggested installation height of the product is at 1.5 m from the ground.

Power the device directly from the RJ45 cable by connecting a 48VDC PoE switch (item VIIP-SPOE) or from a 24VDC switching power supply by connecting it to the "Power" connector using the supplied cable.

2) ACCESS TO CONFIGURATION PARAMETERS

To access the advanced parameters of the device:

1. press 5 times on the AVE tab at the top of the LCD;
2. enter flat number 0000;
3. enter the default password 222222

3) MEANING OF THE PARAMETERS

System Settings Menu

Volume

Waiting sound: adjustment of the sound emitted by the outdoor station while waiting for the call to be answered (Zero= no sound; Three= maximum volume);

Volume of the call: volume of the loudspeaker during a call (One= minimum volume; Three= maximum volume);

Door alarm status: sound emitted when the door is left opened. The sound emission is linked to the installation of a sensor between the open door input and GND;

Lock unlocking message: door open sound emission when the door is unlocked;

Other indications: sound emitted when a button on the device's touch screen is pressed;

Sound enhancement: function not currently managed.

Language: language used on the device;

Unlock settings:

Facial recognition: activation of the device's facial recognition feature;

Common password activation: activation of the common password for all tenants of the system;

User PIN activation: activation of the flat-specific password. The function is only available if a TS-SMARTxx is fitted in the flat. The user PIN corresponds to the user password entered in the TS-SMARTxx.

Common password change: menu for changing the system's common password

Twilight sensor threshold: adjustment of the threshold of the twilight sensor used for facial recognition.

Display configuration:

Brightness: menu for configuring the display brightness of the device (1 minimum value; 5 maximum value);

Activate screensaver: activate and set the device's screensaver activation time;

LCD off after (Min): time in minutes between when the screensaver is activated and when the device's LCD is turned off.

Card management:

User card

User card registration: touch the reader with a card (item 44339CHU-MB or 44339CHU-MT) to associate it with the system;

Check card information: touch the reader with a card (item 44339CHU-MB or 44339CHU-MT) to read the data stored on it;

Delete user card: touch the reader with a card (item 44339CHU-MB or 44339CHU-MT) or enter the serial number of a card to delete it from the list of cards stored in the device;

Delete all user cards: if this parameter is selected, all cards associated with the system will be deleted and no longer available. Deleted cards may be reused.

Security card

Insert security card: touch the reader with a card (item 44339CHU-MB or 44339CHU-MT) to associate it with the system using the "Security" function;

Unlock settings: activation of power unlocking via the security card;

Check card information: touch the reader with a card (item 44339CHU-MB or 44339CHU-MT) to read the data stored on it;

Delete security card: touch the reader with a security card (item 44339CHU-MB or 44339CHU-MT) or enter the serial number of a card to delete it from the list of cards stored in the device;

Delete all security cards: if this parameter is selected, all cards associated with the system will be deleted and no longer available. Deleted cards may be reused.

Copy registered cards: the function allows the association of cards registered in the device with other outdoor stations (VIIP-PE7T) installed in the system.

Allow copying of cards: this function enables the copying of registered cards (see the previous parameter).

Face registration: menu to associate a flat with a face. Face recognition activates the power relay unlock.

Name list: menu for entering the name list associated with the flats in the system. Access to this menu is only possible if the corresponding parameter has previously been activated in the "Configuration" menu. Press the "+" button to enter new names. The order in which the names are entered in the list is the order in which they are displayed on the home page of the device.

Unlock time: closing time (in seconds) of the dry contact unlock.

Configuration Menu

System Properties

No. of digits in the call: enter 3 or 4 digits when dialling the number to be called (e.g. 001 or 0001);

Door alarm status: activation of the "door open" input supervision function;

Analogue video intercom switch: reserved parameter not to be changed;

Type of installation: selection of device type.

Building: management of up to 32 devices

Villa: management of up to 16 devices

Facial recognition

Motion detection: activation of the motion sensor, which automatically activates the LCD screen;

No. of faces per flat: number of faces that can be associated with each flat;

Threshold settings: motion sensor sensitivity setting.

Proximity sensor: activation of the proximity sensor that automatically activates the facial recognition function.

Relay configuration: menu for associating an auxiliary relay (item VIIP-RELAY) with the device. A maximum number of two relay devices (each with two independent N.C. or N.O. relay contacts on board) can be associated with the external VIIP-PE7T station. The programming of the relay's IP address and ID must be carried out using the AVE V44 CONFIG programming software. Exiting the menu is equivalent to saving the data entered.

Password configuration: menu for entering the administrator password for the device. This password is used to access the configuration parameters of the device.

Name list activation

Name list: activation of the display of the list of system extensions;

Display modes

List with icons: display of the "Avatar" icon next to the entered alphanumeric string;

List without icons: display of only the alphanumeric string entered;

Rows displayed per page: number of names displayed on the home page. It is recommended to use the value 6 if the page scrolling name list is selected.

Alignment: alignment of the name list to the top or bottom of the device's LCD screen if the entered name list does not contain the minimum number of 6 records;

Page change mode: parameter used to select the display of the name list in scrolling or page change mode. The function is activated when the number of flats in the name list exceeds six.

Concierge activation: if there is a manned concierge station on the system, in which the concierge station (item VIIP-GUARD) has been installed, activating this parameter will display a button on the LCD of the outdoor station to call it directly.

Information

Version: display of the software version installed on the device;

System Test: device functionality test page;

Log: reserved parameter;

Reboot: device reboot;

Factory reset: button for resetting the device to default settings. Restoring the default settings intentionally does not delete the card list and captured face images. For a complete reset to default settings, perform an initial reset and then perform another reset within one minute of power-up.

Call activation: if deactivated, the outdoor station cannot make calls to the system's indoor stations.

4.2 INDOOR STATIONS

CHARACTERISTICS	VIIP-PICAB	VIIP-PIT4B	TS-SMART7..	TS-SMART10..	TS-SMART18..
LCD size	X	4.3"	7"	10"	18"
LCD Touch Screen	X	X	■	■	■
Max. number of indoor stations per flat	4				
Power supply from 24VDC switching power supply unit	■	■	■	■	■
Power supply from 48 VDC PoE Switch	■	■	■	■	■
Answering calls from outdoor stations	■	■	■	■	■
Intercom calls	X	■	■	■	■
Intercom call	X	■	■	■	■
Connection to the home Wi-Fi network	X	X	■	■	■
Interfacing with residential home automation	X	X	■	■	■
Interfacing with anti-intrusion alarm control units of the AF927 range	X	X	■	■	■
Interfacing with KNX bus	X	X	X	■	■
Opening external gates	■	■	■	■	■
Maximum number of external gates that can be managed	3	3	6	6	6
Door bell button input	■	■	■	■	■
Auxiliary relay activation	X	■	■	■	■
"Mute" function	■	■	■	■	■
View of outdoor station camera	X	■	■	■	■
View of auxiliary cameras	X	■	■	■	■
Multi-language management	X	■	■	■	■
Activation of "Doctor' s Office" mode	X	X	■	■	■
"Gate Open" signal	X	■	■	■	■
Frame capture when receiving a call	X	X	■	■	■
Video recording during the call	X	X	■	■	■
Ambient light LED bar	X	X	X	■	■
Installation on box 2501, horizontal centre distance 60 mm	■	X	X	X	X
Installation on 2502 box	■	X	X	X	X
Wall-mounting on 2503 horizontal box	X	X	■	X	X
In-wall mounting on 2503 horizontal housing	X	X	X	■	X
Wall-mounting on 2503 vertical box	X	■	X	X	X
In-wall mounting on BL07 horizontal housing	X	X	X	X	■

4.2.1 Intercom handset item VIIP-PICAB

The VIIP-PICAB device is an audio indoor station of the AVE V44 SMART IP video intercom system.

The device can be powered by a 24VDC switching power supply (via the supplied cable) or directly by data cable via a 48 VDC PoE Switch.

The technical specifications of the intercom handset are given here below:

CHARACTERISTICS	
Height (mm)	210
Product width (mm)	78
Product depth (mm)	52.8
Maximum number of devices that can be installed	Max 4 devices for each apartment
CLIMATIC OPERATING CONDITIONS	
Temperature	-25 °C – +55 °C
Maximum relative humidity	90% at 35°C
Maximum altitude	2000 m a.s.l.
Protection rating	IP20 (IP40 when installed)
Environmental class	Class III
Weight	246 g
OPERATING VOLTAGE	
Maximum operating voltage	24Vdc with aux power supply 48VDC via PoE switch
Absorption during operation	70 mA max @ 24 VDC
Absorption during stand-by	35 mA max @ 24 VDC
Absorption during operation	40 mA max @48 VDC PoE
Absorption during stand-by	25 mA max @48 VDC PoE
CONNECTIONS: 24VDC power supply	
GND terminal	GND 24 VDC power supply
+24V terminal	+ 24 VDC power supply
GND terminal	reference for door bell input
"Door bell" terminal	Door bell input
IP grid interface	
Shielded RJ45 connector	48V _{DC} standard PoE
DEVICES THAT CAN BE INSTALLED	
Maximum number	Up to 4 devices (total sum of devices, also different) per flat

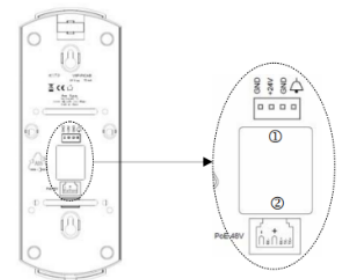
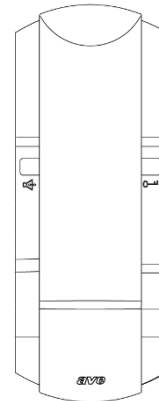

4) INSTALLATION, POSITIONING AND FIXING

The handset must be installed indoors, within the temperature limits indicated, and following the instructions in this document. The device can be installed on round boxes 2501, or square boxes 2502. The suggested installation height of the product is at 1.5 m from the ground. Refer to Figures 1 and 2 to install the devices.

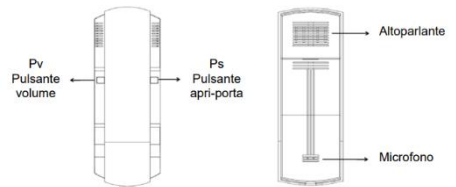

5) DEVICE ADDRESS CONFIGURATION

Apartment No.

Open the Ave Configuration Tool software and press the "search" button; then select the device that has to be configured among those proposed by the software.

Press "Connect" to begin the configuration; In the same interface, enter the room number in the "Device ID" option (Format of the "Device ID": BBB-AAAA-D)

Explanation:

- BBB Building (001 ÷ 999 or 000 for "Villa" configuration)
- AAAA Flat (0001 ÷ 1900)
- D Device (1 to 4)

6) RINGTONE VOLUME AND TONE

When the device is ringing, press and release the volume button to adjust the volume of the ringtone. The default volume is level 3; with each short press the volume will increase by one level. Once the maximum level of 5 is reached, level 1 will be proposed again. The last selected level will be stored.

7) AUDIO VOLUME

When the conversation has started, press and release the volume button to adjust the volume of the conversation. The default volume is level 3; with each short press the volume will increase by one level. Once the maximum level of 5 is reached, level 1 will be proposed again. The last selected level will be stored.

8) RESETTING TO FACTORY SETTINGS

Within 60 s of switching on the device, press and hold the volume button for 3 s - you will enter the restore default settings mode with the emission of a long beep; press and release the volume button again to confirm the resetting to default settings (another long beep will be emitted).

Note: after restoring the default settings, the device assumes default settings that may conflict with other installed devices. In this case, the device will emit a fault alarm (check if there is a conflict between the room number or the MAC address). In this case, change the room number of the device; when the configuration is complete, the fault alarm will stop.

9) BASIC FUNCTIONS

The basic functions of the device are illustrated here below:

a) ANSWERING AN INCOMING CALL

In stand-by mode, when the device starts ringing, lift the handset to answer an incoming call.

b) ENDING A CALL

During the 120 s (maximum call time) of conversation, it is possible to end the call by hanging up the handset.

c) DOOR OPENING

When the device is in stand-by mode, is receiving a call, or during a conversation with an outdoor station, briefly press the door-opening button "Ps" to open door No. 1 (EL high energy output on the outdoor stations). Pressing and holding (3 s) the same button effects the second output of the outdoor stations (NO contact). If the relay module (VIIP-RELAY) is present, press and hold (3 s) the "PV" volume button to effect the corresponding output.

d) CALLING THE CONCIERGE

In stand-by mode, lift the handset, then press and hold (3 s) the door opening button "Ps" to call the concierge. If the device emits 3 short "beeps", the call was unsuccessful.

e) INCOMING CALL FROM DOOR BELL BUTTON

The device will emit a sound when the door bell button connected to its input is pressed (sound independent of the main ringtone).

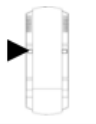
RIASSUNTO FUNZIONI PULSANTI						
Pulsante	Durata	Entro 60 s dal power-on	Standby	Standby cornetta sganciata	Chiamata in corso	Conversazione in corso
Pv 	Breve	Regol. volume suoneria			Regol. volume suoneria	Regol. volume audio
	Lunga	Reset	Uscita 3 (relè ausil.)		Uscita 3 (relè ausil.)	Uscita 3 (relè ausil.)
Ps 	Breve	Selez. tono suoneria	Uscita 1 (EL)		Uscita 1 (EL)	Uscita 1 (EL)
	Lunga		Uscita 2 (contatto NA)	Chiamata portiere	Uscita 2 (contatto NA)	Uscita 2 (contatto NA)

4.2.2 Indoor station with 4.3" LCD touch item VIIP-PIT4B

The VIIP-PIT4B device is an audio indoor station of the AVE V44 SMART IP video intercom system.

The device can be powered by a 24VDC switching power supply (via the supplied cable) or directly by data cable via a 48 VDC PoE Switch.

Video intercom between resident unit and outdoor or concierge unit - Front door bell function - Intercommunication between units within the same flat or between different flats - Provision for controlling up to 3 locks.

The technical specifications of the device are given here below:

CHARACTERISTICS	
Height (mm)	180
Product width (mm)	123
Product depth (mm)	20.5
LCD	4.3"
CLIMATIC OPERATING CONDITIONS	
Temperature	-25 °C – +55 °C
Maximum relative humidity	90% at 35°C
Maximum altitude	2000 m a.s.l.
Protection rating	IP20 (IP40 when installed)
Weight	290 g
VOLTAGE/ABSORPTION	
Maximum operating voltage	24 VDC with auxiliary power supply 48 VDC via PoE switch
Absorption during operation	100 mA @24 VDC
Absorption during stand-by	60 mA @24 VDC
Absorption during operation	60 mA @48 VDC PoE
Absorption during stand-by	40 mA @48 VDC PoE
DISPLAY	
Format	4.3" - Resolution 480 X 272 pixels
DEVICES THAT CAN BE INSTALLED	
Maximum number	Up to 4 devices (total sum of devices, also different) per flat

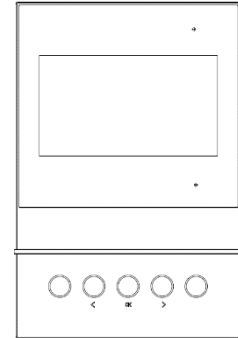

1) INSTALLATION

The device should be installed at a height of 1.5 m from the ground.

The VIIP-PIT4B is a wall-mounted device with a mounting plate on a vertically recessed 3-module box. To install the device, screw in the supplied screws to secure the support bracket to the box. Once wiring operations have been completed, align the slots in the back of the monitor with the bracket hooks and slide the device slightly downwards.

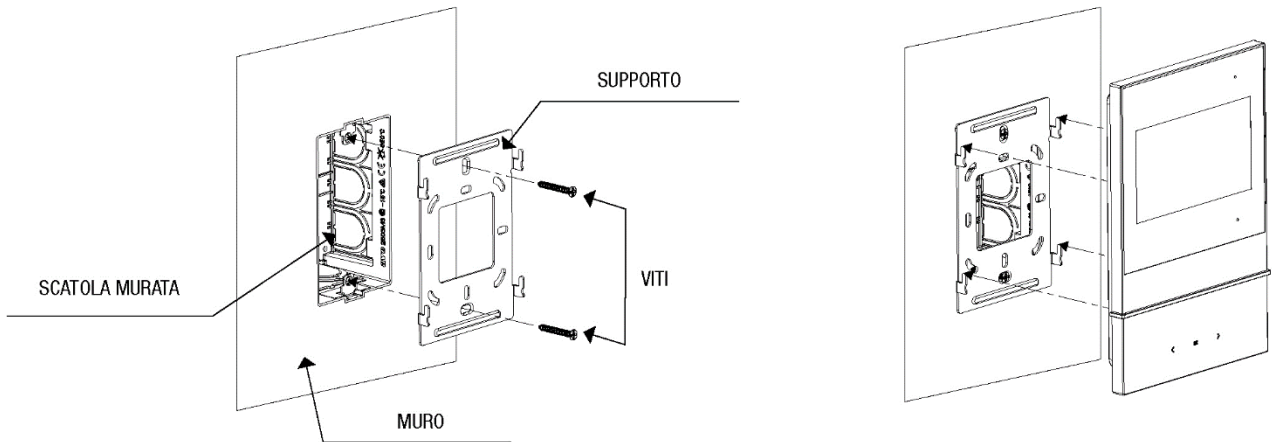

2) DEVICE SIZE

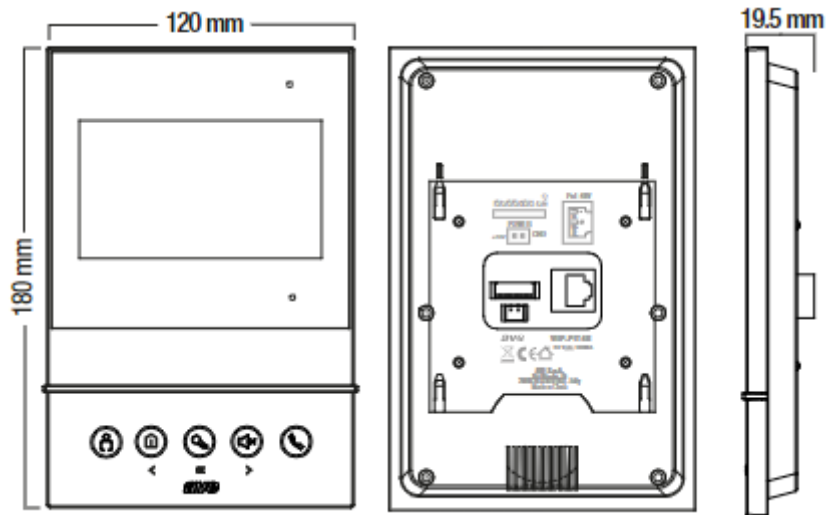

3) DEVICE

CONNECTION

The VIIP-PIT4B touch screen monitor (indoor station) can be powered in two ways:

- Via standard 48VDC PoE switch
- Via a stabilised 24V_{DC} power supply using the special cable supplied with the device by connecting it to connector J4 (check the correct polarity before connecting the connector).

It is not possible to use both power modes simultaneously as this may cause irreparable damage to the device.

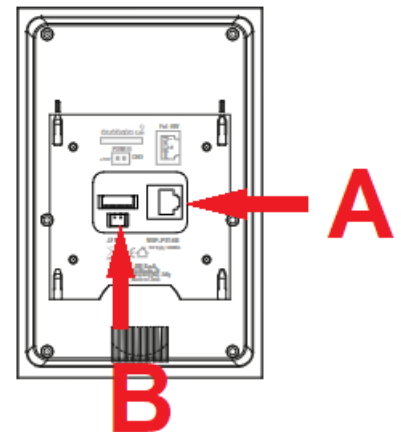



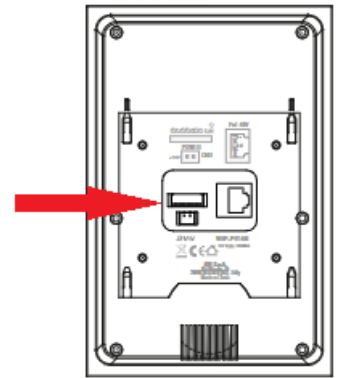

4) CONNECTING THE FRONT DOOR BELL

The devices are supplied with a connector to connect the front door bell. Connect a button with a normally open contact (e.g. item 441001) to the GND (black wire) and Z8 (blue wire) terminals of the pre-wired connector supplied with the device. Pressing the button will cause the touch screen to emit an audible signal.







5) MEANING OF THE DEVICE TOUCH BUTTONS

The meaning of the touch buttons located on the lower section of the device is given below:

					
LCD OFF	Activation of the audio/video communication with the outdoor unit camera (building/villa). When communication has been established, press the button to display the camera of the next outdoor station	Calling the concierge (if present)	LCD switch-on	Muting/un-muting the ringtone. Press and hold to mute/un-mute the ring tone on all indoor units in the flat.	LCD switch-on
LCD ON	Activation of the audio/video communication with the outdoor unit camera (building/villa). When communication has been established, press the button to display the camera of the next outdoor station	Left swipe button	OK button (e.g. confirmation of access to a menu) During a call, it allows: Short press: opening gate 1 Press >3 sec: opening gate 2	Right swipe button	Answering or ending a call













6) HOME PAGE

The device is equipped with a colour LCD screen which displays the date and time as well as the five buttons for accessing the various menus.

To access the menus, select the appropriate icon and press the "OK" button. To move within the graphical interface, press the  and  buttons; to confirm your choice,   button. The meaning of the menus is  llustrated below:

N.B.

Within all menus, press the  button to save the  ration performed and press the  button to cancel the  ration.

- **CALLS:** access to the menu allows:
 - a) calling the concierge (if present);
 - b) displaying the camera of outdoor stations;
 - c) making an intercom call within the same flat: select the "Intercom" button to:
 - initiate a call to all indoor stations in a flat. All indoor stations will automatically activate the communication to the calling indoor station;
 - initiate a call to an individual indoor station in the flat. The called indoor station starts ringing while waiting for the user to answer.
 - d) intercom call to different flats. Enter the number of the building and flat to be called and press the  button.
- **CALL LOG:** display of calls made to/received from the indoor station. Press the  button for two seconds to clear the call  g. Confirm or cancel the operation by pressing the appropriate buttons shown on the LCD of the device.
- **INFORMATION LOG:** display of any messages sent from the "Concierge" station (if present).
- **SETTINGS:** access to the device settings menu:
 - a) **Languages:** Selection of the language used by the device. Select the desired language and confirm or cancel the operation using the appropriate buttons shown on the LCD of the device;
 - b) **Time:** select the parameter to be changed using the   and press the  button to  e it editable. Press the   buttons to increase   decrease the value of the parameter. Press the  button to confirm the change.
 - c) **Configure:** enter the access password 222222 and confirm the operation by pressing the appropriate button.

Flat number: when programming the system, access the menu to enter:
the building: this is the identification number of the building.
the flat: identifies the progressive number of the flat within a building;
the number: is the progressive number of the indoor station in the flat (e.g. if there is only one indoor station in the apartment, the number to be assigned is 1; if there are two, the first indoor station has address 1 and the second indoor station has address 2);
Reset: resetting the device to default settings. Confirm or reject the operation using the appropriate buttons.
Back: back to previous menu
- **DND:** press the  button to activate/deactivate the "Do Not Disturb" function. When the button is pressed and held, the "Do Not Disturb" function is propagated to all the indoor stations in the flat. The active DND mode is displayed via a special symbol on the home page.
- **Information:** display of firmware versions installed in the device software versions;
- **Back:** back to previous menu

7) DEVICE CONFIGURATION MENU

Power the device via the PoE 48V_{DC} switch or via the 24V_{DC} switching power supply.

In order for the device to work properly, it is necessary to assign a unique address within the video intercom system.

To do this, access the menu:

SETTINGS/Configure: enter the access password 222222 and confirm the operation by pressing the button displayed on the LCD.

Then access the menu:

Flat number: enter:

the building: this is the identification number of the building. In a single home, the number will correspond to 1, in a building complex (e.g. block of flats) it identifies the progressive number of the building. Select the parameter to be edited with the buttons and press the button to make it editable. Press the buttons to increase or decrease the value of the parameter. Press the button to confirm the change.

the flat: identifies the progressive number of the flat within a building. Select the parameter to be edited with the buttons and press the button to make it editable.

Press the button to increase or decrease the value of the parameter. Press the button to confirm the change.

the number: is the progressive number of the indoor station in the flat (e.g. if there is only one indoor station in the apartment, the number to be assigned is 1; if there are two, the first indoor station has address 1 and the second indoor station has address 2);

Press the button to increase or decrease the value of the parameter. Press the button to confirm the change.

Press the button to confirm the address entered or press the button to cancel the operation.

4.2.3 Indoor station with 7" touch screen LCD item TS-SMART7xx

The TS-SMART7ALS and TS-SMART7ANS devices are audio indoor stations of the AVE V44 SMART IP video intercom system.

The device can be powered by a 24VDC switching power supply (via the supplied cable) or directly by data cable via a 48 VDC PoE Switch.

The technical specifications of the indoor station with 7" Touch Screen LCD are given here below:

CHARACTERISTICS	
Height (mm)	140
Product width (mm)	220
Product depth (mm)	27
Display format	7" touch screen display - 1024 x 600 pixels
Video intercom connections	RJ45 connector
Connections to the following systems Smart home and Anti-intrusion	Via integrated Wi-Fi network. Wired connection on the RJ45 connector is possible if there is no video intercom system
CLIMATIC OPERATING CONDITIONS	
Temperature	-25 °C – +55 °C
Maximum relative humidity	90% at 35°C
Maximum altitude	2000 m a.s.l.
Protection rating	IP20 (IP30 when installed)
Weight	580 g
VOLTAGE/ABSORPTION	
Maximum operating voltage	24V _{DC} with auxiliary power supply 48V _{DC} via PoE switch
Absorption during operation	350 mA @24V _{CC}
Absorption during stand-by	200 mA @24V _{CC}
Absorption during operation	260 mA @48V _{DC} PoE
Absorption during stand-by	180 mA @48V _{DC} PoE
DEVICES THAT CAN BE INSTALLED	
Maximum number	Up to 4 devices (total sum of devices, also different) per flat

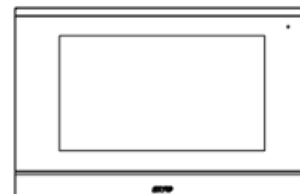

4.2.4 Indoor station with 10" touch screen LCD item TS-SMART10xx

The TS-SMART10ALS and TS-SMART10ANS devices are audio indoor stations of the AVE V44 SMART IP video intercom system.

The device can be powered by a 24VDC switching power supply (via the supplied cable) or directly by data cable via a 48 VDC PoE Switch.

The technical specifications of the indoor station with 10" Touch Screen LCD are given here below:

CHARACTERISTICS	
Height (mm)	187
Product width (mm)	240
Product depth (mm)	50
Display format	10" touch screen display - 1280 x 800 pixels
Connections to the following systems Smart home and Anti-intrusion	Via integrated Wi-Fi network. Wired connection on the RJ45 connector is possible if there is no video intercom system
CLIMATIC OPERATING CONDITIONS	
Temperature	-25 °C – +55 °C
Maximum relative humidity	90% at 35°C
Maximum altitude	2000 m a.s.l.
Protection rating	IP20 (IP30 when installed)
Weight	800 g
VOLTAGE/ABSORPTION	
Maximum operating voltage	24V _{DC} with auxiliary power supply 48V _{DC} via PoE switch
Absorption during operation	350 mA @24V _{CC}
Absorption during stand-by	200 mA @24V _{CC}
Absorption during operation	220 mA @48V _{DC} PoE
Absorption during stand-by	110 mA @48V _{DC} PoE
DEVICES THAT CAN BE INSTALLED	
Maximum number	Up to 4 devices (total sum of devices, also different) per flat

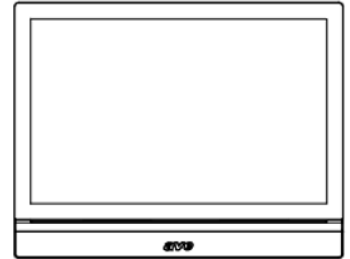

4.2.5 Indoor station with 18" touch screen LCD item TS-SMART18xx

The TS-SMART10ALS and TS-SMART10ANS devices are audio indoor stations of the AVE V44 SMART IP video intercom system.

The device can be powered by a 24VDC switching power supply (via the supplied cable) or directly by data cable via a 48 VDC PoE Switch.

The technical specifications of the indoor station with 18" Touch Screen LCD are given here below:

CHARACTERISTICS	
Height (mm)	278
Product width (mm)	399
Product depth (mm)	54
Display format	10" touch screen display - 1920 x 1080 pixels
Connections to the following systems Smart home and Anti-intrusion	Via integrated Wi-Fi network. Wired connection on the RJ45 connector is possible if there is no video intercom system
CLIMATIC OPERATING CONDITIONS	
Temperature	-25 °C – +55 °C
Maximum relative humidity	90% at 35°C
Maximum altitude	2000 m a.s.l.
Protection rating	IP20 (IP30 when installed)
Weight	2200 g
VOLTAGE/ABSORPTION	
Maximum operating voltage	24V _{DC} with auxiliary power supply 48V _{DC} via PoE switch
Absorption during operation	500 mA @24V _{CC}
Absorption during stand-by	250 mA @24V _{CC}
Absorption during operation	250 mA @48V _{DC} PoE
Absorption during stand-by	120 mA @48V _{DC} PoE
DEVICES THAT CAN BE INSTALLED	
Maximum number	Up to 4 devices (total sum of devices, also different) per flat

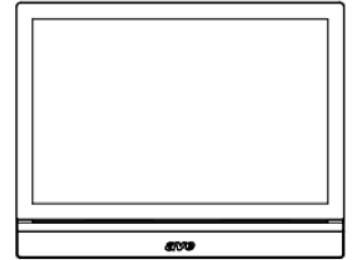

4.2.4.1 Installation

The devices should be installed at a height of 1.5 m from the ground.

TS-SMART7xx

The TS-SMART7xx is a wall-mounted device with a plate for installation on a horizontally recessed 3-module box. To install the device, screw in the supplied screws to secure the support bracket to the box. Once wiring operations have been completed, align the slots in the back of the monitor with the bracket hooks and slide the device slightly downwards.

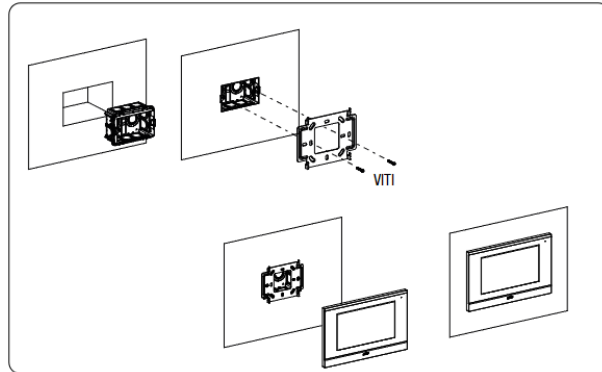

TS-SMART10xx

The TS-SMART7xx device is an in-wall device in a horizontally recessed 3-module box. Screw the screws supplied to secure the support bracket to the rectangular box, after it has been horizontally recessed. Once the wiring is complete, align the device to the plate and use the magnets on the back of the unit to bring it up to the hooking point. After it has been secured, slide the device to the right to engage the safety tab.

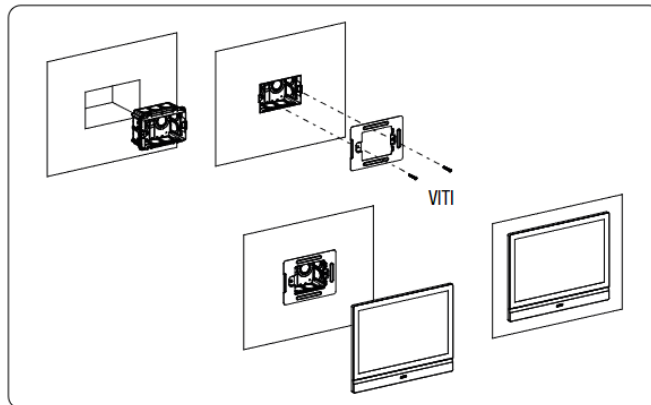

4.2.4.2 Device size

TS-SMART7xx

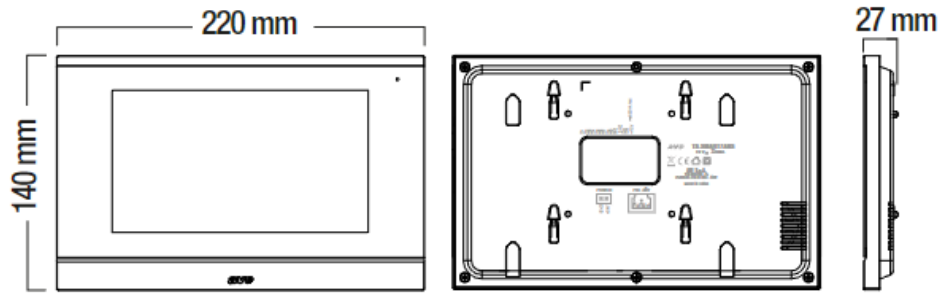

TS-SMART10xx

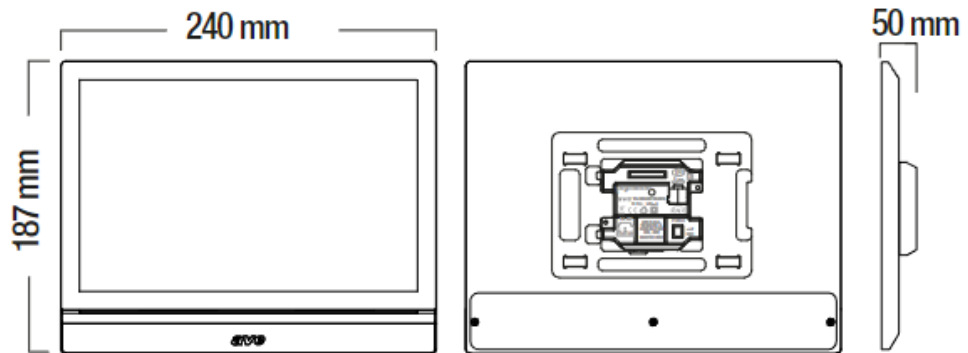

TS-SMART18xx

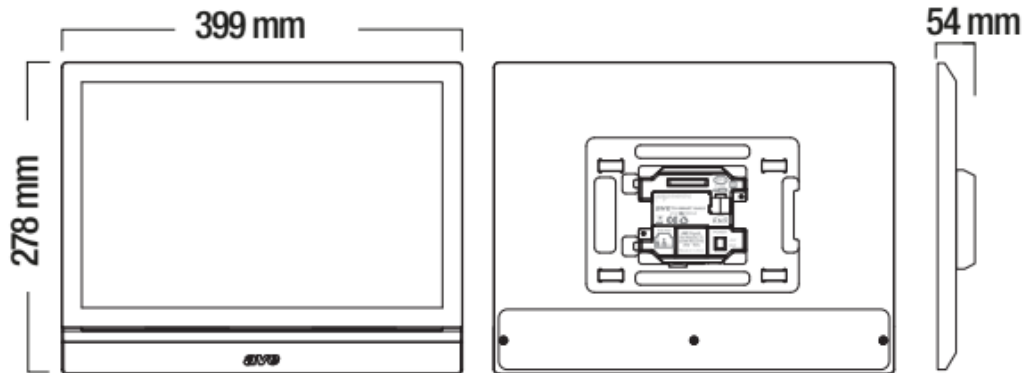

4.2.4.3 Connecting the devices

The TS-SMART7xx and TS-SMART10xx touch screens (indoor stations) can be powered in two ways:

- a. Via a standard PoE 48V_{DC} switch
- b. Via a stabilised 24V_{DC} power supply using the special cable supplied with the device by connecting it to "Power" terminal (check the correct polarity before connecting the connector).

It is not possible to use both power modes simultaneously as this may cause irreparable damage to the device.

4.2.4.4 Connecting the front door bell

The devices are supplied with a connector to connect the front door bell.

Connect a button with normally open contact (e.g. item 441005) to the connector. Pressing the button will cause the touch screen to emit an audible signal.

If there is more than one TS-SMARTxx in a flat, simply connect the doorbell button to one of them: when a call comes in, all devices will automatically start ringing.

4.2.4.5 Internal Parameters of TS-SMART7xx and TS-SMART10xx



The home page of the device can be divided into different chapters:

System Info

Part reserved for general device information and weather forecasts.

Weather information

Weather forecast.

If the device is connected to the internet, it can show the weather forecast for four consecutive days; this service is provided by Ilmeteo.it.

The weather information available is: weather forecast, minimum temperature, maximum temperature and current temperature of the selected location.

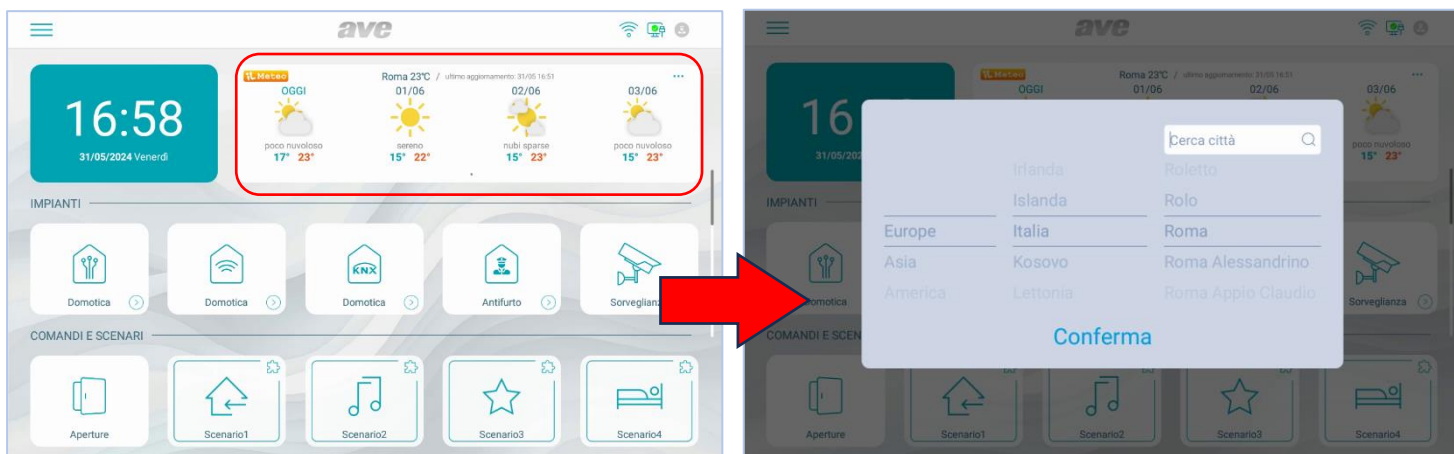

To select the city for which you wish to view the weather forecast:

1. Press the 3 dots in the top right-hand corner;
2. Enter the name of the desired location;
3. Press "Confirm";

The default city displayed by the device is Rome and the device provides the date and time of the last update.

System Apps

Management of the system's "advanced" functions (to be activated in the "Settings" menu, see the relevant chapter in the manual):

- **Domina Pro**: interfacing with the AVE DOMINA PRO home automation system;
- **Domina Smart**: interfacing with the AVE DOMINA SMART connected domestic range;
- **Anti-intrusion alarm**: interfacing with anti-intrusion alarm control units from the AVE AF927 range;
- **KNX Pro**: display of a web page generated by a KNX web server;
- **Video intercom**: management of the video intercom system;
- **Surveillance**: display of cameras at outdoor stations or IP cameras associated with the system;
- **Openings**: management of electromechanical locks at outdoor stations;
- **Call log**: received call log;
- **Muting**: button for muting the ringtone of the device. A red loudspeaker icon in the top left corner of the display indicates that the mute function is active;
- **Call forwarding**: enables the forwarding of an incoming call from an outdoor station. A white double arrow icon in the top left corner of the display indicates that the call forwarding function is active;
- **Surveillance**: opens the page displaying the cameras of the outdoor stations and any IP cameras associated with the system.

Configuration menu

On the device's home page, a "drop-down" menu can be accessed by dragging the three horizontal lines at the top of the LCD downwards to access various functions.

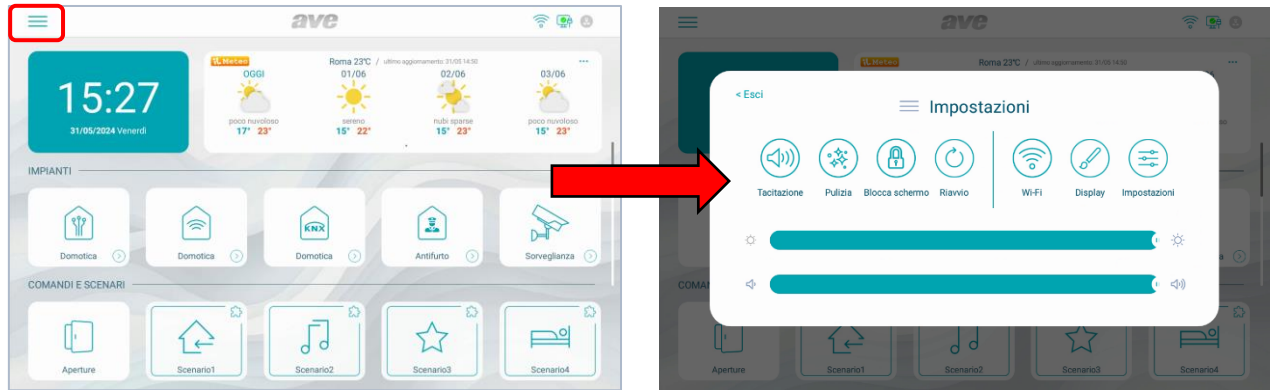

The following operations can be performed from the menu:

- **Muting:** to disable the audio and microphone of the device. A red loudspeaker icon in the top left corner of the display indicates that the mute function is active;
- **Wi-Fi:** to access the activation and configuration menu of the device's Wi-Fi network.
- **Display:** to access the configuration menu of the device display and the LED bar (only on devices with this feature).
- **Cleaning:** to activate the device's screen cleaning function. With the cleaning function active, the touch screen is disabled for 30 seconds, after which all functionality is restored.
- **Lock Screen:** if the function is enabled in the "Display" configuration menu, press this button to lock the touch screen; a password is required to unlock it. If an incorrect password is entered three times in a row, no further entries can be made for 60 seconds.
- **Reboot:** to reboot the device.
- **Brightness:** move the slider to the left to decrease the brightness of the display, and to the right to increase the brightness.
- **Volume:** move the slider to the left to decrease the volume of the device, and to the right to increase it.

From the menu, it is also possible to access all sub-menus and all device parameters by pressing the button:

- **Settings:** access to the device settings menu: Within the configuration menu, access to sub-menus containing the most critical parameters is password-protected.

Meaning of the configuration menu parameters

By accessing the system configuration menu from the drop-down menu on the home page, it is possible to access all the parameters of the device:

Date and time

Menu for setting the date and time of the device. The date and time can be set manually or, if the device is connected to the Internet, they can be updated automatically. Automatic updating of date and time inhibits manual configuration.

- **Automatic synchronisation:** if the device is connected to the internet, date and time are automatically synchronised.
- **Daylight saving time:** if activated, the device will automatically switch from winter time to summer time and vice versa.
- **NTP Server:** server from which the time is read automatically (do not change the setting).
- **Time zone:** time zone of the place where the device is installed.
- **12-hour format:** time displayed by the device in 12-hour or 24-hour format.

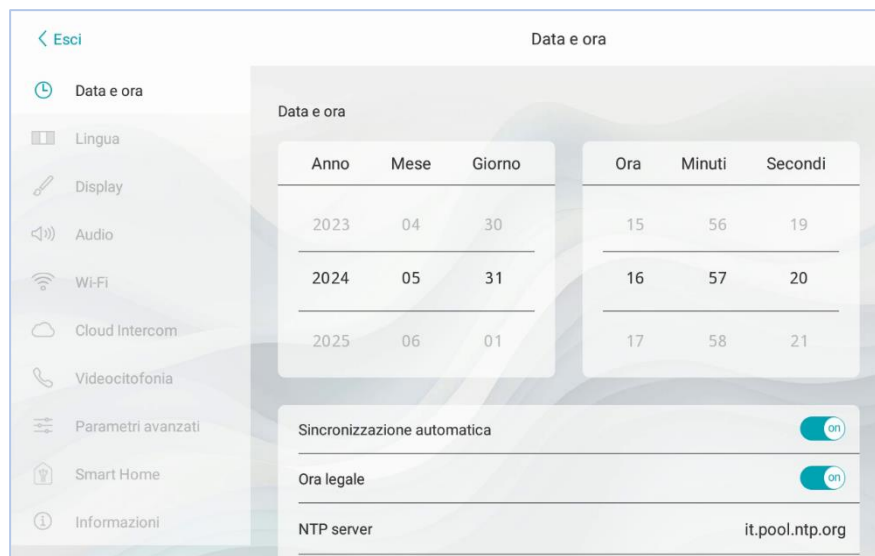

Language

Menu for system language configuration. Choose the desired language and return to the home page via the EXIT button

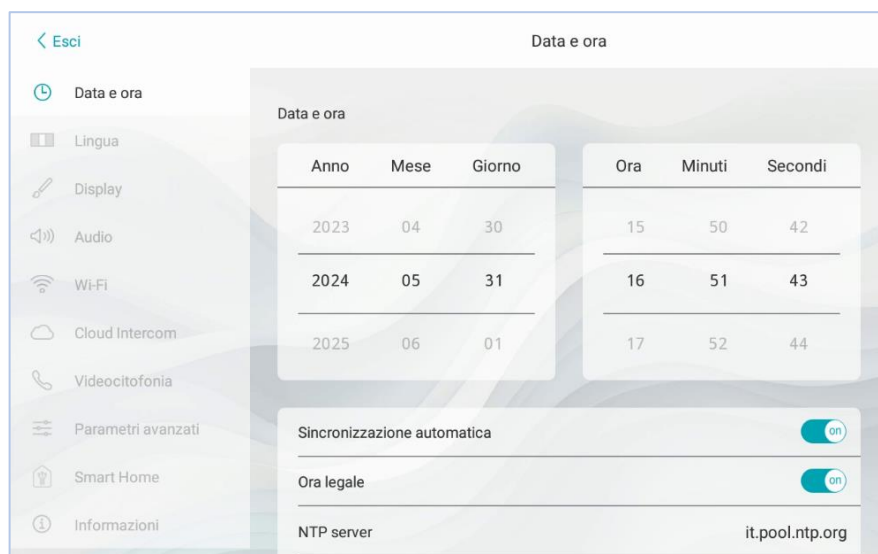

Display

Display settings configuration page .

- **Brightness:** move the slider to the left to decrease the display brightness, and to the right to increase the display brightness.
- **Temperature calibration:** parameter for setting the temperature offset (in tenths of a degree) of the internal thermostat (the temperature is displayed in the Info section of the Home page). By changing this parameter, it is possible to compensate for the difference in temperature reading due to the position of the device (e.g. in front of a sunlit window);
- **Screensaver:** selection of the screensaver image used by the device. Press the "add images from SD card" button to load additional images into the device via an SD card (not supplied and max. 32Gb) to be inserted into the SD card slot on the rear of the device.
- **The screensaver is activated after (sec):** number of seconds after which the screensaver is activated. Press the "+" and "-" buttons to increase or decrease the time.
- **The screen switches off after (min):** number of seconds after which the device screen is switched off. Seconds are counted from when the screensaver is switched on.
- **Screen Lock with Password:** activation of the screen lock function at the same time as the screensaver. The screen lock function requires the user to enter a password to unlock the device (the password must be set in the relevant menu below).
- **Light bar:** management of the LED bar on the front of the device (only available on TS-SMART10xx).

Light bar active with screen off: if the parameter is active, the LED light bar remains lit when the device screen is off. If the parameter is deactivated, the LED bar is switched off when the device LCD screen is off.

Stand-by: press the button to access the light bar configuration menu.

Enable: to enable the device light bar.

Light mode: it is possible to activate the light bar with static light or to create the "breathing" effect of the bar by selecting the "Dynamic" function.

RGB light bar: by moving the cursor within the colour field it is possible to choose the colour of the LED light bar.

Audio

Configuration of sound signals emitted by the device. For all parameters it is possible to increase or decrease the volume of the signal by moving the corresponding slider to the left (decrease volume) or to the right (increase volume).

- **Outdoor station:** press the "+" and "-" buttons to select from the ten available ringtones the one emitted when a call is received from the outdoor station.
- **Doorbell:** press the "+" and "-" buttons to select from the ten available ringtones the one emitted when the doorbell outside the door is pressed (floor bell).
- **Other:** press the "+" and "-" buttons to select the ringtone used by the device for every other alarm signal.
- **AVE alarm:** press the "+" and "-" buttons to select the ringtone used by the device for every other alarm signal (alarms, alarms from SMART HOME).
- **Voice call:** volume of conversation when calling from outdoor station.
- **Click on screen:** activation of a click when buttons on the screen are pressed.
- **Error tone if LAN cable is disconnected:** activation of a sound if the cable connecting the device to the data network is disconnected. This function should only be activated in specific cases where it is necessary to debug the data network functionality and only on request from AVE technical support.

Wi-Fi

Menu for activating and configuring the device's Wi-Fi card.

- **Wi-Fi:** on/off button for the device's Wi-Fi network.
- **Available networks:** list of networks found by the device. Press the "information" button to display the information about the Wi-Fi network in question; it is possible to disassociate it from the device by pressing the "Disassociate" button.

Cloud Intercom

Remote device management menu to the AVE VIDEO V44 APP for mobile devices with iOS and Android operating systems.

- **Associate:** display of the QR code to be scanned by the APP of the mobile device to be associated with the system.
- **Associated users:** page for viewing and managing the accounts associated with the system.
- **Enable AVE Cloud Intercom:** enables the communication between the device and the remote service server.
- **Checking the connection to the intercom cloud:** test button to check the connection of the device with the remote server.
- **Cloud intercom server address:** address of the remote server (do not change the parameter).

Video intercom

Settings of the device's video intercom functions.

- **Intercom:** activation of the "intercom" function between different flats. If this parameter is deactivated, the user will not be able to make or receive calls from other flats.
- **Automatic image capture:** automatic capture of the image sent by the outdoor station when a call is received.
- **Automatic recording:** automatic recording of an incoming call from an outdoor station.
- **Automatic electro-lock unlock:** "Doctor's office" function. The main gate (power electro-lock) is automatically activated upon receipt of a call from the outdoor station.
- **Automatic unlock set:** the parameter allows associating the automatic unlock with certain time slots.
- **SOS:** activation of the SOS function from the home page of the device. When the function is active, pressing and holding the SOS button on the main page activates an audible alarm signal on all indoor stations in the flat.

- **Call forwarding:** password-protected function (default password 666666).
To Concierge: forwards the call to the concierge (if present);
To an indoor station: forwards the call to another flat. To activate the function, enter the number of the building and flat to which the call is to be forwarded and press "OK" to confirm.
- **Relays:** activation on the Home page of the IP auxiliary relay management page.

Advanced Parameters

Password-protected menu (default 222222). Used to set the various system parameters (indoor station address, home page configuration, changing the password, resetting the device, etc.). Press the "OK" button to confirm any changes to the parameters. Changing one or more of the menu parameters may affect the correct operation of the system.

- **Indoor station address:** this button accesses the device's unique parameter configuration page:
 - Building:** building number. Parameter used when the system structure includes several buildings with a single outdoor station (e.g. block of flats). Normally, the parameter should not be changed.
 - Flat:** number of the flat within the building. The number must be progressive.
 - No.:** progressive number of the indoor station in the flat. If there is only one indoor station in the flat, the parameter should be set to 1. If there is more than one station, the number entered should be progressive 1, 2, 3, 4. The maximum number of touch screen monitors within a flat is 4; each device must have a unique ID.
 - Villa mode:** if activated, it eliminates the "Building" parameter from the menu, allowing the system to be used for a single house or block of flat.
- **Home Page Management:** configuration page of the home page of the device. The parameters on this page "populate" the Home page.

Access to the main interface

- Apps:** activation of the Apps section (Smart Home, Anti-intrusion Alarm, Video Intercom, etc.).
- Domina Pro:** activation of the button to access the interface to the AVE DOMINA PRO₍₁₎ system web server.
- Domina Smart:** activation of the button to access the interface to the root node of the AVE DOMINA SMART system.
- Anti-intrusion alarm:** activation of the button to access the anti-intrusion alarm control unit of the AF927₍₂₎ range.
- KNX Pro:** activation of the button to access a web page generated by a KNX web server₍₃₎.
- Video intercom:** activation of video intercom functions and incoming calls from the outdoor IP station.
- Call log:** activation of the button to access the log of incoming video intercom calls.
- Surveillance:** activation of the button for displaying the cameras of the outdoor station and any IP cameras connected to the system.
- Openings:** activation of the button for unlocking the electro-locks of outdoor stations.
- SOS Log:** by enabling this parameter, an SOS icon will appear in the top right corner of the home page which, when pressed, will cause all TS-SMARTxx units in the system to emit an alarm sound.
- Muting:** activation of the device's ringtone muting button.
- Call forwarding:** activation of the button to manage incoming call forwarding.

Enable AVE Bus scenarios

The parameters enable the buttons for quick activation of the home automation scenarios managed by the AVE DOMOTICA PRO system⁽¹⁾ on the Home page. A maximum of 4 direct buttons can be activated on the home page.

Configuration of the scenario button:

Activate the scenario button via the slider and associate:

- the name of the scenario that will be displayed on the home page;
- the icon displayed on the home page by selecting from those proposed by the system (it is not possible to import new icons);
- address previously associated with the scenario configured in the AVE DOMINA PRO system (from 01 to EF);

KNX: activation of the device interface enabling its direct interfacing with the KNX bus. For the KNX configuration of the device, please refer to the relevant guide.

General info: activation of date/time/temperature⁽⁴⁾ and weather information on the home page.

Note (1): This function is possible if item 53AB-WBS or an AVE device with integrated Web server is installed on the system.

Note (2): This function is possible if item AF927PLUS is installed on the system.

Note (3): This function is only available with the TS-SMART10xx device

Note (4): the temperature is measured by a thermometer that is only present on the TS-SMART10xx and cannot be integrated into the temperature control system of Domina systems.

- **Password:** page for changing user and administrator passwords. Access the password you wish to change, enter all required data and press "OK" to confirm the change.

User password: this password can be used to:

- unlock "Unlock 1" of the VIIP-PE7T outdoor station (default password 666666; this password should always be changed);
- enable call forwarding;
- Unlock the device when the password screen lock is on.
- Administrator password: allows unlocking the VIIP-PE7T outdoor station (default password 666666; this password should always be changed);

- **Factory reset:** total reset of the device to factory parameters.

Warning: all the information on the device will be erased and it will no longer be possible to retrieve it.

Smart Home

Menu for configuring interface parameters to advanced devices that can be integrated into the system.

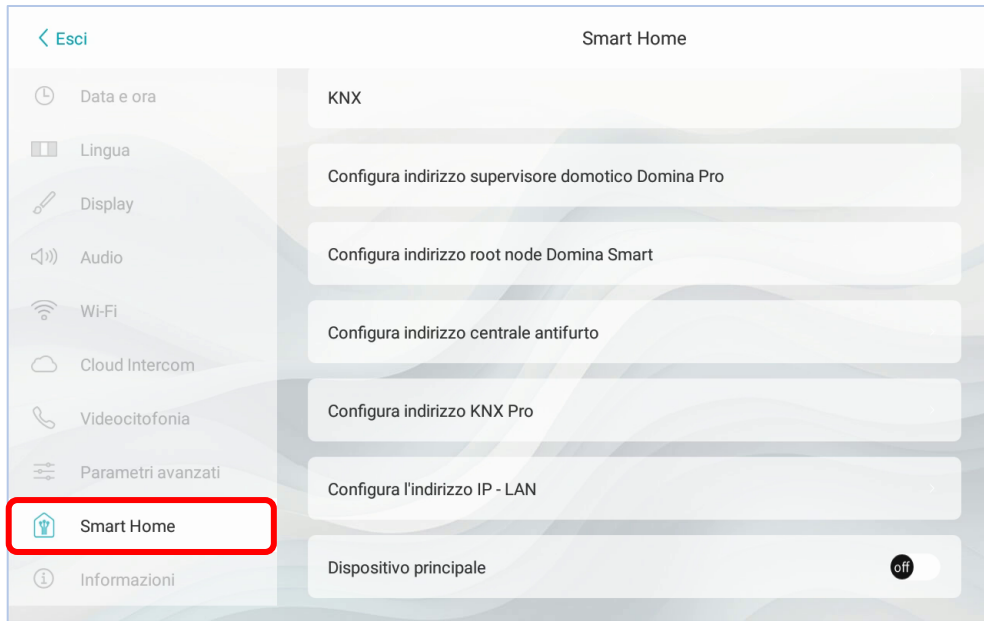

- **KNX:** see the KNX system configuration guide.
- **Domina PRO home automation monitor address configuration:** home automation monitor web server address. Press the "Default Address" button to reset the address to the default parameters 192.168.1.10. After each change, press the "Save" button to confirm.
- **Domina SMART root node address configuration:** address of the device configured as root node in the DOMINA SMART system. Press the "Default Address" button to reset the address to the default parameters 192.168.1.12. The address of the root node can be found via the AVE Cloud APP. This is done by checking the addresses of the devices in the field.
- **Anti-intrusion alarm control unit address configuration:** address of the anti-intrusion alarm control unit (AF927 range) installed on the system. Press the "Default Address" button to reset the address to the default parameters 192.168.1.11. After each change, press the "Save" button to confirm.
- **KNX PRO address configuration:** address of the KNX web server to be accessed in order to view the web pages generated by it. The address shown is purely indicative: the identification of the address assigned to the KNX web server is beyond the control of AVE products. Press the "Default Address" button to reset the address to the default parameters 192.168.1.13.

WARNING: The AVE TS-SMARTxx touch screen is a viewer of a web page generated by a KNX web server. AVE accepts no liability for KNX products installed in the system that are not manufactured by AVE.

- **Configure the IP-LAN address:** address of the LAN address of the device. This function is only active if the video intercom function is not used and configured on the system. If the video intercom system is active on the system, the connection to the home automation monitor and the anti-intrusion alarm control unit is only possible via the Wi-Fi data network. After each change, press the "Save" button to confirm.
- **Main device:** the activated parameter sets the indoor station as the communication device to the home automation monitor (web-server). If there is more than one indoor touch screen station in a system, this parameter should only be active on

one unit. If the parameter is active on more than one unit, this may cause the system to malfunction.

Information

Display page for device information (operating system version, network information, etc.).

1) INTERFACING WITH AVEBUS HOME AUTOMATION AND ANTI-INTRUSION ALARM SYSTEM

The touch screens can be interfaced with the AVEBUS home automation systems and the anti-intrusion alarm control units of the AF927 range via a data network.

If a video intercom system of the V44 SMART (IP) range is configured on the system, the connection between the touch screen, the home automation monitor and the anti-intrusion alarm control unit will necessarily be via the Wi-Fi network.

This is necessary to maintain a high level of security on the customer's network.

The video intercom part therefore operates on a different class of network from the connections to the home automation system and the anti-intrusion alarm system.

If there is no video intercom system, the connection between the touch screen, the home automation monitor and the anti-intrusion alarm control unit can also be made via the wired data network, using the connector on board the devices.

The touch screens are pre-set to communicate with the home automation system and the intruder alarm system (if activated).

The default parameters of the two systems are:

- a. **HOME AUTOMATION SYSTEM:** <http://192.168.1.10>
- b. **ANTI-INTRUSION ALARM SYSTEM:** <http://192.168.1.11>

It is always possible to restore the system's default parameters from the interface configuration page. Interfacing allows:

HOME AUTOMATION SYSTEM ⁽¹⁾:

- managing all home automation system functions (lights, dimmers, roller shutters, temperature control, etc.).
- receiving alarms from the home automation system, silencing them, clearing them.

ANTI-INTRUSION ALARM SYSTEM ⁽¹⁾:

- managing all the functions of the anti-intrusion alarm system (activation, deactivation, partialization, etc.).
- receiving alarms from the anti-intrusion alarm system; at the same time as an alarm tone is emitted, the LED bar starts flashing red.

Note⁽¹⁾: the touch screen is only a system display. The home automation monitor (web server) or the anti-intrusion alarm control unit manages all system functions and security. The absence of the touch screen does not affect the operation of the home automation and anti-intrusion detection systems, which will continue to manage their respective systems.

2) IP CAMERA ASSOCIATION

The system can display IP cameras (max. 64) if they are associated with the device. By accessing the "Surveillance" menu and then pressing the "View IP Cameras" button, it is possible to:

- Add a new IP camera:
 - Camera name: name associated with the camera;
 - RSTP address of the camera:
 - Add: button to confirm the operation;
 - Import the profile from the microSD:
- Change the parameters of an already inserted IP camera: go to the parameter to be changed, make the change and press the "Save" button.

Camera list: the list of cameras associated with the device is displayed. Press a camera icon to open the page displaying the images transmitted by that camera. To close the page, press the red button. Press the two arrows button to move from one camera to the next.

5. MISCELLANEOUS ITEMS

5.1 IP Relay item VIIP-RELAY

The device is an IP module with 2 monostable relays with N.C. and N.O. output contacts.

CHARACTERISTICS	
Height (mm)	89
Product width (mm)	35
Product depth (mm)	64.5
CLIMATIC OPERATING CONDITIONS	
Temperature	-10 °C – 55 °C
Maximum relative humidity	90% at 35°C
Maximum altitude	2000 m a.s.l.
Protection rating	IP20 (IP40 when installed)
Weight	94 g
OPERATING VOLTAGE	
Maximum operating voltage	24V _{DC} with auxiliary power supply 48V _{DC} via PoE switch
Absorption during operation	80 mA @24V _{CC}
Absorption during stand-by	40 mA @24V _{CC}
Absorption during operation	50 mA @48V _{DC} PoE
Absorption during stand-by	24 mA @48V _{DC} PoE
IN/OUT CONNECTIONS	
NC	Normally closed contact
COM	Common contact
NO	Normally open contact
CONNECTIONS 4 (RJ45)	

LAN cable connection PoE 48VDC

Device programming must be performed using the AVE V44 CONFIG configuration software. **Attention:** It is possible to associate only one function (among those listed below) with the VIIP-RELAY device: it is therefore not possible to configure, for example, relay No.1 as a call repeater and relay no.2 as an outdoor station auxiliary relay. If a primary power supply via PoE switch is used, make sure that the total power consumption of all IP devices is less than the maximum current that can be supplied by the switch.

The device can be configured in the following modes:

OUTDOOR STATION AUXILIARY RELAY

Up to two devices (4 total relays) associated with an external IP plate can be installed. The devices must be installed on the same data network where the external plates reside. The device automatically configures its own IP address (consistent addresses for association with the outdoor stations) and it cannot be changed.

Select via the software application:

- The closing time of each relay in the device;
- Building" or "Villa" function;
- The device ID (1-32 Building) (1-64 Villa);

Attention: in order for the video intercom outdoor station to control the VIIP-RELAY relays, the IDs of the relays to be managed must be specified in the configuration of the outdoor station from the V44 CONFIG software.

CALL REPETITION RELAY

It is possible to install 1 device for each apartment. The relay can be assigned an IP address such that the TS-SMART can detect it through the LAN network.

The association of the relay with an apartment can be configured using the V44 CONFIG configuration software: the relay must have the same apartment address as the indoor station.

The relay actuates the load associated with it when a call reaches the indoor station of the flat with which it is associated. The relays are closed according to the pattern shown below.

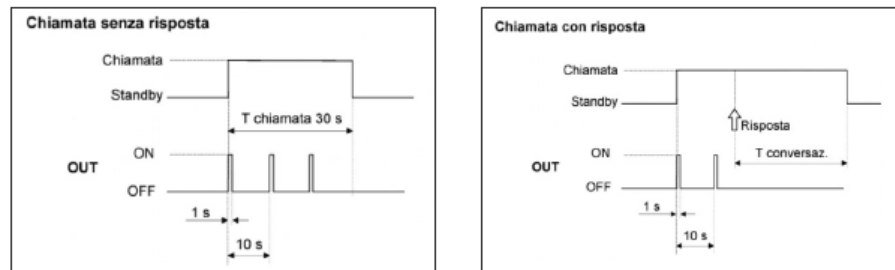

PRIVATE AUXILIARY RELAY

This function is available only in association with TS-SMART7, TS-SMART10, TS-SMART18 monitors; up to 10 relays can be associated with an apartment. The relays work in monostable mode: the contact closing time can be changed using the V44 CONFIG configuration software. “Private auxiliary relay” management requires:

- With the V44 SMART video intercom system: an IP address must be assigned to the relay such that the TS-SMART can detect it through the Wi-Fi network with which it is associated.
- Without the V44SMART SMART video intercom system: an IP address must be assigned to the relay such that the TS-SMART can detect it either through the wired LAN or through the Wi-Fi network with which it is associated.

For the configuration and management of the device from the TS-SMARTxx touch screen:

- Activate auxiliary relay management in the menu: Settings/Advanced Parameters/Main Page Management;
- On the home page, click on the "Relay" button;
- Press the "Add Relay" button and fill in all fields (enter as IP address the one previously associated with the VIIP-RELAY via the V44 CONFIG configuration software);
- Save the configuration;

To manage the auxiliary relays, tap on the “Relays” icon and tap on the icon corresponding to the implementation to be activated.

LOADS THAT CAN BE MANAGED BY RELAYS

The device can manage the following loads:

Ohmic load (cos 1)	6 A	CFL	100 W
Incandescent lamp	6 A	Electronic transformers	4 A
Fluorescent lamp	0.5 A	Motors	2 A
LED	100 W (check that the “inrush current” is within the described limits)		

5.2 48VDC PoE Switch item VIIP-SPOE

The product is a 48VDC PoE network switch. The device combines the functionality of a switch and a power source.

The device is equipped with 8 network ports, 2 Uplink ports and SFP connection port that can be used to connect a signal converter (e.g. fibre optic).

Communication protocol used: IEEE 802.3/ IEEE802.3u/x IEEE 802.3af/at

CHARACTERISTICS	
Height (mm)	46
Product width (mm)	200
Product depth (mm)	120
CLIMATIC OPERATING CONDITIONS	
Temperature	-5 °C – 55 °C
Maximum relative humidity	90% at 35°C
Maximum altitude	2000 m a.s.l.
Protection rating	IP20
Weight	1.8 kg
OPERATING VOLTAGE	
Maximum operating voltage	100/230 V _{AC}
Absorption during operation	<120 W
OUT CONNECTIONS	
Output ports	8 x 10/100/1000 Mbps
Uplink ports	2 x 10/100/1000 Mbps
SFP ports	1 port
Maximum output power	Total 120 W
Maximum output power	30 W per port
S-V Connector	S= standard 100m V= VLAN mode

6. INSTALLATION OF OUTDOOR STATIONS

The outdoor stations "mod. Villa" (items VIIP-PE1, VIIP-PE2, VIIP-PE4) can be installed on square/rectangular columns with a minimum side dimension of 100 mm.

Drilling jigs for the column are shown below for installation with the VI-BOX3C support plate or VI-RPBOX3 rain canopy.

N.B.

When installing inside a column, it is always necessary to install the in-wall box item VI-BOX3N.

6.1 Installation with outdoor station support plate

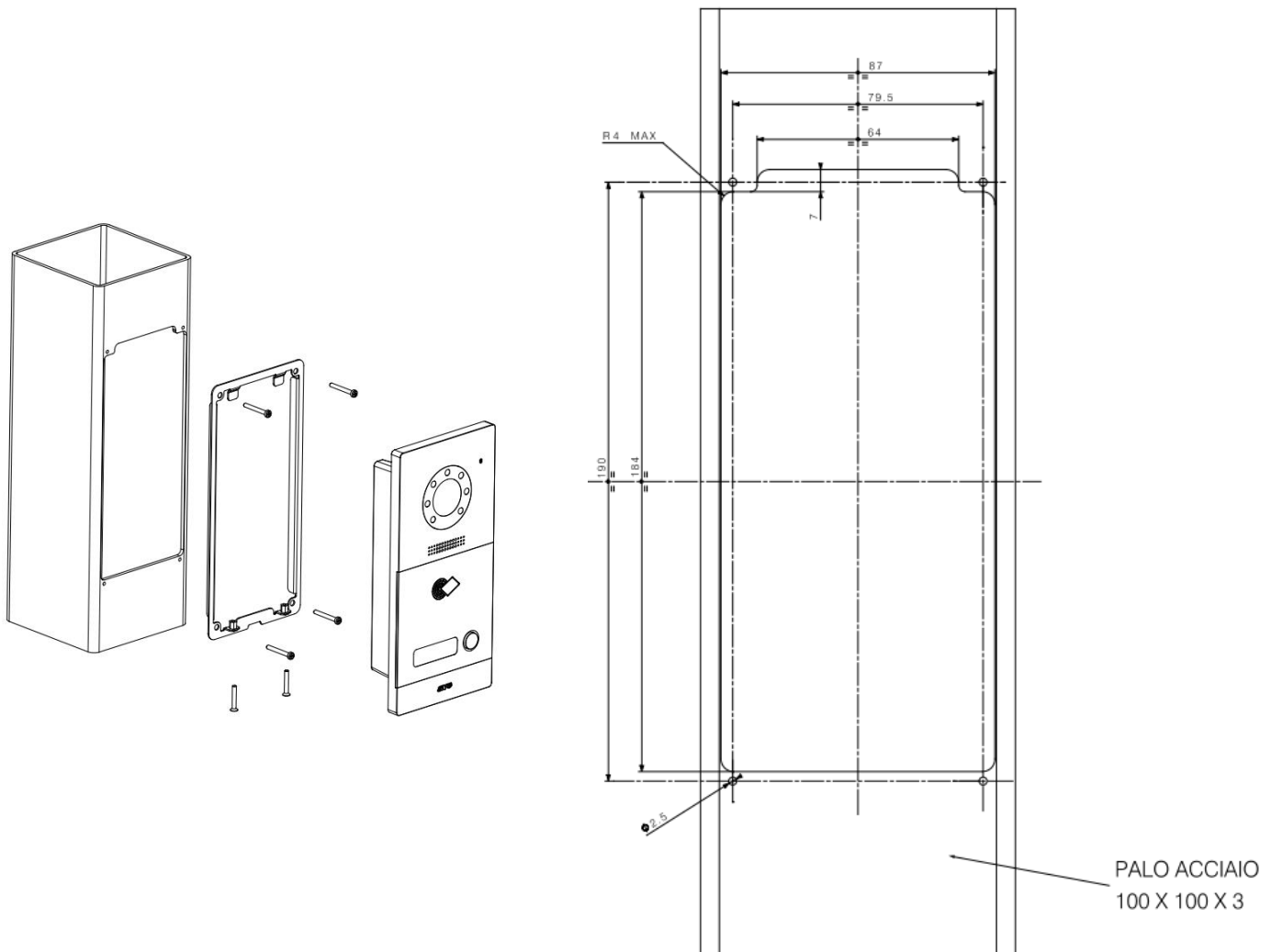

6.2 Installation with rain canopy

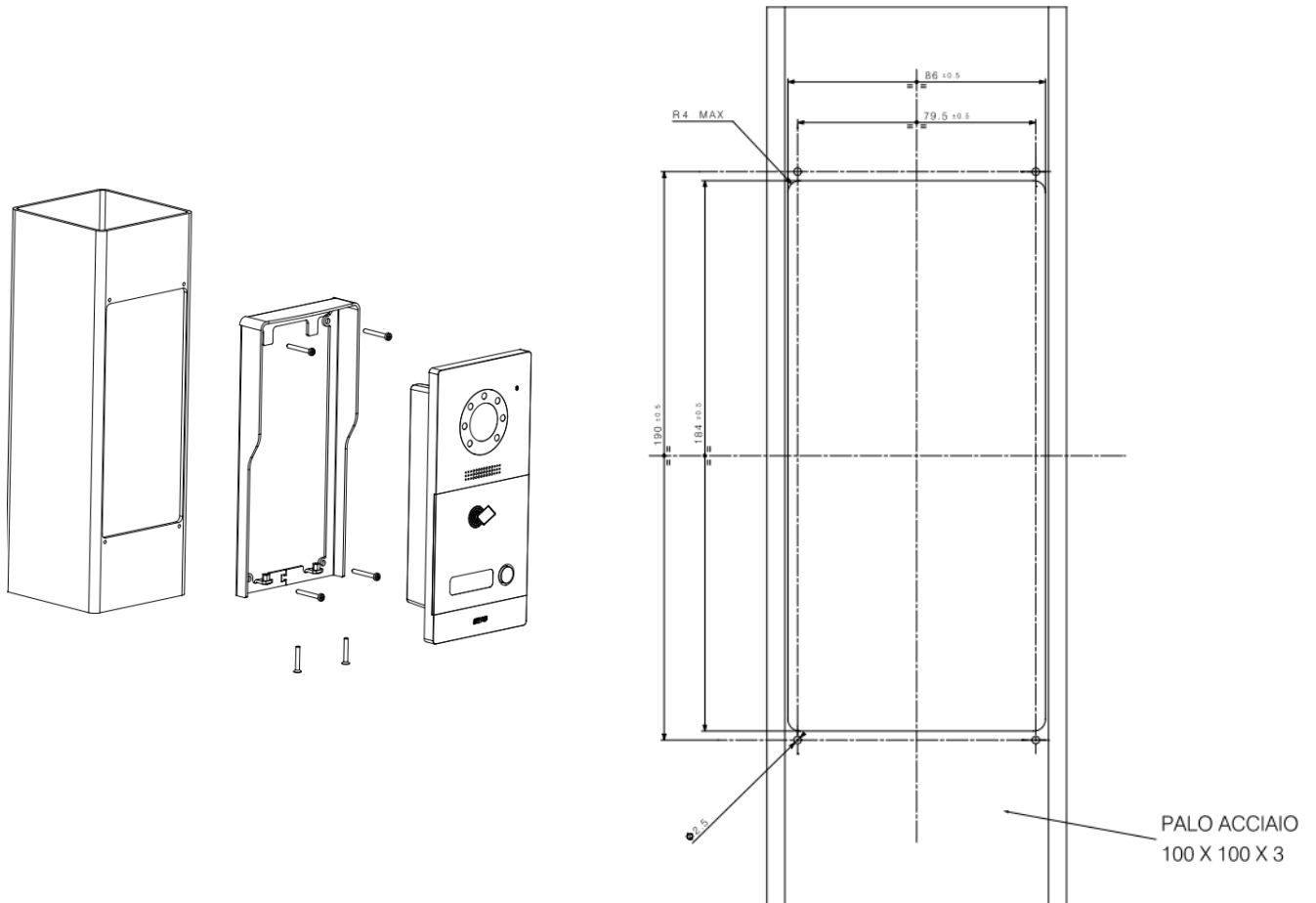

Multiple VI-BOX3N boxes can be coupled either horizontally or vertically.

The maximum number of coupled boxes is:

HORIZONTAL INSTALLATION: 5 VI-BOX3N boxes

VERTICAL INSTALLATION: 5 VI-BOX3N boxes

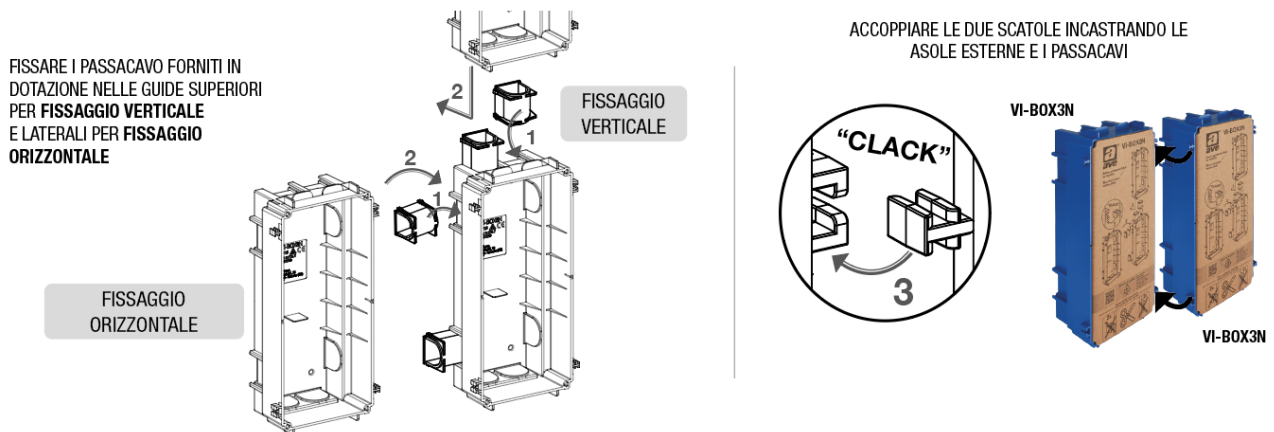

Check with the sales network for availability of rain canopies for installations of more than three horizontal and two vertical units.

7. CONFIGURATION OF MIFARE CARDS/TAGS

7.1 Card/tag programming

The system allows the management of the main relay of the outdoor stations (item VIIP-PE1, VIIP-PE2, VIIP-PET7) through the use of cards with MIFARE technology (item 44339CHU-MB or 44339CHU-MT).

Outdoor stations items VIIP-PE4 and VI-PEAUX do not support the card reading/programming function.

The maximum number of cards that can be managed is 200 (1 x MASTER + 199 x SLAVE).

There are two types of cards available:

- MASTER card: this is the system card through which other cards can be generated. To create USER cards, a MASTER card must have been created.
- USER cards: these are the cards to be given to customers and which will be used to open the gate

7.2 Creation of the MASTER card

The procedure for creating a MASTER card is outlined below:

- Disconnect the power supply from the outdoor station;
- Wait 30 seconds and reconnect the power supply;
- Within 60 seconds of switching the device back on, touch the card reader located on the outdoor stations (identified by the special logo on the front of the device) with a blank card (item 44339CHU-MB) and wait for a long confirmation "beep".

PROGRAMMAZIONE CARD MASTER

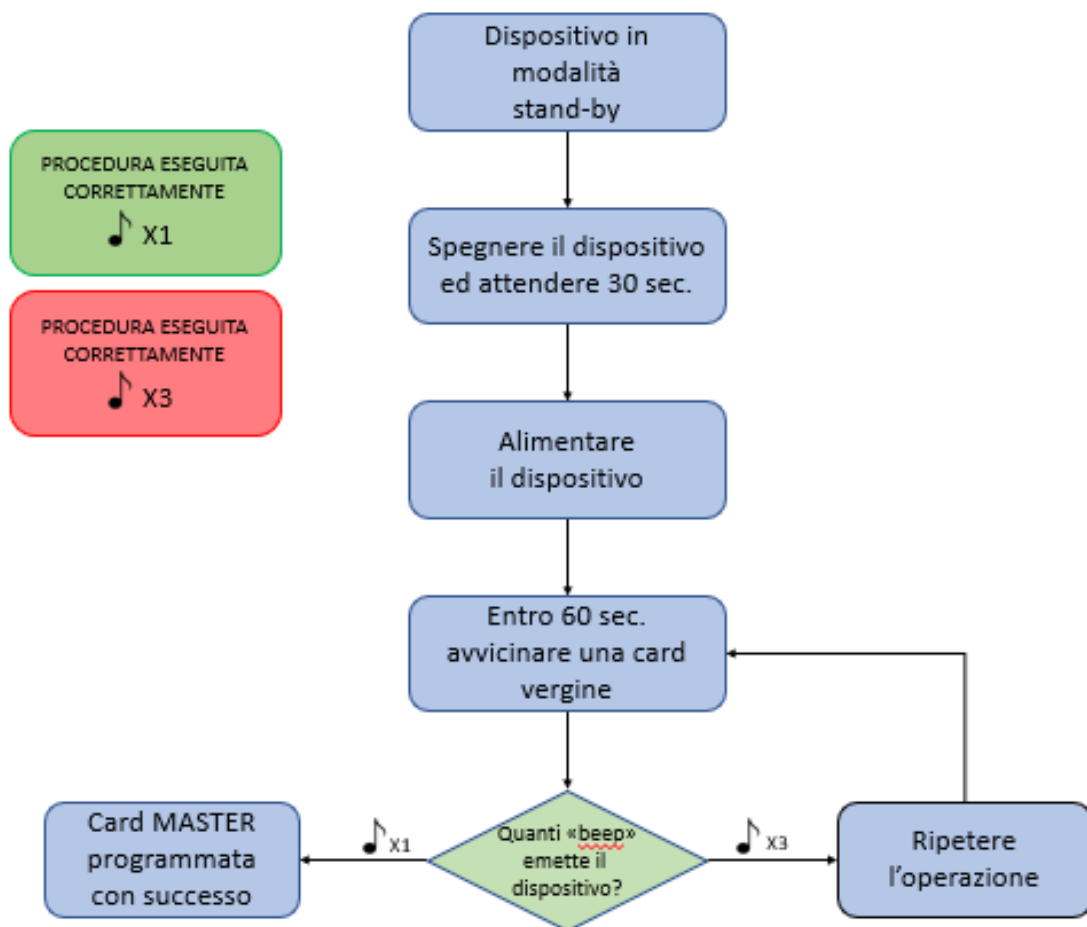

7.3 Accessing the Card Registration Menu

The system allows the management (programming and deletion) of user cards. To access these functions, it is necessary to enter the registration menu and select the operation to be performed.

The procedure for accessing the Card registration menu is as follows:

- a. In stand-by mode (system at rest), touch the card reader located on the outdoor station with the MASTER card: the device will emit a confirmation "beep".

ACCESSO AL MENU' REGISTRAZIONE CARD

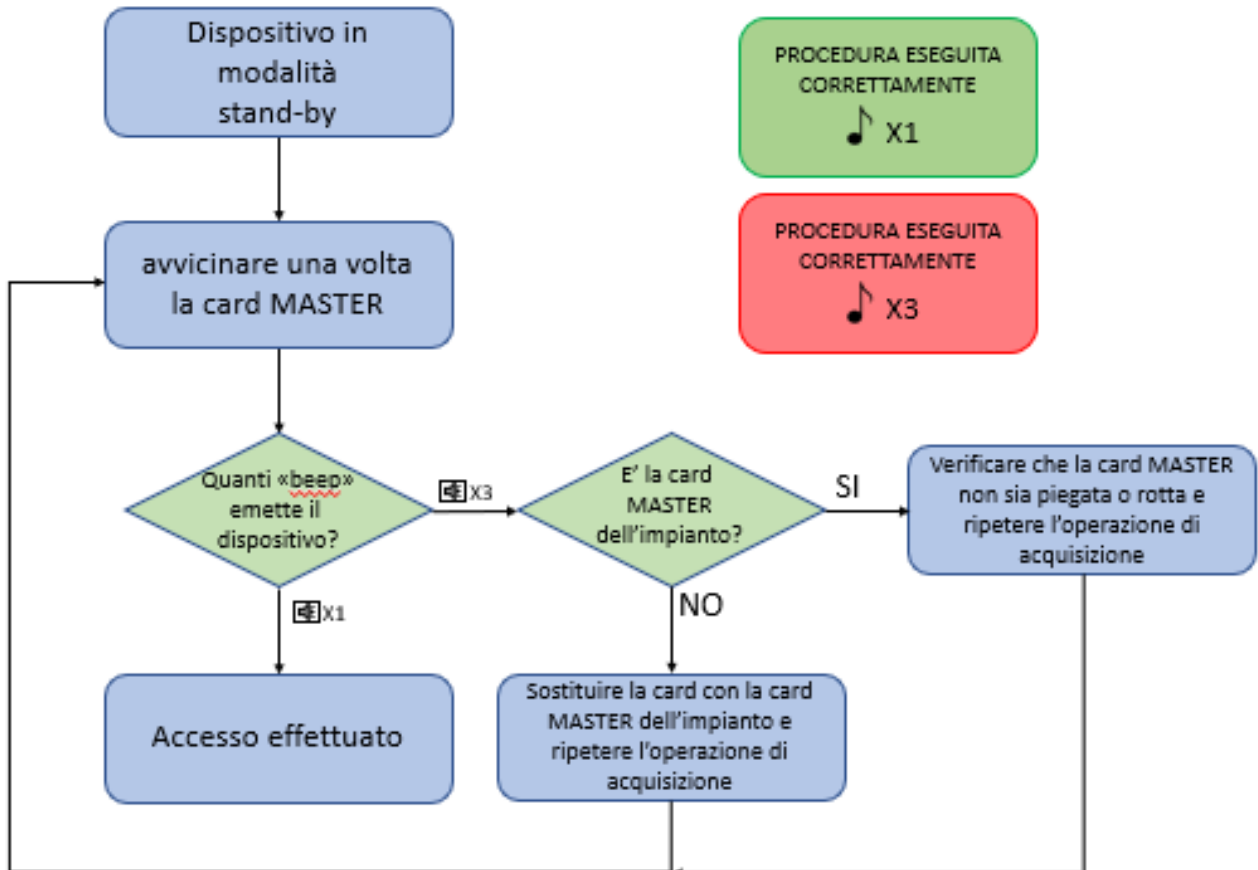

7.4 Creating a USER card

The procedure for creating a User card is outlined below:

- From the Card Registration menu, touch the card reader located on the outdoor station with the MASTER card **once**. The outdoor station will beep to confirm that it has entered "User Card Creation" mode;
- Within 15 seconds, touch the card reader with a blank card and wait for a "beep" to confirm the operation. Proceed with the other cards to be associated;
- If no operations are performed for 15 seconds, the system exits the user card programming procedure.
- At the end of the procedure, touch the reader with the MASTER card to exit the programming menu.

PROCEDURA DI CREAZIONE CARD UTENTE

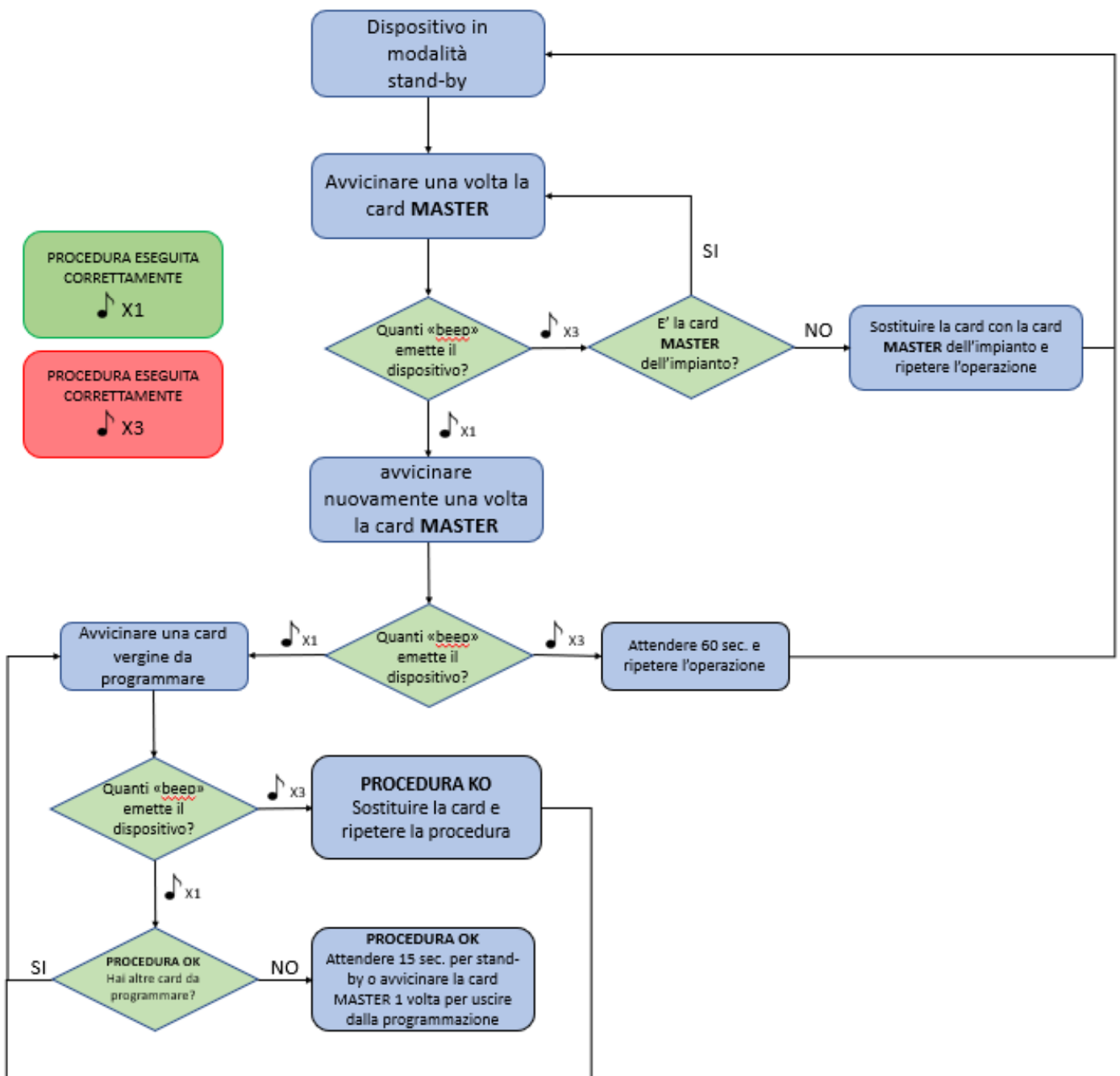

7.5 Deleting a USER card

The procedure for deleting a user card is set out below:

- From the Card Registration menu, touch the card reader located on the outdoor station with the MASTER card **twice**. The outdoor station will emit two "beeps" confirming that it has entered "user card deletion" mode;
- Within 15 seconds, touch the reader on the outdoor station with the card to be deleted. If the operation is successful, the device will emit a confirmation "beep" and will prepare for a new deletion;
- If no operations are performed for 15 seconds, the system exits the user card programming procedure.
- At the end of the procedure, touch the reader with the MASTER card to exit the programming menu.

PROCEDURA DI CANCELLAZIONE CARD UTENTE

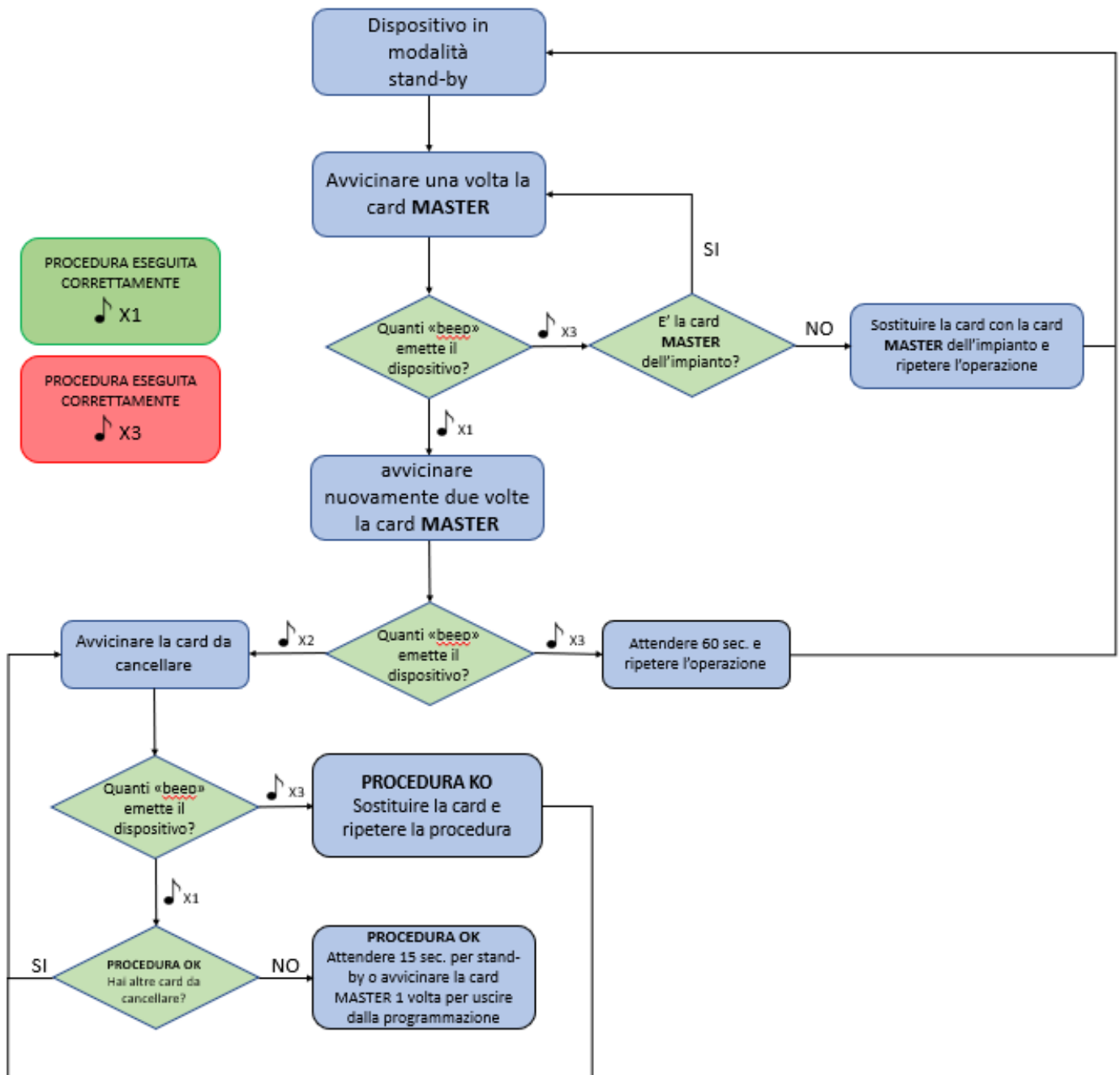

7.6 Creating a duplicate MASTER card

The procedure for creating several MASTER cards is outlined below:

- From the Card Registration menu, touch the card reader located on the outdoor station with the MASTER card **three times**. The outdoor station will emit three beeps confirming that access to the "MASTER card multiple creation" mode has taken place;
- Within 15 seconds, touch the reader with a blank card and wait for an audible signal confirming that the operation has been completed. Proceed with the other cards to be associated;
- If no operations are performed for 15 seconds, the system exits the user card programming procedure.
- At the end of the procedure, touch the reader with the MASTER card to exit the programming menu.

PROCEDURA DI DUPLICAZIONE CARD MASTER

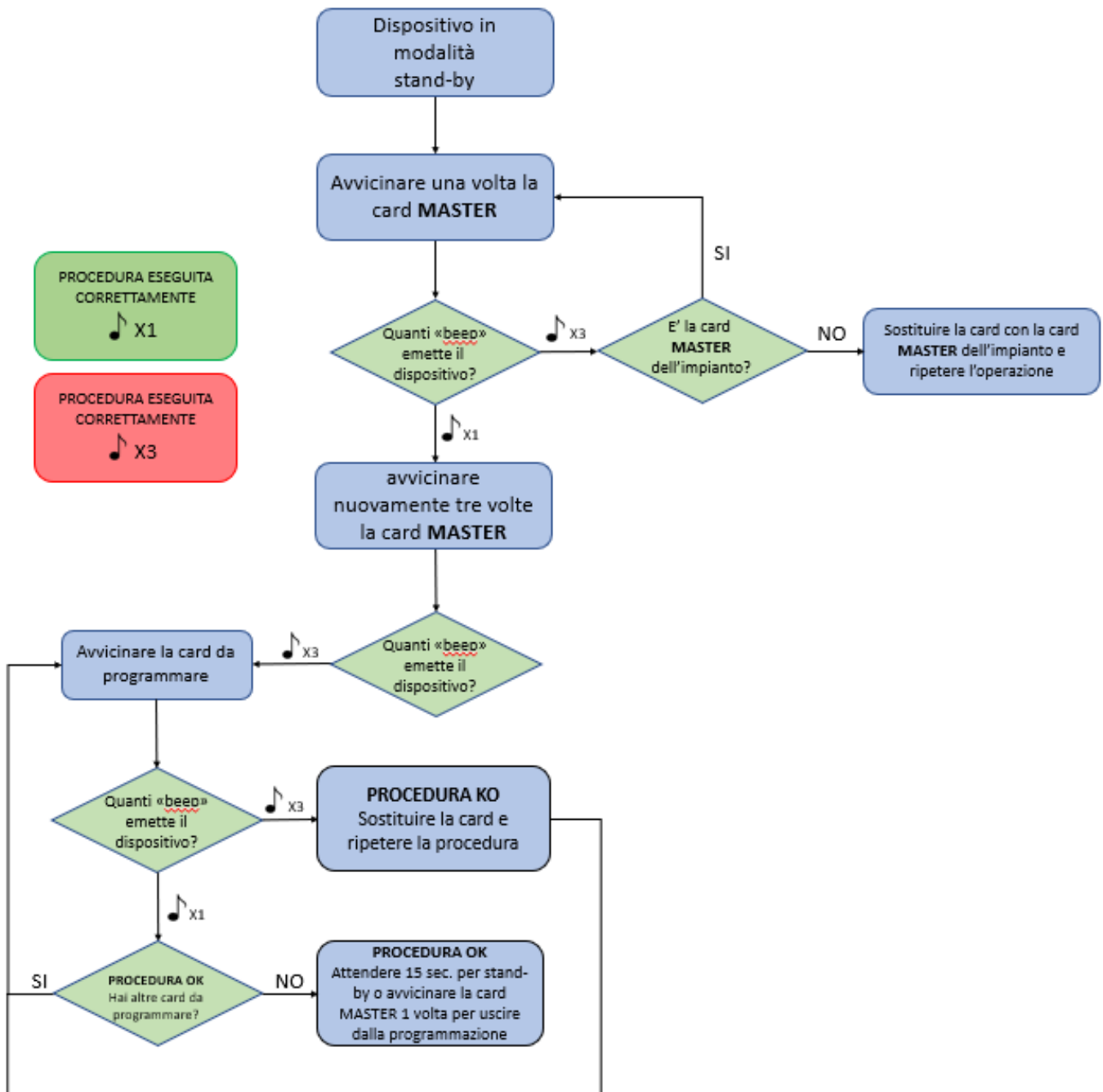

7.7 Cancelling all MASTER cards

The procedure for deleting all MASTER cards is outlined below:

- From the Card Registration menu, touch the card reader located on the outdoor station with the MASTER card **four times**. The outdoor station will emit four audible signals confirming that it has entered the "user card deletion" mode;
- Within 15 seconds, touch the reader on the outdoor station with the card to be deleted. If the operation is successful, the device will emit a confirmation tone and prepare for a new deletion;
- If no operations are performed for 15 seconds, the system exits the user card programming procedure.
- At the end of the procedure, touch the reader with the MASTER card to exit the programming menu.

PROCEDURA DI CANCELLAZIONE CARD MASTER

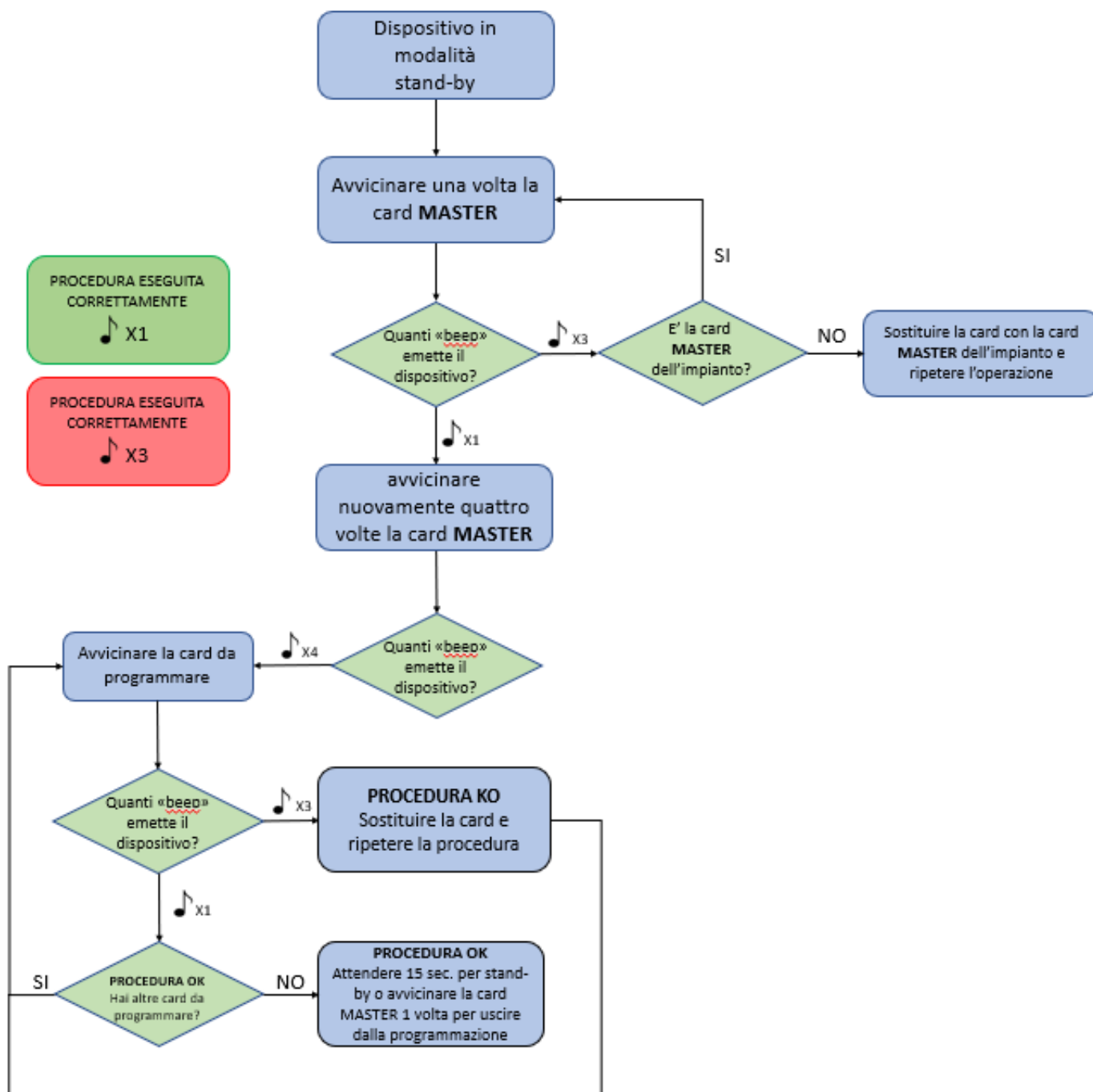

7.8 Deleting all USER cards

The procedure for deleting all User cards is outlined below:

- From the Card Registration menu, touch the card reader located on the outdoor station with the MASTER card **five times**. The outdoor station will emit ten audible signals confirming that it has entered the "user card deletion" mode;
- If the procedure is successful, the outdoor station will emit a beep
- An audible signal will sound and it will return to stand-by mode.
- If the procedure is unsuccessful, the outdoor station will emit three beeps and return to stand-by mode;
- If no operations are performed for 15 seconds, the system exits the user card programming procedure.
- At the end of the procedure, touch the reader with the MASTER card to exit the programming menu.

PROCEDURA DI CANCELLAZIONE DI TUTTE LE CARD UTENTE

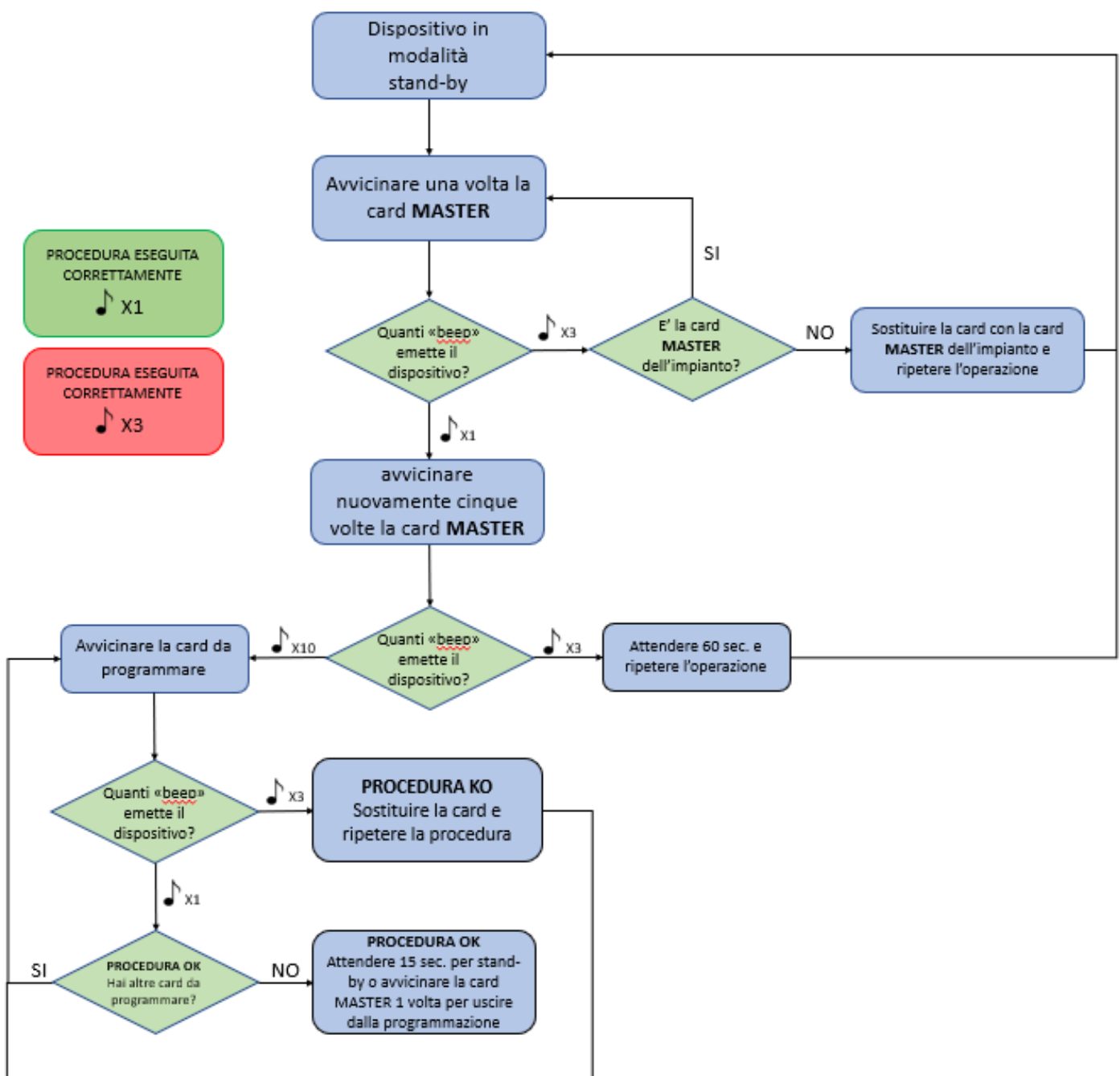

8. SYSTEM OPERATION

8.1 Calling from an outdoor station

Press one of the buttons on the outdoor stations to make a call to the corresponding indoor station.

- If the system is free, the call will be forwarded to the corresponding selected indoor station
- If the system is busy with another call, the outdoor station will emit three beeps to warn that the line is busy. Wait a few moments and repeat the operation.

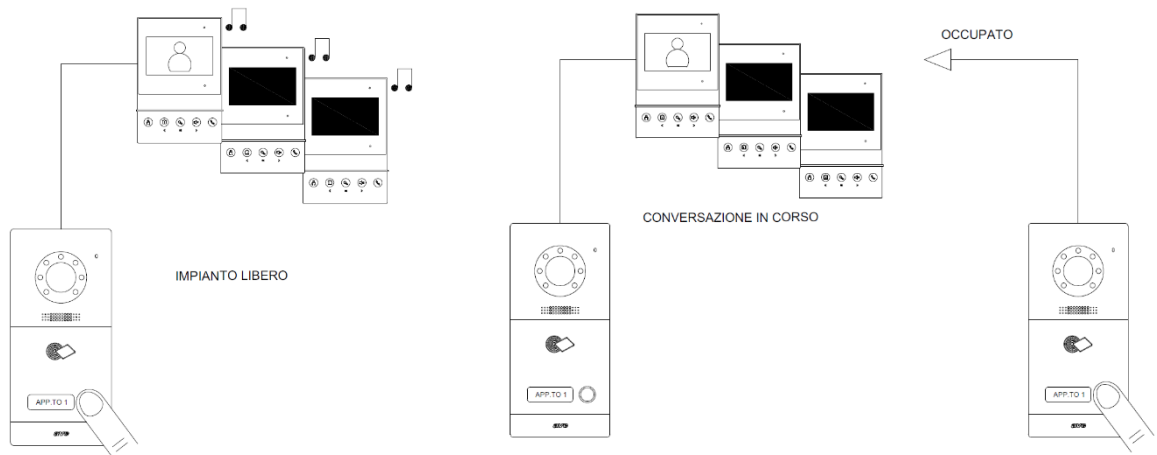

ATTENTION: if the call button is held down for more than 2 seconds, the call is cancelled. This behaviour is a feature of the system to prevent malicious persons from blocking the system by holding down a button with a "foreign body".

To make a call from the outdoor station with LCD, proceed as follows:

- a. Name list mode: press on the name corresponding to the desired extension; to move from one page to another, press on the arrows at the top of the screen;
- b. Numeric keypad mode: enter the number of the desired extension (if known) and press the handset button. If the extension is not known, it is possible to display the list of extensions by pressing the "figure" button (located at the top of the screen); scroll through the list of extensions and select the desired one.

8.2 Answering a call

When receiving a call from an outdoor station, the system behaves as follows:

- a. 4.3" Touch Screen (item VIIP-PIT4B): the LCD of the device displaying the camera from which the call originated is activated. To answer the call, press the "handset" button.
- b. Handset (item VIIP-PICAB): emits the call in progress tone. To answer the call, pick up the handset.
- c. TS-SMART7xx and TS-SMART10xx: the LCD of the device displaying the camera from which the call originated is activated. To answer the call, press the "handset" button.

When a call is answered, all other indoor stations with the same address stop ringing.

If more than one indoor station is installed in a flat, the system will behave as follows: all installed indoor stations (to which the call has been forwarded) will start ringing and all the LCDs of the devices will light up and display the camera of the calling video intercom station.

Answering a call from one device will establish a conversation to it; all other internal stations will stop ringing.

8.2.1 Meaning of the TS-SMARTxx buttons

Below are the meanings of the buttons on the call screen:

OUTDOOR STATION: device from which the call was made
22: seconds remaining until the call is ended

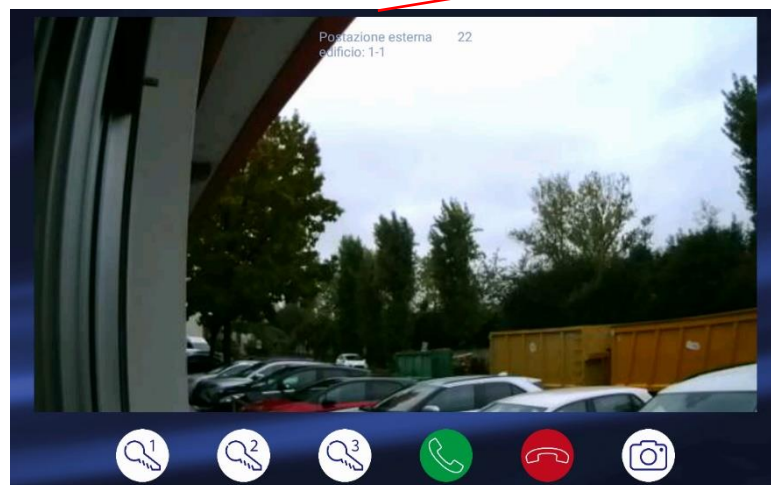

KEY BUTTON 1: power relay closure (e.g. pedestrian gate)
KEY BUTTON 2: dry contact relay closure (e.g. driveway gate)
KEY BUTTON 3: auxiliary dry contact relay (optional) closure (e.g. driveway gate)

GREEN HANDSET BUTTON: Answering a call
RED HANDSET BUTTON : rejecting a call
CAMERA BUTTON: capturing the image displayed on the LCD.

The incoming call ringtone lasts 30 seconds, after which the call is automatically rejected. The ongoing call is automatically ended 120 seconds after being answered.

Note:

Press the unlock buttons of the electro-locks (keys 1, 2, 3) to activate the associated relay, both when the bell rings and during the call.

Press the call answer button (green handset) to change the list of buttons on the page; the "Mute" (Microphone) button appears.

The "Mute" button allows muting the device's microphone, preventing your voice from being heard from the outside.

The meaning of the other buttons on the screen remains unchanged.

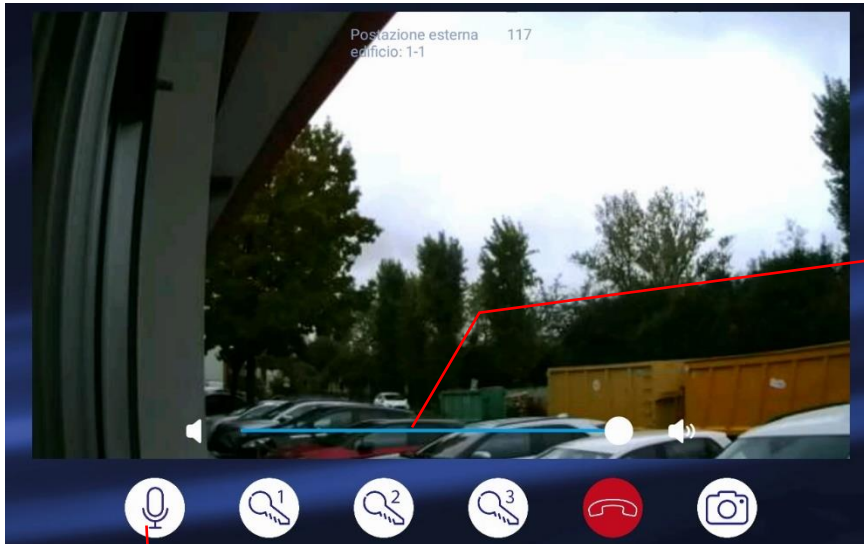

VOLUME BUTTON: adjusts the volume of the call. Move the slider to the left to decrease the volume and to the right to increase the volume.

MUTE BUTTON: when the microphone of the device is muted, the voice of the speaker from the outdoor station can no longer be heard from the indoor station.

8.2.2 Intercom call between several flats with TS-SMARTxx

With the AVE V44 SMART system, intercom calls can be made between indoor stations ⁽¹⁾ in different flats. This function is only possible if the indoor stations are part of the same data network and if the intercom function is active on them ⁽²⁾.

In order to make intercom calls, proceed as follows:

1. access the menu by pressing the "Video intercom" and then "Intercom" buttons:

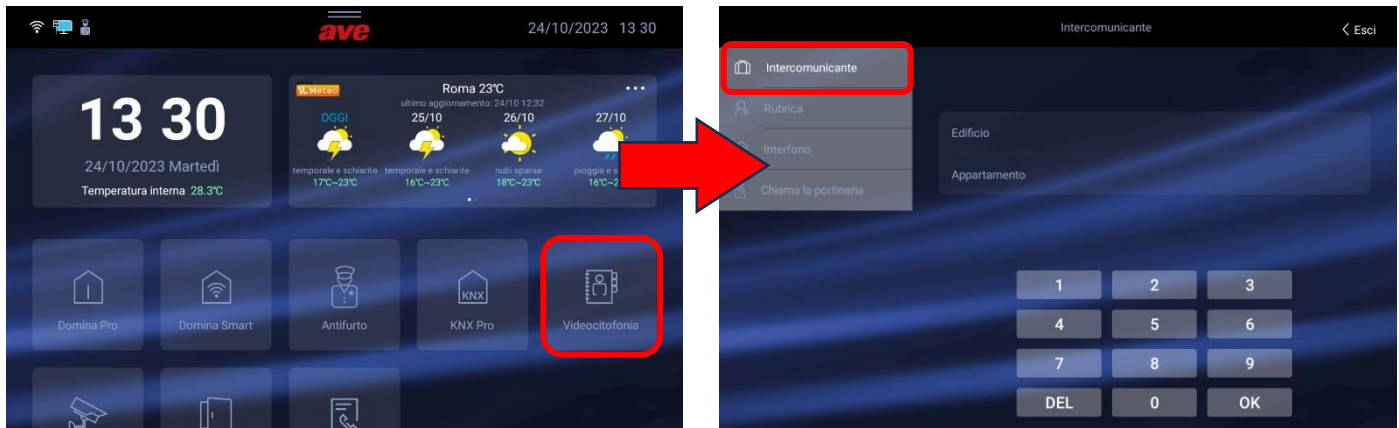

2. Enter the building and flat number of the person you want to contact (e.g. Building 1, flat 2).
3. Press the "OK" button to make the call.

Note ⁽¹⁾: all monitors can make and receive an intercom call while the handset can only receive intercom calls.

Note ⁽²⁾: the intercom function can be activated by scrolling down the drop-down menu on the Home page, then accessing the "Settings/Video Intercom" menu and finally activating the "Intercom" parameter.

8.2.3 Intercom call between several flats with VIIP-PIT4B

From a VIIP-PIT4B

- a. Switch on the LCD, use the arrows to select the "Call" button and confirm using the "OK" button;
- b. Use the arrows to scroll to the "Intercom" button and press the OK button;
- c. Use the arrows to select the indoor stations to be called and confirm with the "OK" button.
- d. Press the "call all" button to forward a call to all devices in the flat (pressing the "call all" button immediately activates the intercom function).

If the line is:

- a. free: the call will be forwarded to the selected indoor station;
- b. busy: the indoor monitor switches off and the intercom call is not forwarded.

Note:

A call from an outside station always has priority over an intercom call.

If a call is received from an outdoor station during an intercom call between indoor stations, the intercom call is immediately terminated, to allow the priority call to be answered.

8.2.3 Intercom call within the flat from TS-SMARTxx

If several devices are installed within a flat, intercom calls can be made between them (1). In order to make intercom calls, proceed as follows:

1. access the menu by pressing the "Video Intercom" and then "Intercom" buttons:

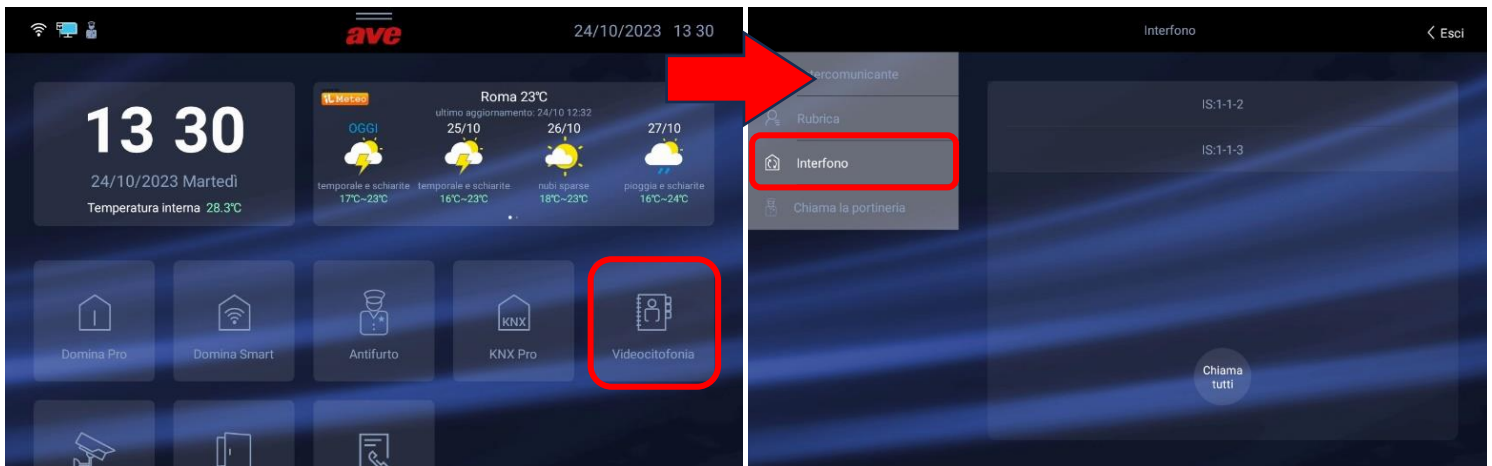

Note (1): all monitors can make and receive an intercom call while the handset can only receive intercom calls.

On the right-hand side of the device screen, the indoor stations belonging to the same flat are displayed, with which the touch screen can communicate.

2. Select the indoor station to be called from the list by pressing the corresponding button. When the button is pressed, the called indoor station will start ringing.
3. It is also possible to make multiple simultaneous calls to all internal stations in the flat by pressing the "Call All" button. All indoor stations in the flat will automatically initiate communication without ringing.

The call can only be ended from the station from which it was initiated.

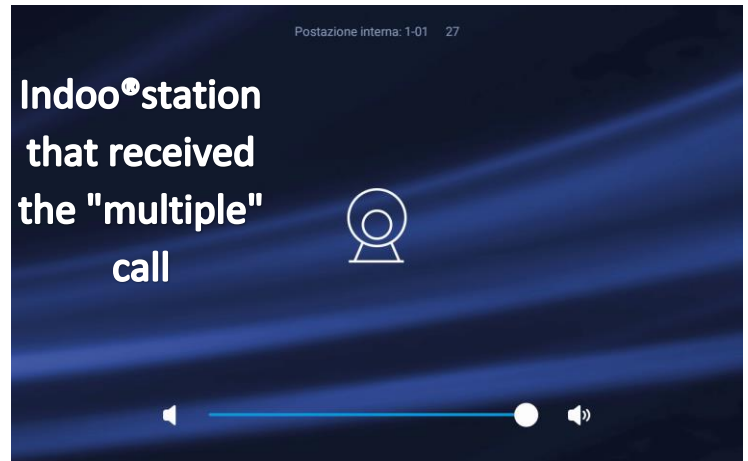

8.2.4 Calling the Concierge from TS-SMARTxx

If there is a concierge service in the system where the VIIP-GUARD station is installed, it can be called directly.

In order to make intercom calls, proceed as follows:

1. access the menu by pressing the buttons "Video Intercom" and then "Call Concierge";

2. A call to the concierge will be initiated; the call can be ended by pressing the red handset button.
3. By pressing the "Camera" button, it is possible to view the image coming from the video camera on the indoor concierge station.

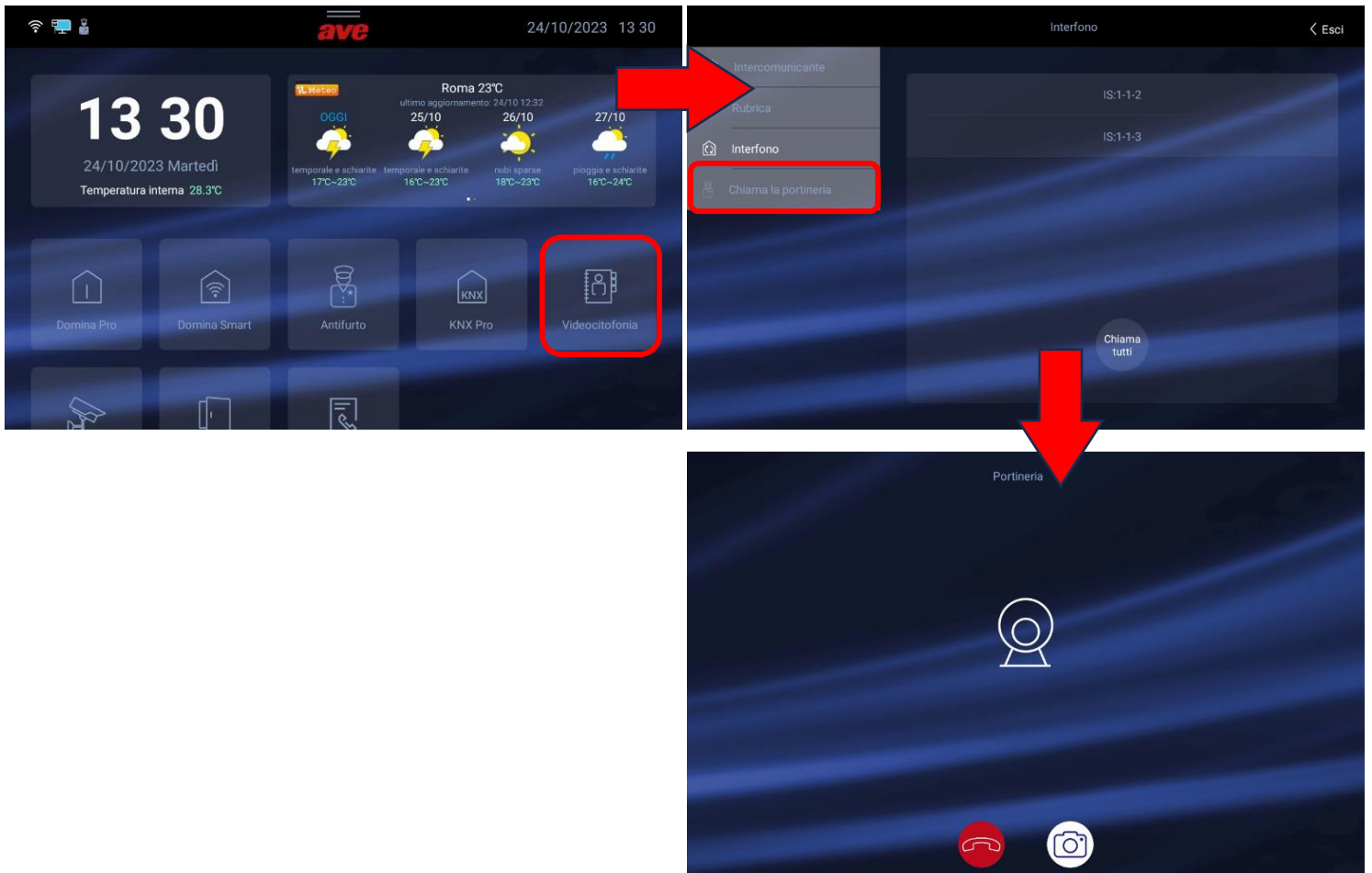

8.3 Door opener function

The door-opening function allows the management of electro-locks connected to an outdoor station regardless of the model.

The outdoor stations allow the opening of 2 gates with two contacts directly on board and of auxiliary IP relays (item VIIP-RELAY).

There is an input (DOOR) on the outdoor stations which, when connected via a push-button (type ref. 441005) referenced to 0V_{DC}, makes it possible to close the power contact on the same.

Below are the procedures for managing the gates from the various indoor stations:

8.3.1 Item VIIP-PIT4B

It is possible to manage the opening of a gate in two different situations:

- **With a call in progress**

During a call, it is possible to control the two relays on board the device by pressing:

- a. The key button for <1 second to control the first relay (Figure 1);
- b. The key button for >3 seconds to control the second relay (Figure 2);
- c. The "Letter" button to control the auxiliary relay (if installed).

- **With system at rest**

With the system at rest, it is possible to control the two relays on board the device by pressing the "figure" button and then:

- a. The key button for <1 second to control the first relay (Figure)
- b. The key button for >3 seconds to control the second relay (Figure 2)
- c. The "Envelope" button to control the auxiliary relay

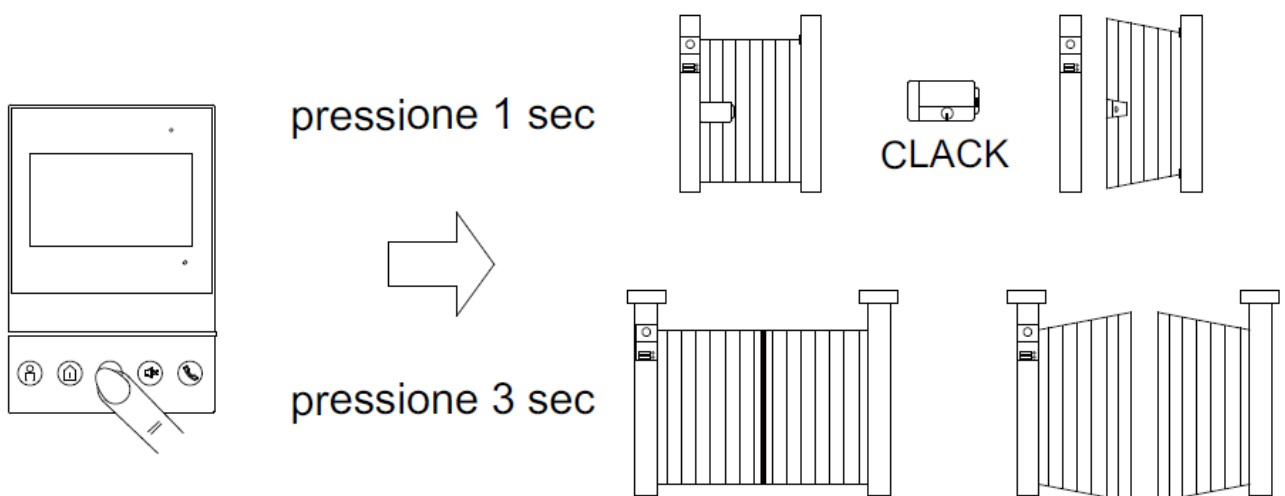

8.3.2 Item TS-SMARTxx

To open the various gates (pedestrian gate, driveway gate, etc.), proceed as follows:

1. Press the "Openings" button on the device's home page to access the menu;
2. Wait for the name of the outdoor station being called up to appear (approx. 1 second from the opening of the page to allow the dialogue between the devices to be established);

If there is more than one outdoor station on the system, an arrow will be displayed to allow moving between devices;

3. Press the button corresponding to the gate to be unlocked (1-6). The buttons have the following meaning:

BUTTON 1: used to unlock the power electro-lock (power relay on board the outdoor station);

BUTTON 2: used to unlock the dry contact electro-lock (dry contact relay on board the outdoor station);

BUTTON 3: used to unlock the dry contact electric lock (dry contact auxiliary relay, optional installation and not supplied with the outdoor station);

BUTTON 4: used to unlock the dry contact electric lock (dry contact auxiliary relay, optional installation and not supplied with the outdoor station);

BUTTON 5: used to unlock the dry contact electric lock (dry contact auxiliary relay, optional installation and not supplied with the outdoor station);

BUTTON 6: used to unlock the dry contact electric lock (dry contact auxiliary relay, optional installation and not supplied with the outdoor station);

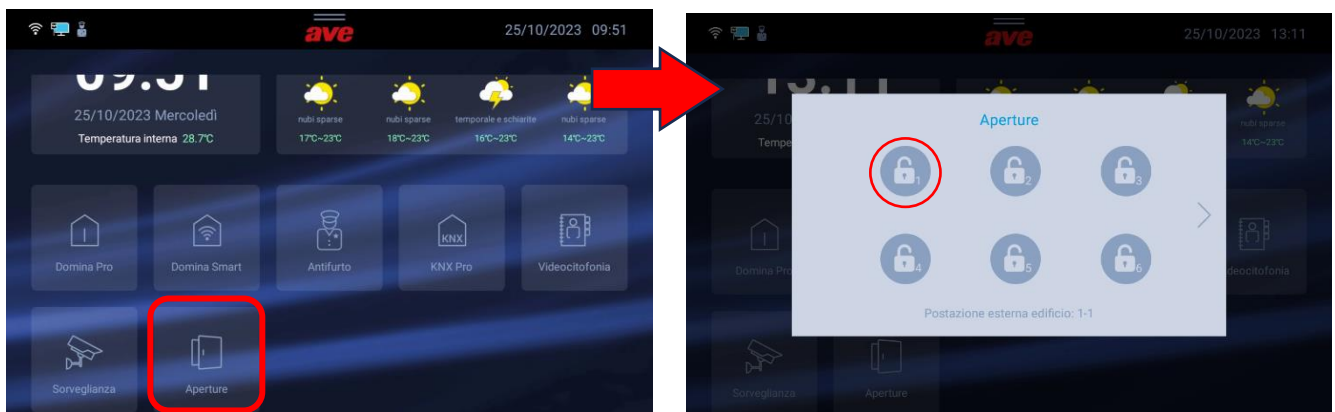

8.4 Door opener function with unlock code

If VIIP-PE7T outdoor stations and TS-SMART7xx and/or TS-SMART10xx are installed on a system, it is possible to use a code to unlock the power electro-lock "Unlock 1".

The opening code is set at the indoor station in the parameter Settings/Advanced Parameters/User Passwords.

8.5 Opening by means of a user card

The door connected to the outdoor unit can be opened simply by touching the reader with a card (item 44339CHU-MB) or a tag (item 44339CHU-MT) previously associated with the system (see the relevant procedure in this document).

The system allows the association of 50 cards on VIIP-PE1, VIIP-PE2 and of 1000 cards on VIIP-PE7T.

The card programming procedure is illustrated in the relevant chapter.

8.6 AUTOMATIC DOOR OPENER FUNCTION (Doctor's Office Function)

The "Automatic Door Opener" function allows relay No. 1 to close immediately on receipt of a call from an outdoor station.

The function must be activated in the relevant menu and remains active until it is switched off by the customer.

A "Key" icon is displayed on the LCD of the TS-SMART7xx and TS-SMART10xx indoor stations to indicate that the "Doctor's Office" function is active.

The VIIP-PICAB and VIIP-PIT4B indoor stations do not allow the use of the "Doctor's Office" function.

8.7 Mute mode (Mute Function)

The "mute mode" turns off the indoor stations' ringtone when a call is received from any outdoor station.

When the Mute function active, an incoming call is signalled as follows:

- a. Handset (item VIIP-PICAB): no signal; it is recommended to set the volume to minimum;
- b. 4.3" indoor station (item VIIP-PIT4B): LCD power on with special icon indicating that the "Mute" function is active;
- c. 7" indoor station (item TS-SMART7xx): LCD power on with special icon indicating that the "Mute" function is active;
- d. 10" indoor station (item TS-SMART10xx): LCD power on with special icon indicating that the "Mute" function is active;

8.8 Configuration of external IP cameras

The TS-SMART7xx and TS-SMART10xx touch screens allow the viewing of any IP cameras (with compatible communication protocol), connected to the same data network via Wi-Fi or wired network.

The maximum number of cameras that can be associated is 64.

- **Camera list:** list of cameras previously associated with the device. Press a camera icon to open the page displaying the images transmitted by that camera. To close the page, press the red button. Press the two arrow button to move from one camera to the next. The opened page will be automatically closed after 120 seconds.
- **Add camera:** button used to add new cameras to the device. The parameters on the page allow the following functions:
 - Camera name:** used to assign an identifier to the camera;
 - Camera RSTP address:** RSTP string for displaying camera images; the RSTP string must be verified on the camera itself and is in no way dependent on AVE products;
 - Associated devices:** by activating this parameter, it is possible to associate the camera with an outdoor video intercom station; in this way, when receiving a call from an outdoor station, an additional camera can also be displayed by pressing the "Arrow" button;
 - Add:** button used to confirm the operation;
 - Import profile from microSD:** used to import a camera profile from a file stored on an SD card (not supplied) inserted into the slot at the back of the device.
- **Edit Camera:** used to edit the parameters of a previously configured camera. Select the parameter to be edited, make the change and press the "Save" button.

Note ⁽¹⁾: we recommend that you check the compatibility of the camera with the technical support department or the AVE sales network.

It is possible to connect IP cameras to the "data network" via cable using addresses in the following slots:

- 10.0.8.001 - 254
- 10.0.0.101 - 254

8.8.1 View from TS-SMART7xx and TS-SMART10xx:

The TS-SMART7xx and TS-SMART10xx touch screens can display any IP camera (with compatible communication protocol) connected to the same data network.

To view a previously configured camera on the system:

1. Press the "Surveillance" button on the Home page;
2. Press the "View IP Camera" button;
3. Press the icon of the camera you want to view;
4. Repeat the operation with any other cameras.

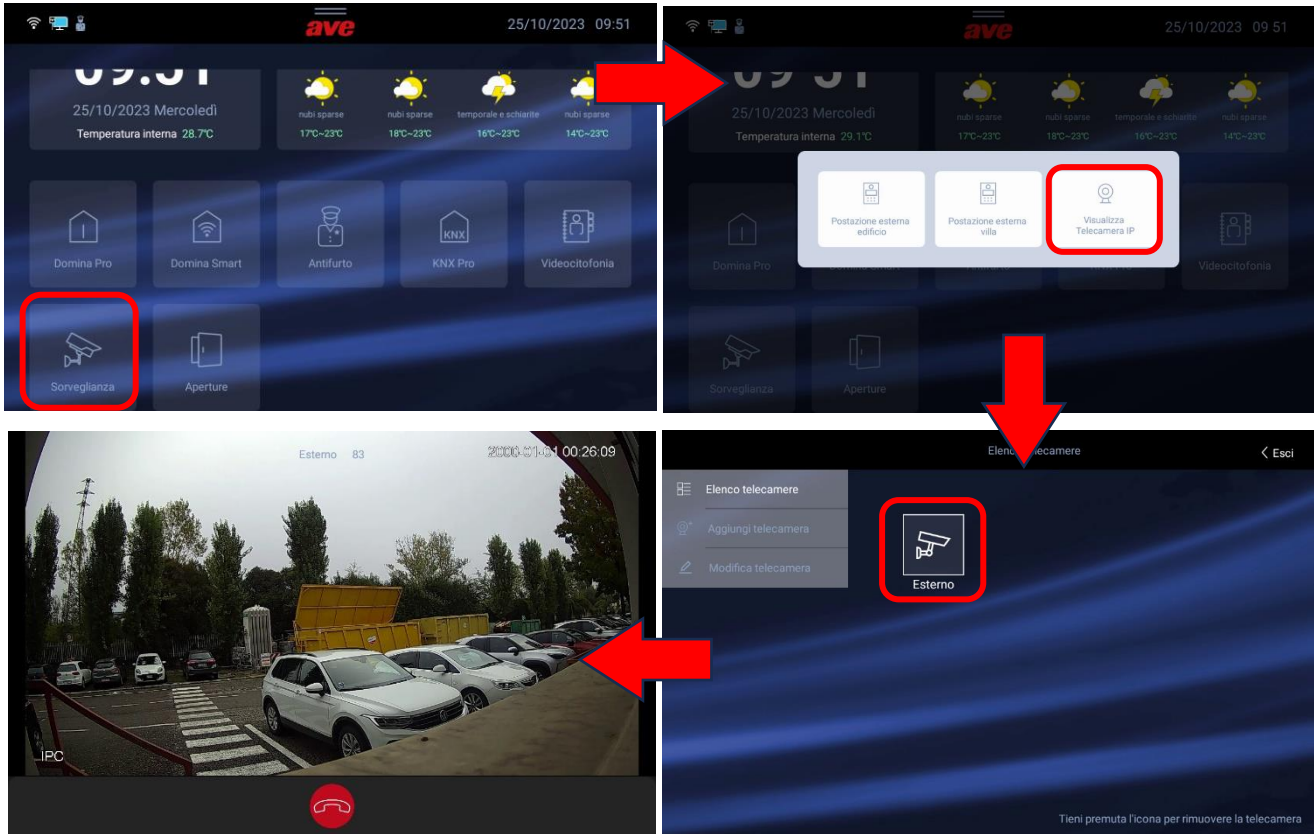

8.9 Replacing name tags

The outdoor stations (item VIIP-PE1, VIIP-PE2, VIIP-PE4, VIIP-PEAUX4 and VIIP-PEAUX) are equipped with name tags placed next to the respective call button. The tag can be replaced by removing the front cover of the devices.

To perform this operation:

- a. Unscrew the central screw on the underside of the DEVICES (the other two screws do not need to be removed);
- b. Pull the bottom side of the cover towards you until it disengages from the outdoor station

Attach any labels, taking care to ensure that the thickness of the labels does not interfere with the correct closure of the protective cover.

Note₁:

Do not dismantle or cut the silicone protection behind the call buttons.

Note₂:

The name tags are backlit using low power white light LEDs: ensure that the installed name tags allow light to pass through for backlighting.

8.10 Restoring the default settings in outdoor stations

Outdoor stations (items VIIP-PE1, VIIP-PE2, VIIP-PE4, VIIP-PE7T) can be reset to default settings by performing simple operations.

It is possible to reset devices either from the device keypad or from the V44 CONFIG configuration software.

The factory data reset operation must take place within the first minute of power-up.

VIIP-PE1, VIIP-PE2, VIIP-PE4

Switch off the power supply to the outdoor station, switch it on again with the door opener input (DOOR) closed to GND and press the front call button for 3 seconds.

After a long "beep", the default settings will be restored: the IP address of the device will be reset and all registered cards will be cancelled.

Resetting the parameters using the V44 CONFIG software:

- Launch the software, select the network on which the devices are installed and browse for them;
- Select the VIIP-PE_{xx} outdoor station from the device list;
- Press the "Restore default settings" button and confirm the operation.

VIIP-PE7T

Resetting the parameters using the keypad:

- Access the configuration menu and then the Information menu;
- Press the "Default settings" button and confirm the operation.

Resetting the parameters using the V44 CONFIG software:

- Launch the software, select the network on which the devices are installed and browse for them;
- Select the VIIP-PE7T outdoor station from the device list;
- Press the "Restore default settings" button and confirm the operation.

9. SYSTEM ACTIVATION

9.1 Connecting devices

The correct procedure for connecting and activating the system is given below:

1. Wire a data cable to connect the outdoor and indoor stations with a connector switch ⁽¹⁾.
2. The devices can be powered via a 48VDC PoE switch or a switching power supply with +24VDC output voltage ⁽²⁾.
3. Power up the devices and wait for their initialisation;
4. Assign a unique address ⁽³⁾ to each indoor station by accessing the configuration parameter as described in the chapter on indoor stations. The device's unique address can be configured using the **AVE V44 CONFIG** management/programming software, available from www.ave.it

Example:

Building 1 - Apartment 1 - Indoor station 1

Building 1 - Apartment 2 - Indoor station 1

Building 1 - Apartment 3 - Indoor station 1

5. If the outdoor station is the mod. VIIP-PE7T, configure it for use with name list/numeric keypad and for all other system requirements.

Note ⁽¹⁾: the connection between the outdoor stations and the indoor stations can only be made via a wired LAN. The Wi-Fi data network (available on the TS-SMARTxx) is only used to connect the indoor stations to a router to manage call answering via an App or to connect to home automation and anti-intrusion alarm systems.

Note ⁽²⁾: never connect both types of power supply at the same time to avoid failure of the power supply sections of the devices.

Note ⁽³⁾: the assignment of two identical addresses leads to system faults with an error message being displayed.

9.2 Interfacing with home automation and anti-intrusion alarm systems

The TS-SMART7xx and TS-SMART10xx indoor monitors can be interfaced with AVE home automation and anti-intrusion alarm systems.

Interfacing with the home automation system and the SMART system is possible via a monitor with integrated web server (e.g. item 53AB-WBS, item TS01).

From the indoor video intercom station it will be possible to manage home automation functions (e.g. lights, roller shutters, scenarios, temperature control, etc.).

Interfacing with the AF927 anti-intrusion alarm control units is direct and requires no additional elements.

To activate the connection between the systems, it is necessary to access the TS-SMART settings page and then the "Smart Home" menu; in the latter, it is possible to enter the IP address of the web server module and/or the anti-intrusion alarm control unit to open the connection with them (check that the system interfacing settings in the programming of these devices are active, if not, activate them).

The interface addresses in the monitor are already configured to ensure correct and error-free communication between the systems:

HOME AUTOMATION: 192.168.1.10

ANTI-INTRUSION: 192.168.1.11

If the parameters are not the same as those configured in your devices, simply tap on the "Current Address" field and change them.

If there is an "IP video intercom system" in the system, it will not be possible to access the "Configure IP-LAN address" parameter, as this is reserved for the system's self-configuration and cannot be changed. Interfacing with home automation and anti-intrusion alarm systems is only possible via a Wi-Fi network.

9.3 "Main device" parameter

The "Main Device" parameter configures a device for communicating with the home automation monitors and the anti-intrusion control unit.

In a system with multiple indoor monitors installed, only one of them can be the "Main Device": activating multiple units with the "Main Device" function will cause an error to occur and communication between the systems to become unstable.

10. CONFIGURING THE AVE VIDEO V44 APP

The V44 SMART system is equipped with the **AVE VIDEO V44 APP**, which allows remote interaction with the system.

The operations that can be performed remotely are:

- Answering a call;
- Releasing the electro-locks;
- Activating the outdoor station camera

The application is available for iPhone (requires iOS 13 or higher) and Android (requires Android 10 or higher) and can be downloaded from their respective online stores.

NOTE:

If the user is using a smartwatch (e.g. Apple Watch) connected to their device, the incoming call alert will not emit any sound, but an alert will appear on the smartwatch itself inviting them to open the App from their mobile phone: this is not a malfunction of the system, but the standard way of using mobile devices (e.g. Apple).

From the Apple website:

Dove vengono visualizzate le notifiche

Le notifiche vengono visualizzate sull'Apple Watch o sull'iPhone, ma non su entrambi i dispositivi.



Se l'iPhone è sbloccato, ricevi le notifiche sull'iPhone anziché sull'Apple Watch.



Se l'iPhone è bloccato o in stato di stop, ricevi le notifiche sull'Apple Watch, a meno che l'Apple Watch non sia bloccato.

10.1 Preliminary steps for user registration

After downloading the App, user registration is required.

To do this, proceed as follows:

1. Launch the App;
2. Press the "Register" button;
3. Scroll down the page and accept the Terms and Conditions of Use;
4. Enter your e-mail;
5. Press the "Request Code" button;
6. Check your inbox and open the e-mail sent by the system;
7. Get the registration code number and enter it in the appropriate field in the App;

8. Press Next
9. Enter the password (at least 8 characters);
10. Confirm the password by re-entering it in the appropriate field;
11. Complete registration by pressing the "Register" button;
12. To log out, go to Account/Settings/Logout menu;
13. Close the APP;
14. Launch the APP again and log in using the username and password you created earlier.

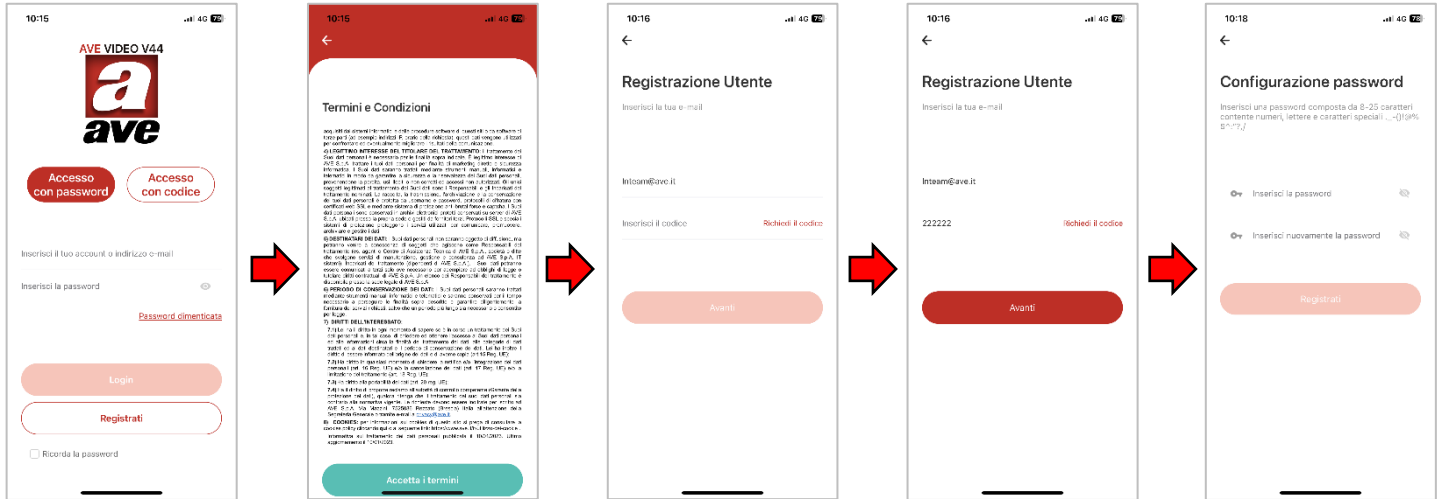

10.2 Associating devices with the App

The devices that can be associated with the AVE VIDEO V44 App are the 7" and 10" Wi-Fi touch screens (items TS-SMART7xx and TS-SMART10xx). The other devices in the IP system are not suitable for remote control.

Perform the following steps to associate a device with the App:

1. Connect the touch screen to a Wi-Fi network with Internet access;
2. Press the "Settings" button on the touch screen;
3. Access the "Cloud Intercom" menu;
4. Press the "Associate" button
5. Access the AVE VIDEO V44 APP;
6. Press the "Add Device" button or the box in the top right-hand corner;
7. Scan the QR code displayed on the touch screen and wait for the device to appear in the App;
8. Select the device and press "Add";
9. Press the "Switch to device list page" button and select the device you have just added;
10. Press the button with the 3 horizontal bars to access the device parameters where you can change the name displayed by the App;
11. Activate the "Show on home page" parameter to allow the device to be displayed on the home page;
12. Exit the menu and press the home button

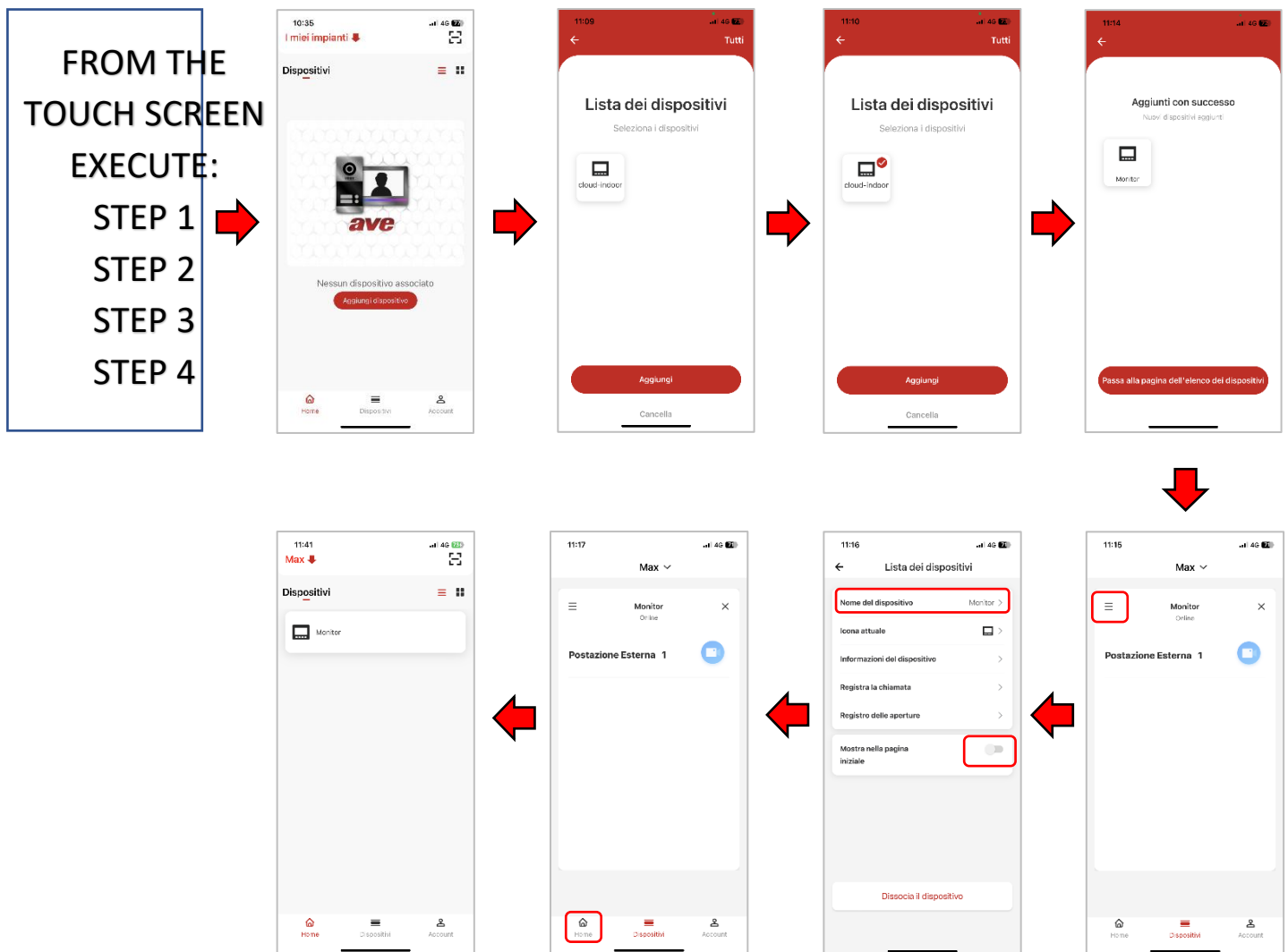

10.3 Deleting Apps associated with the indoor station

To delete an APP from an indoor video intercom station, proceed as follows:

1. Connect the touch screen to a Wi-Fi network with Internet access;
2. Press the "Settings" button on the touch screen;
3. Access the "Cloud Intercom/Associated Users" menu;
4. Press the "Delete APP User" button;
5. Confirm the operation.

The association between the APP and the device is automatically cancelled.

10.4 Deleting devices in the App

To delete a device from the APP, proceed as follows:

1. Access the APP and enter the "Devices" menu;
2. Select the device to be deleted;
3. Press the button with the 3 horizontal bars to access the parameters of the device;
4. Press the "Dissociate device" button;
5. Confirm the operation.

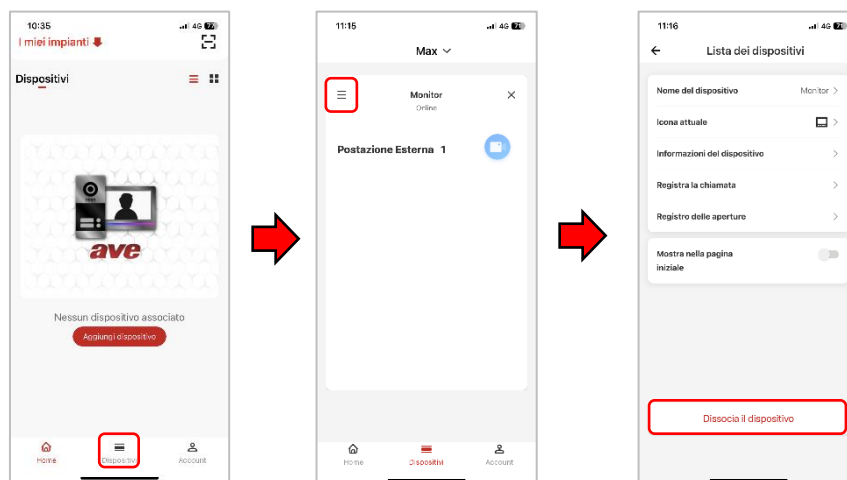

10.5 Inviting new users to your system (system sharing)

To share your system with other users, proceed as follows:

Download the AVE VIDEO V44 App on the mobile phone of the person you are inviting and carry out the registration procedure.

Then launch the AVE VIDEO V44 APP.

INVITATION PROCEDURE FROM THE APP OF THE OWNER OF THE SYSTEM

- Access the Account menu;
- Press "System Management";
- Select the system to be shared with another user;
- Press "User Management";
- Press the "Invite Users" button;
- The system offers two different types of invitation: via QR code or via code;
- If you choose to invite via the QR code, frame the code from the phone of the person you are inviting;
- If you choose to invite via a code, communicate or send the code to the person you are inviting (e.g. via other applications).
- Wait for the other person to accept the invitation from their phone and confirm

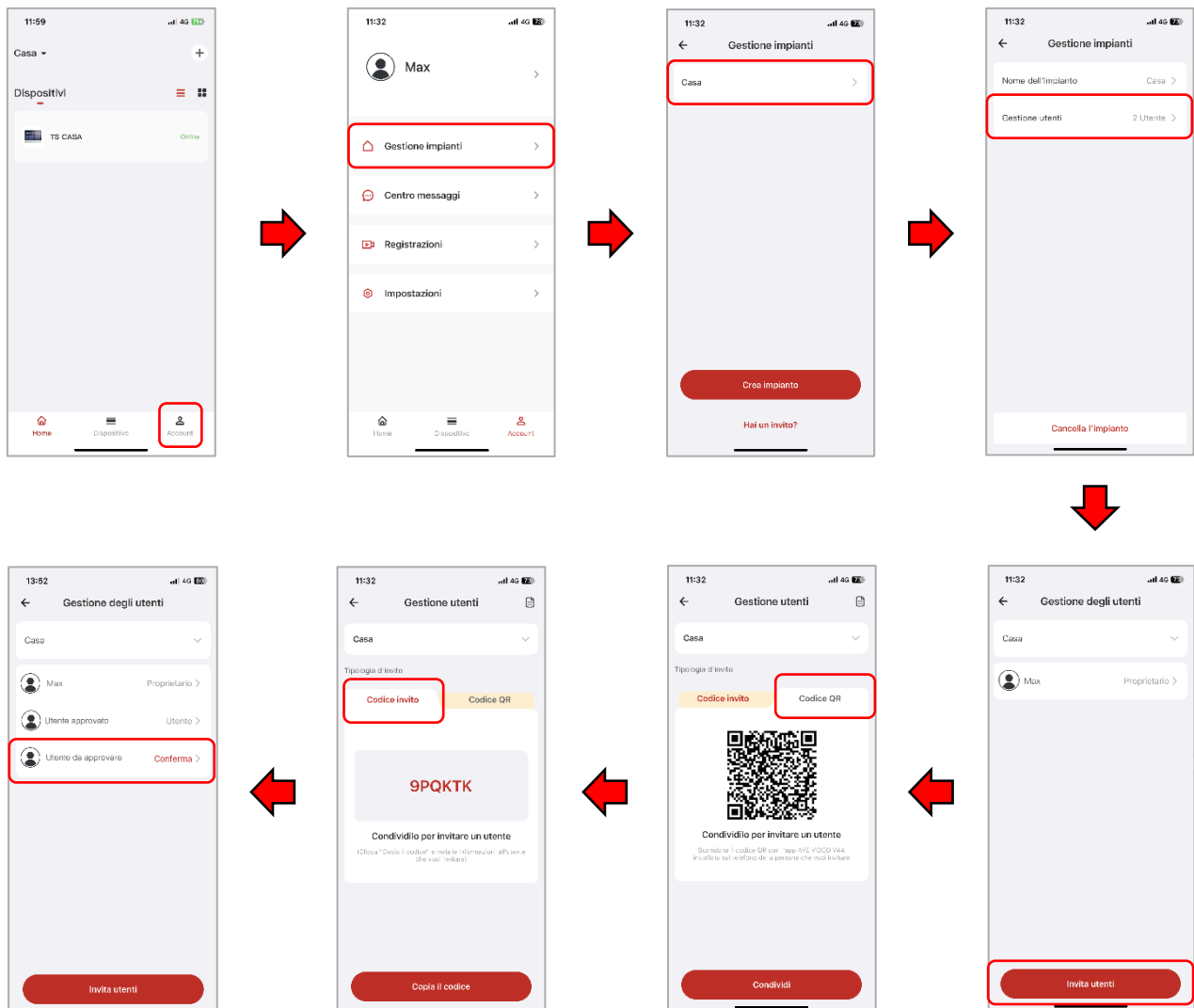

INVITATION PROCEDURE FROM THE APP OF THE OWNER OF THE SYSTEM

To accept an invitation to participate in a system, please proceed as follows:

INVITATION VIA QR CODE

- a) Access the AVE VIDEO V44 APP;
- b) Press "Add Device" and frame the QR code with your phone;

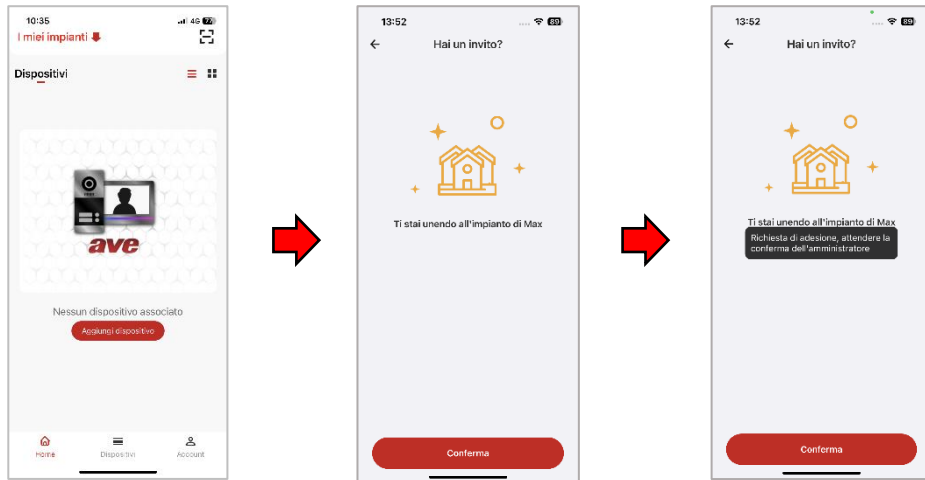

INVITATION VIA AN INVITATION CODE

- a) Access the Account menu;
- b) Press "System Management";
- c) Press "You have an invitation";
- d) Enter the invitation code provided by the system owner;
- e) Press "Confirm"

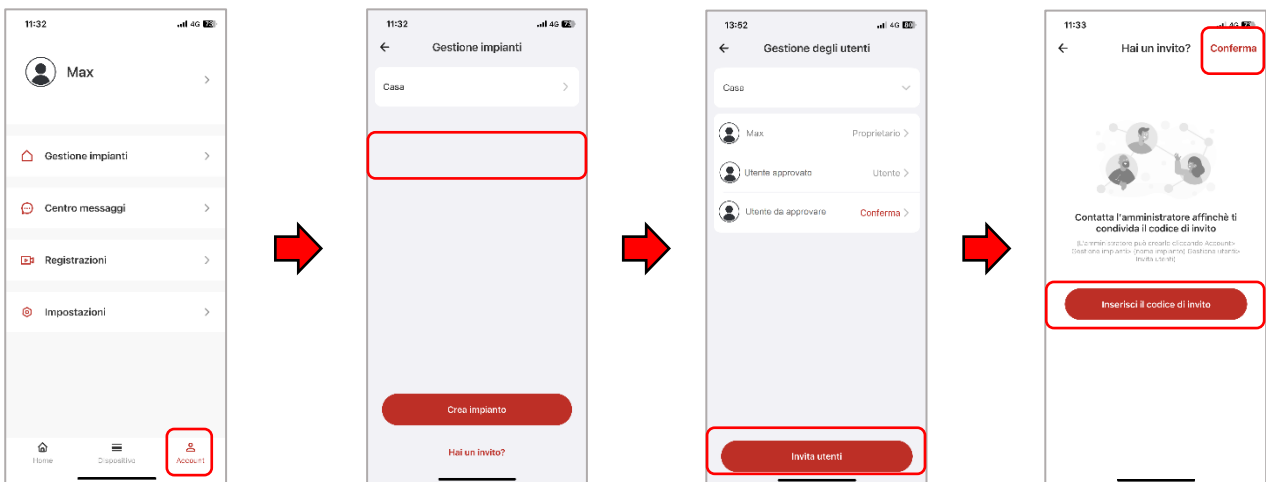

10.6 Deleting an account

To delete an account, please refer to the following procedure:

- a) Access the Account menu;
- b) Press the "Account" button;
- c) Press "Account and Security";
- d) Enter the invitation code provided by the system owner;
- e) Press "Delete Account"
- f) Confirm the deletion of the account.

NOTE:

The actual deletion of an account will take place within 7 days from the date of the request; during this period, it is possible to restore the account by requesting the reactivation code directly in the APP.

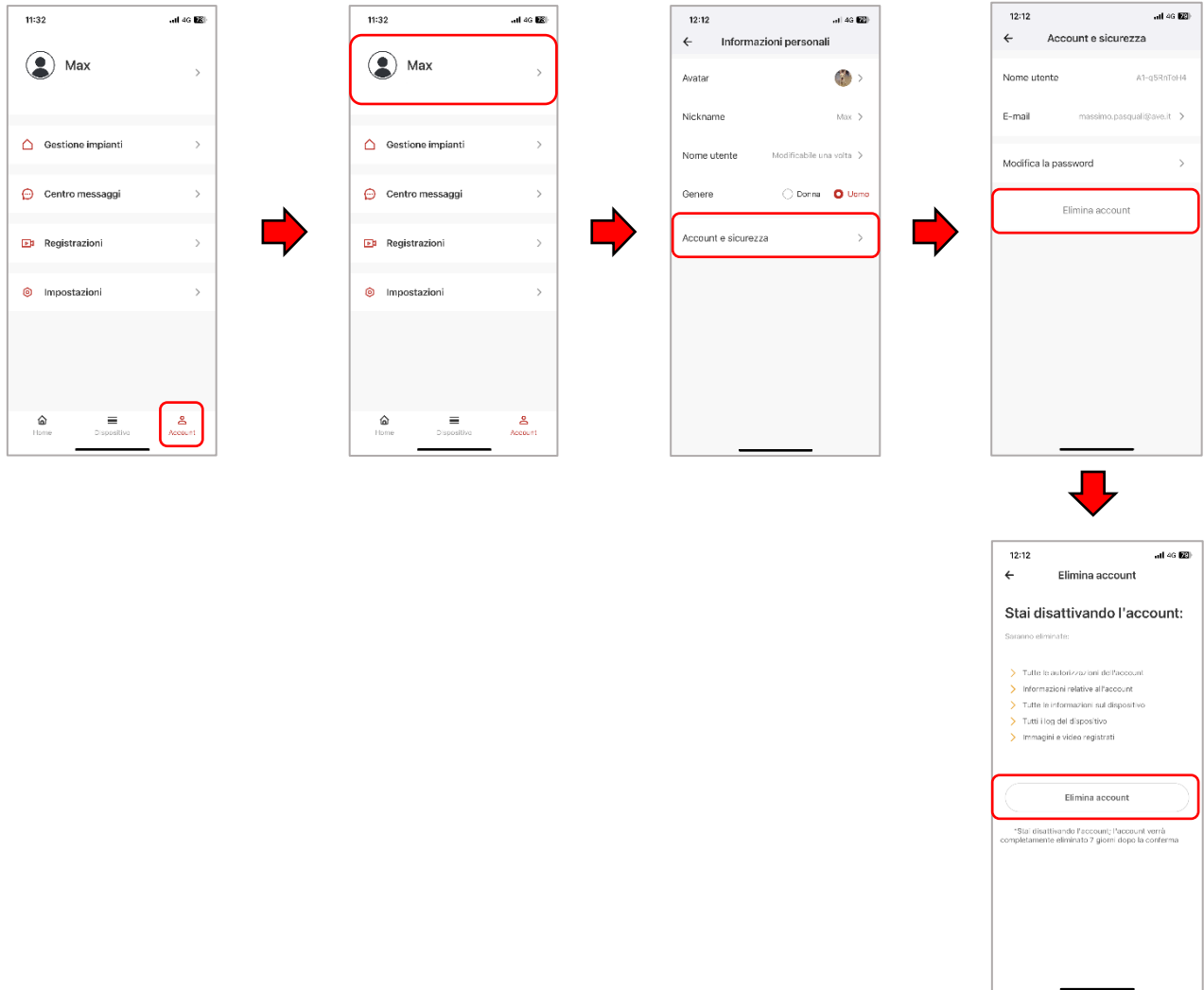

10.7 Answering a call

The AVE VIDEO V44 APP can only accept a call from an outdoor station if the indoor station is a Wi-Fi monitor with a routing function to it.

The call is forwarded to the APP at the same time as it is received at the indoor station.

Answering a call from the APP ends the call on the indoor video intercom stations and other APPs connected to the system.

ATTENTION:

when a call is answered from an indoor station or a mobile device, another connected APP may continue to ring for a few seconds while the system finishes processing the call. It is not possible to answer the same call from more than one device; if you try to answer a call after it has been answered by another user, the call is automatically ended.

When receiving a call, the AVE VIDEO V44 APP allows:

- Answering an incoming call: press the green "Accept" button to answer a call;
- Rejecting an incoming call: press the red "Reject" button to reject a call.

ATTENTION:

- if a call is rejected by a user, automatically all APPs connected to the device will reject the incoming call;
- Muting an incoming call: press the white "Mute" button to mute a call.

ATTENTION:

when an incoming call is muted by a user, the operation is only performed from the user's phone; all other APPs connected to the device will continue to ring;



After answering a call, it is possible:

- To capture the image from the outdoor station camera, during a call, by pressing the "Screenshot" button;
- To record a short video by pressing the "Record" button;
- To activate the system openings (two on board the outdoor station plus any optional additional openings):
 - 1) Unlock: power relay opening (usually associated with a pedestrian gate);
 - 2) Unlock 2: dry contact relay opening (usually associated with a driveway gate);
 - 3) Unlock 3: dry contact relay opening (optional relay not supplied with the device);
- Press the "Hang up" button to end the communication with the outdoor station.
- At the bottom of the page, it is always possible to display the seconds remaining until the end of the call.
- Press the arrow in the top left corner to close the page and return to the device list page.



From the APP it is possible to call up an outdoor station and perform certain operations on it:

- Monitoring the camera at the outdoor station: during monitoring, the microphone of the mobile phone is switched off; to activate the microphone and start a conversation with the outdoor, press the "Speak" button.
- Capturing the image from the outdoor station camera during a call by pressing the "Screenshot" button;
- Recording a short video by pressing the "Record" button;
- To activate the system openings (two on board the outdoor station plus any optional additional openings):
 - 1) Unlock: power relay opening (usually associated with a pedestrian gate);
 - 2) Unlock 2: dry contact relay opening (usually associated with a driveway gate);
 - 3) Unlock 3: dry contact relay opening (optional relay not supplied with the device);
- Press the "Hang up" button to end the communication with the outdoor station.
- At the bottom of the page, it is always possible to display the seconds remaining until the end of the call.
- Press the arrow in the top left corner to close the page and return to the device list page.

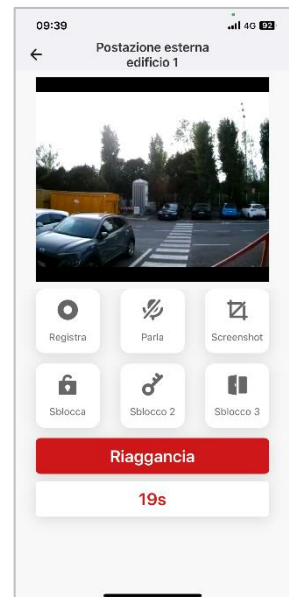

11. V44 CONFIG CONFIGURATION SOFTWARE

The AVE V44 SMART video intercom system is equipped with a configuration software called V44 CONFIG, by means of which various operations can be carried out.

The software is available at www.ave.it.

Via this software, it is possible to:

- Update the software version of the outdoor stations;
- Update the software version of the indoor stations;
- Change the unlocking times of the dry contact relay;
- Change the volume of the external ringtone;
- Change the unique ID of indoor stations;
- Import/export the list of block of flats;
- Export the list of cards associated with the system;
- Change the addressing of the buttons of the outdoor stations mod. "Villa"

The software screen is shown below:

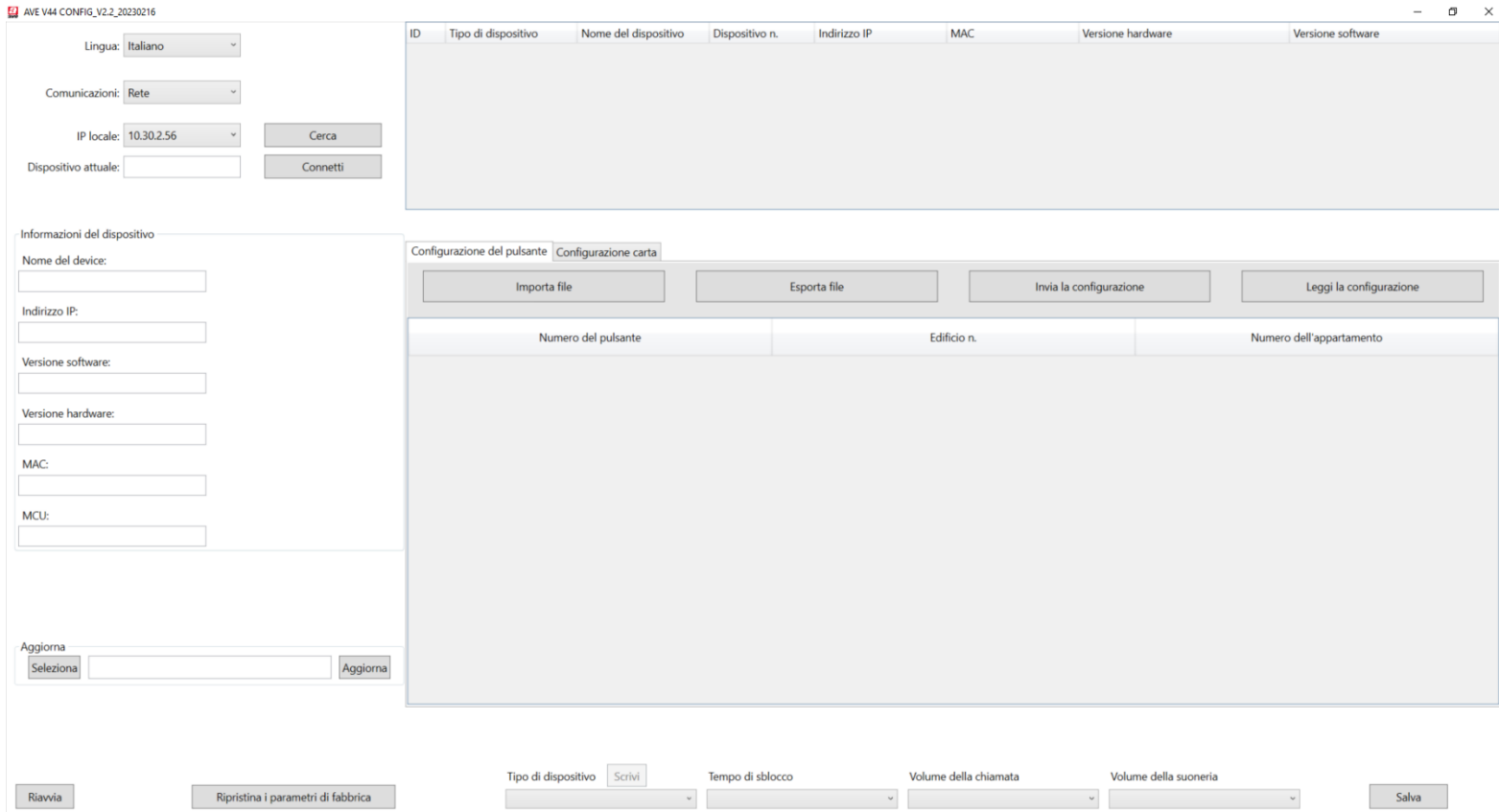

11.1 Procedure for updating/changing the device parameters

The firmware of all the devices in the **V44 SMART** system can be updated depending on the hardware version of the devices installed: newer features may not be compatible and installation on devices with older hardware versions will not be possible.

Go to www.ave.it to check for updates of the AVE V44 CONFIG configuration software.

After the system has been switched on and all the indoor and outdoor stations have been connected to the same data network, connect the PC on which the **V44 Config** configuration software is installed.

Change the IP address of your PC as follows:

IP address: 10.0.0.xx

Subnet mask: 255.0.0.0

CAUTION: Do not assign address 100 to your PC as it is reserved by the system.

10.1.1 Updating the devices

Please refer to the following instructions to update devices:

- 1 Select "Network" in the "Communications" button;
- 2 Select the local IP associated with your PC;
- 3 Press the "Search" button: the table will populate with all devices found in the system ⁽¹⁾;
- 4 Press on the line of the device to be updated;
- 5 Select the file to be updated and press the "Update" button;
- 6 Confirm the operation: the system will updating the device; do not switch off the device and do not interact with it to avoid malfunctioning.
- 7 At the end of the update procedure, it is always advisable to reset the device to its default parameters using the "Restore factory parameters" button in the software (for all types of device) or via the user interface of the indoor stations;
- 8 Once the update operation is complete, it is possible to update another device by repeating the same procedure.

AVE V44 CONFIG_V2.2_20230216

Lingua: Italiano

Comunicazioni: Rete **①**

IP locale: 10.30.2.56 **②** Cerca **③**

Dispositivo attuale: 10.30.2.50 Disconnetti

ID	Tipo di dispositivo	Nome del dispositivo	Dispositivo n.	Indi
1	Postazione interna	TS-SMART10	001-1-2	10.3
2	Postazione interna	TS-SMART10	001-15-1	10.3
3	Postazione interna	TS-SMART10	001-2-1	10.3
4	Postazione interna	TS-SMART7	001-19-1	10.3
5	Postazione interna	TS-SMART7	001-14-1	10.3

④

Nome del device: TS-SMART10 Edificio/villa: Edificio

Indirizzo IP: 10.30.2.50 Edificio: 1 App.to: 2 N.: 1

Versione software: TS-SMART10_V1.1.4_20230206

Versione hardware: Hardware REC1.1 181012

MAC: 1C:87:76:85:EF:C6

MCU: V1.34_20220609

Imposta n. dispositivo

Tipologia	Edificio	App.to	N.
Edificio	1	2	1

⑤

Aggiorna

Seleziona C:\Users\massimo.pasquali\Desktop\VIIP-PE7T_V2.4_20230203.apk Aggiorna

Configurazione dei pulsanti | Configurazione carta

Importa file | Esporta file

Numero del pulsante

Messaggio

Sei sicuro di voler aggiornare il dispositivo?

TS-SMART10_V1.1.4_20230206
---->
VIIP-PE7T_V2.4_20230203.apk

⑥ OK Annulla

Note 1: If no devices are displayed, repeat the procedure, checking that all devices are switched on including the PoE switch;

10.1.2 Changing the closing times of "Unlock 2" relay

The outdoor stations are equipped with 2 relays for unlocking 2 electro-locks.

The first unlock can directly control high-power 12V electro-locks (up to 13 W) without the need for external auxiliary sources. With respect to GND, a short high-energy 24 V voltage pulse is applied to the terminal when the NO contact closes.

The second unlock is managed by a dry contact relay. The closing time of this relay can be set from 1 to 30 seconds.

Use the "Unlock Time" parameter to set the closing time of the "Unlock 2" contact.

To change the contact closing time:

- 1 Connect to the desired outdoor station;
- 2 Change the contact closing time;
- 3 Press the "Write" button to make the change effective.

10.1.3 Changing the call and ringtone volume

The volume of the audio and sound emitted by the outdoor stations while waiting for a call to be answered can be adjusted.

To change the two parameters:

- 4 Connect to the desired outdoor station;
- 5 Change the "Call volume" parameter (low, medium, high);
- 6 Change the "Ringtone volume" parameter (low, medium, high);
- 7 Press the "Save" button.



10.1.4 Creating a list of names

The VIIP-PE7T outdoor station allows a call to be made to an indoor station using either the name list or the numeric keypad: the choice between the two modes is made in the device's configuration menus.

A name list can be created directly from the device configuration menu (password-protected access) or via the V44CONFIG software.

To perform the operation, proceed as follows:

1. Connect to the VIIP-PE7T outdoor station using the V44CONFIG configuration software;
2. Press the "Export file" button and save it to the desktop of your PC (the program exports a .csv file that can be managed by Microsoft Excel®);
3. Open the file you have just saved and populate it by entering:
 - Flat number:
 - Call to a Building indoor station = 001-0001
 - Call to a Villa indoor station = 001
 - Desired labels in the compartments next to the desired flat;
4. Save the compiled file and close it;
5. From the V44 CONFIG software, import the file you have just saved;
6. Press the "Send configuration" button to send to the desired VIIP-PE7T outdoor station.

The VIIP-PE7T allows the insertion of an image on the left side of the displayed name. For this purpose, the images must be uploaded into the same folder where the previously downloaded .csv file with the names was saved.

Images must be in .png or .jpg format, with a maximum size of less than 400KB and a name length of less than 16 characters.

In the "Image" column of the previously downloaded .csv file, enter the name of the image to be associated including the extension (e.g. photo1.jpg).

From the V44CONFIG software, import the saved file and send the configuration to the VIIP-PE7T outdoor station.

ATTENTION: the icons shown in the device are round in shape; images will be re-sized to be displayed in that shape.

Welcome->Videocitofonia IP									
ID	Edificio n.	Piano n.	Appartamento n.	Indirizzo fisico(*)	Nome utente 1(*)	Immagine	Indirizzo logico	Carta n.(*)	Password utente(*)
1	CAMPI RISERVATI AD UTILIZZI FUTURI			001-0001	Utente 1	1.jpg	CAMPO RISERVATO AD UTILIZZI FUTURI		CAMPO RISERVATO AD UTILIZZI FUTURI
3				001-0002	Utente 2	2.jpg			
4				001-0003	Utente 3	3.jpg			
5				001-0004	Utente 4	4.jpg			
6				001-0005	Utente 5	5.jpg			

AVE V44 CONFIG_V2.6_20231114

Cerca

Lingua: Italiano

Comunicazioni: Rete

IP locale: 10.0.55

Dispositivo attuale: 10.0.64.0

Cerca Disconnetti

ID	Tipo di dispositivo	Nome del dispositivo	Dispositivo n.	Indirizzo IP	MAC	Versione hardware	Versione software
1	Postazione interna	TS-SMART10	001-2-1	10.0.65.2	1C87:76:85:EF:47	Hardware REC1.1 181012	TS-SMART10_V1.1.6_20231108
2	Postazione interna	TS-SMART7	001-3-1	10.0.65.3	1C87:76:85:EF:7D	Hardware REC1.1 181012	TS-SMART7_V1.1.6_20231108
3	Postazione esterna edifici	VIIP-PE7T	001-5	10.0.64.32	1C87:76:85:FB:46	Hardware V1.0 20180403	VIIP-PE7T_V2.7.2_20231127
4	Postazione esterna edifici	VIIP-PE7T	001-1	10.0.64.0	1C87:76:85:FB:49	Hardware V1.0 20180403	VIIP-PE7T_V2.7.2_20231127

Informazioni del dispositivo

Nome del device: VIIP-PE7T Indirizzo IP: 10.0.64.0

Versione software: VIIP-PE7T_V2.7.2_20231127 Versione hardware: Hardware V1.0 20180403

MAC: 1C87:76:85:FB:49 MCU: V1.24_20220927

Edificio/villa: Edificio 1 Numero 1





Imposta n. dispositivo: Tipo di dispositivo Postazione esterna edificio Edificio 1 Numero 1

Aggiorna: Selezione Aggiorna

Riavvia Ripristina i parametri di fabbrica

Configurazione carta Rel? associati

Importa file Esporta file Invia la configurazione Leggi la configurazione

ID	Edificio n.	Piano n.	Appartamento n.	Indirizzo fisico	Nome utente 1	Immagine	Indirizzo logico	Carta n.	Password utente
1				001-0001	Utente 1				
2				001-0002	Utente 2				
3				001-0003	Utente 3				
4				001-0004	Utente 4				
5				001-0005	Utente 5				



12. WIRING DIAGRAMS

12.1 Overview of the IP system

Below is an overview of all the products in the IP video intercom range.

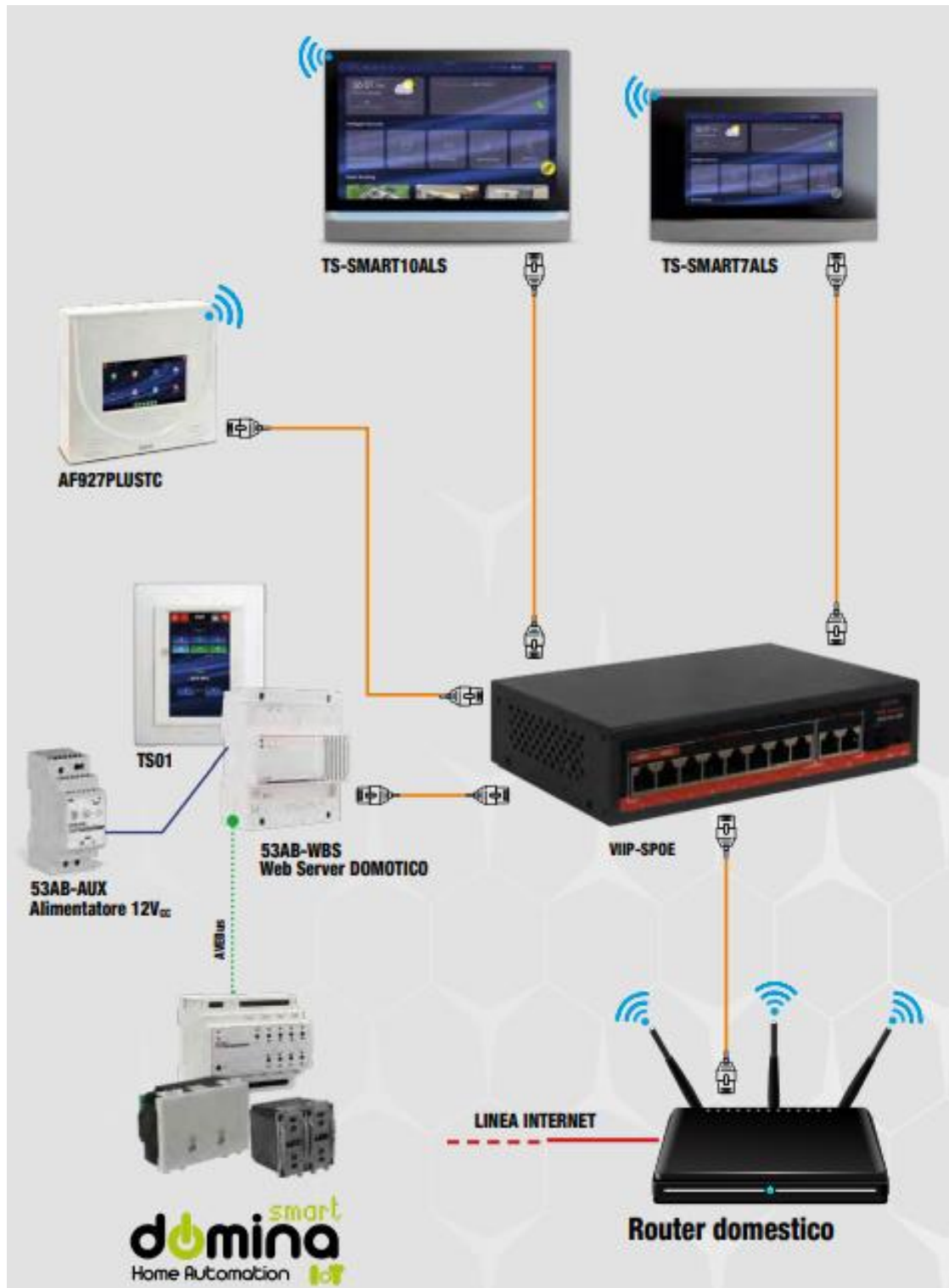

NOTES:

For the duration and conditions of the warranty for each product, please refer to www.ave.it and to the latest sales catalogue. The products must be marketed in their original packaging, otherwise the retailer and/or installer is obliged to apply and forward to the user the instructions accompanying the product and/or posted on www.ave.it and in the latest sales catalogue. AVE items are products for installation purposes. They must be installed by qualified personnel in accordance with current regulations and usage, observing AVE S.p.A.'s storage, operation and installation instructions. Compliance with the general terms and conditions of sale, notes, general warnings, warranty warnings, claims and technical warnings for the installer posted on www.ave.it and in the latest sales catalogue is also required. **WARNINGS:** Items must be handled with care and stored in their original packaging in a dry location, protected from the elements and at a temperature suitable for storage as indicated in the product manual. If items are not in their original packaging, the dealer and/or installer is obliged to attach and forward the accompanying operating instructions to the user. Storage of items for periods greater than 5 years is not recommended. After opening the packaging, ensure that the item is intact. Installation must be carried out by qualified personnel in accordance with the requirements of the current standard for electrical installations.

The information in this manual may contain technical inaccuracies, omissions or typographical errors. The information contained herein is subject to change or update without notice. AVE S.p.A. also reserves the right to make changes/improvements to the products and/or programs described in this manual at any time and without notice.

BEFORE INSTALLING SYSTEMS AND AUTOMATIONS, IT IS STRONGLY RECOMMENDED THAT YOU ATTEND A TRAINING COURSE, IN ADDITION TO READING THE INSTRUCTIONS CAREFULLY.