

Serie Life - Allumia

Life - Allumia series

Assiali
Axial

Dimensione del modulo

Module dimension

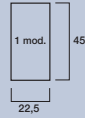

Serie Allumia colore RAL 9007 finitura LUCIDA

color RAL 9007
POLISHED finish



Comandi assiali

con i comandi assiali di nuova generazione é possibile attivare il carico premendo qualsiasi punto della superficie dei tasti. Una volta premuti ritornano in posizione restando sempre perfettamente allineati alla placca di finitura.

Axial switches

by using the new generation axial controls it is possible to activate the load by pressing any point on the surface of the keys. Once pressed they return to position, always remaining perfectly aligned with the front plate.

Superficie del comando completamente chiusa per ridurre al minimo l'ingresso della polvere
Fully enclosed control surface to minimize dust ingress

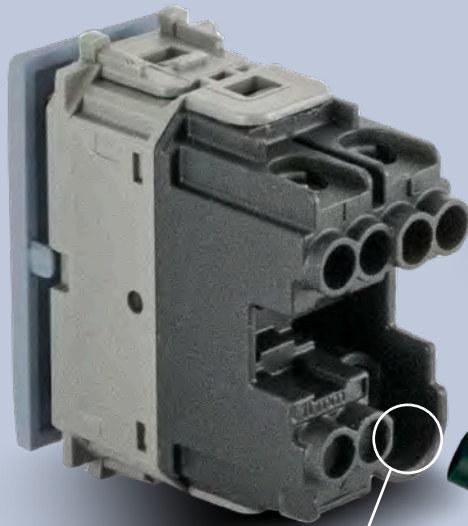

Inserimento lampadina di segnalazione
Lamp insertion

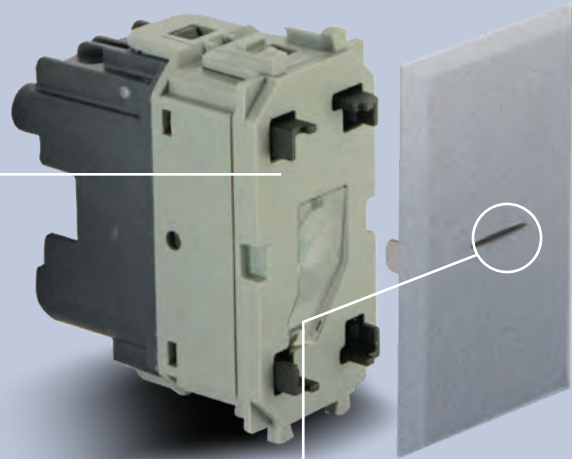

Consigliato l'utilizzo di lampada a led colore blu (cod. 0230LDB)
It is recommended the use of blue colour led lamp (code 0230LDB)

Caratteristiche Tecniche Technical Features



Per la disponibilità contattare la rete commerciale
For availability please contact sales dept.



Disponibilità fino ad esaurimento scorte
Available until stock out



Prodotto per scatola rettangolare inglese
Product for British standard rectangular box











Prodotto per Export
For Export only









Corpo Comando Assiali 250V~ Axial switches 250V~

			Descrizione Description	Info	€	□	□
			□ 445001STAS Corpo interruttore assiale per serie Tekla, Whitek e Allumia, 1P 10AX illuminabile-1 mod. <i>Axial switch body for Tekla, Whitek and Allumia series, 1P 10AX lightable - 1 mod.</i>		8,95	10	100
445001STAS	445002STAS	445005STAS	□ 445002STAS Corpo deviatore assiale per serie Tekla, Whitek e Allumia, 1P 10AX illuminabile-1 mod. <i>Axial two way switch body for Tekla, Whitek and Allumia series, 1P 10AX lightable - 1 mod.</i>		10,54	10	100
			□ 445005STAS Corpo pulsante assiale per serie Tekla, Whitek e Allumia, 1P 10A illuminabile-1 mod. <i>Axial pushbutton body for Tekla, Whitek and Allumia series, 1P 10A lightable - 1 mod.</i>		10,57	10	100
Nota: forniti senza lampada di segnalazione Note: supplied without lamp							

Comandi Assiali Axial switches

Allumia	Descrizione Description	Info	€	□	□
	■ 443001AS Interruttore assiale con gemma, 1P 10AX illuminabile - 1 mod. <i>Axial switch with gem, 1P 10AX lightable - 1 mod.</i>		12,15	10	100
443001AS 443010AS	■ 443010AS Interruttore bipolare assiale con gemma, 2P 10AX illuminabile - 1 mod. <i>Axial bipolar switch with gem, 2P 10AX lightable - 1 mod.</i>		29,76	10	100
	■ 443002AS Deviatore assiale con gemma, 1P 10AX illuminabile - 1 mod. <i>Axial two way switch with gem, 1P 10AX lightable - 1 mod.</i>		14,53	10	100
443002AS 443004AS	■ 443004AS Invertitore assiale con gemma, 1P 10AX illuminabile - 1 mod.1 <i>Axial intermediate switch with gem, 1P 10AX lightable - 1 mod.</i>		29,76	10	100
	■ 443005AS Pulsante assiale con gemma, 1P 10A illuminabile - 1 mod. <i>Axial push-button with gem, 1P 10A illuminated - 1 mod.</i>		14,75	10	100
443005AS	Nota: forniti senza lampada di segnalazione Note: supplied without lamp				

Tasti intercambiabili assiali Interchangeable rockers axial

Allumia	Descrizione Description	Info	€	□	□
	■ 443TAS Tasto intercambiabile con gemma per comandi assiali - 1 mod. <i>Interchangeable rocker with gem for axial controls - 1 mod.</i>		3,88	5	5
443TAS	■ 443TKPAS Tasto intercambiabile con simbolo chiave per comandi assiali - 1 mod. <i>Interchangeable rocker with key symbol for axial controls - 1 mod.</i>		4,68	5	5
	■ 443TLPAS Tasto intercambiabile con simbolo lampada per comandi assiali - 1 mod. <i>Interchangeable rocker with lamp symbol for axial controls - 1 mod.</i>		4,68	5	5
443TKPAS	■ 443TSPAS Tasto intercambiabile con simbolo suoneria per comandi assiali - 1 mod. <i>Interchangeable rocker with ringtone symbol for axial commands - 1 mod.</i>		4,68	5	5
					
443TLPAS					
					
443TSPAS					

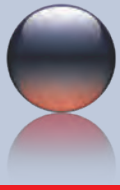

Serie Life - Allumia

Life - Allumia series



Caratteristiche Tecniche Technical Features

Serie Life
colore RAL 9017
finitura LUCIDA

color RAL 9017
POLISHED finish



Serie Allumia
colore RAL 9007
finitura LUCIDA

color RAL 9007
POLISHED finish



Cacciaviti per comandi e prese di corrente *Screwdrivers for control devices and socket outlets*

Indicazioni per l'utilizzo di cacciaviti appropriati:

- tutti i prodotti elettromeccanici (interruttori, prese, supporti) sono dotati di viti con testa a croce che possono essere fissate con avvitatori automatici e manuali intaglio a croce PHILLIPS dimensione 2 e cacciavite a lama con larghezza max 5 mm e spessore max 0,8 mm.
- il momento torcente massimo non deve superare 1,8 Nm.

Information on use of suitable screwdrivers:

- all electromechanical products (switches, sockets and supports) are equipped with crosshead screws which can be fixed by automatic PHILLIPS screwdrivers size 2 and manual crosshead screwdrivers with max width 5 mm and max thickness 0,8 mm.
- maximum torque must not exceed 1.8 Nm

Illuminazione Comandi *Controls lighting*

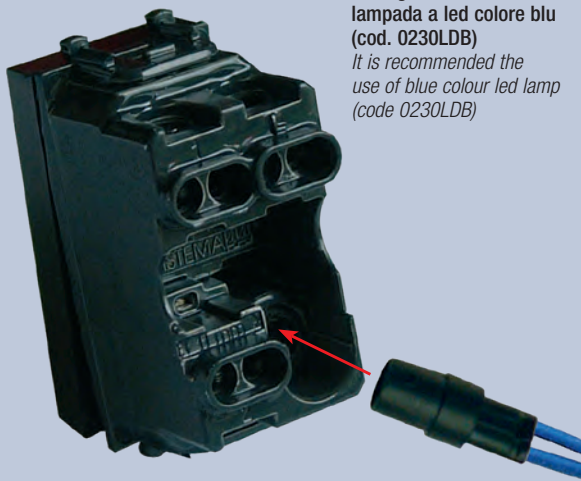

Inserimento lampadina di segnalazione
Lamp insertion

Consigliato l'utilizzo di lampada a led colore blu (cod. 0230LDB)
It is recommended the use of blue colour led lamp (code 0230LDB)

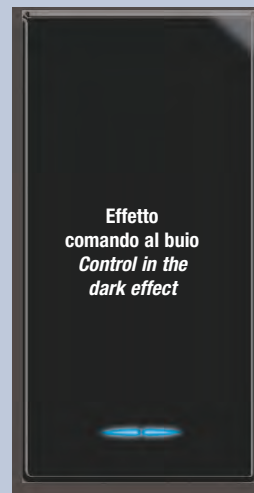

Effetto comando al buio
Control in the dark effect

Comando illuminato: con Life/Allumia anche i comandi standard sono illuminabili
Lighted control: with Life/Allumia even the standard controls are lightable



Per la disponibilità contattare la rete commerciale
For availability please contact sales dept.



Disponibilità fino ad esaurimento scorte
Available until stock out



Prodotto per scatola rettangolare inglese
Product for British standard rectangular box



Prodotto per Export
For Export only

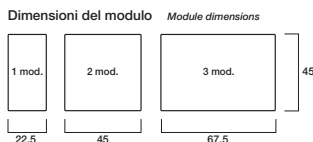

Interruttori 250V~ One way switches 250V~

Life 44	Allumia	Descrizione Description	Info	€	□	□
		■ 442001ST Corpo interruttore 1P 16AX - Serie Life - illuminabile da completare con tasto 1 o 2 moduli - 1 modulo <i>1P 16AX one way lightable switch mechanism - Life Serie - to be completed with 1 or 2 module rocker - 1 module</i>		■ 8,50	10	100
		■ 445001ST Corpo interruttore 1P 16AX - Serie Allumia - illuminabile da completare con tasto 1 o 2 moduli - 1 modulo <i>1P 16AX one way lightable switch mechanism - Allumia Serie - to be completed with 1 or 2 module rocker - 1 module</i>		■ 8,13	10	100
		■ 442001 ■ 443001 Interruttore 1P 16AX illuminabile - tasto intercambiabile - 1 modulo <i>1P 16AX one way lightable switch - interchangeable rocker - 1 module</i>		■ 8,91 ■ 7,55	10	100
		■ 443001/20A Interruttore 1P 20AX illuminabile - tasto intercambiabile - 1 modulo <i>1P 20AX one way lightable switch - interchangeable rocker - 1 module</i>		■ 11,07	10	100
		■ 442001/2 ■ 443001/2 Interruttore 1P 16AX a tasto largo illuminabile - tasto intercambiabile - 2 moduli <i>1P 16AX one way lightable large switch - interchangeable rocker - 2 modules</i>		■ 12,32 ■ 11,11	5	50
		■ 442010 ■ 443010 Interruttore 2P 16AX illuminabile - tasto intercambiabile - 1 modulo <i>2P 16AX one way lightable switch - interchangeable rocker - 1 module</i>		■ 18,89 ■ 17,54	10	100
		■ 443010SL Interruttore 2P 16AX con gemma ad alta visibilità - tasto intercambiabile - 1 modulo <i>2P 16AX one way lightable switch with gem - interchangeable rocker - 1 module</i>		■ 18,97	10	100
		■ 442010/2 Interruttore 2P 16AX a tasto largo illuminabile - tasto intercambiabile - 2 moduli <i>2P 16AX one way lightable large switch - interchangeable rocker - 2 modules</i>		■ 20,85	1	1
		■ 442010RS/20A Interruttore 2P 20AX illuminabile - rosso - 1 modulo <i>2P 20AX one way lightable switch - red - 1 module</i>		■ 16,15	1	10

Nota: forniti senza lampada di segnalazione
Note: supplied without lamp

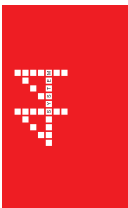



Serie Life - Allumia

Life - Allumia series



Deviatori 250V~
Two way switches 250V~

130

Life 44

Allumia

Descrizione *Description*

Info

€

□

□



442002ST



445002ST

■ 442002ST

Corpo deviatore 1P 16AX - Serie Life - illuminabile da completare con tasto 1 o 2 moduli - 1 modulo

1P 16AX two way lightable switch mechanism - Life Serie - to be completed with 1 or 2 module rocker - 1 module

■ 10,30

10 100

■ 445002ST

Corpo deviatore 1P 16AX - Serie Allumia - illuminabile da completare con tasto 1 o 2 moduli - 1 modulo

1P 16AX two way lightable switch mechanism - Allumia Serie - to be completed with 1 or 2 module rocker - 1 module



■ 9,92

10 100



442002



443002
443002/20A

■ 442002

Deviatore 1P 16AX illuminabile - tasto intercambiabile - 1 modulo

1P 16AX two way lightable switch - interchangeable rocker - 1 module

■ 10,90

10 100

■ 443002

■ 9,26

■ 443002/20A

Deviatore 1P 20AX illuminabile - tasto intercambiabile - 1 modulo

1P 20AX two way lightable switch - interchangeable rocker - 1 module

■ 13,48

10 100



442002/2



443002/2

■ 442002/2

Deviatore 1P 16AX a tasto largo illuminabile - tasto intercambiabile - 2 moduli

1P 16AX two way lightable large switch - interchangeable rocker - 2 modules

■ 14,83

5 50

■ 443002/2

■ 13,11



Per la disponibilità contattare la rete commerciale
For availability please contact sales dept.



Disponibilità fino ad esaurimento scorte
Available until stock out







Prodotto per scatola rettangolare inglese
Product for British standard rectangular box



Prodotto per Export
For Export only

Invertitori 250V~ Intermediate switches 250V~









Life 44	Allumia	Descrizione Description	Info	€	□	□
		■ 442004ST Corpo invertitore 1P 16AX illuminabile da completare con tasto 1 o 2 moduli - 1 modulo <i>1P 16AX lightable intermediate switch mechanism to be completed with 1 or 2 module rocker - 1 module</i>		■ 20,57	1	1
442004ST		■ 442004 ■ 443004 Invertitore 1P 16AX illuminabile - tasto intercambiabile - 1 modulo <i>1P 16AX lightable intermediate switch - interchangeable rocker - 1 module</i>		■ 21,80 ■ 20,41	10	100
		■ 443004/2 Invertitore 1P 16AX a tasto largo illuminabile - tasto intercambiabile - 2 moduli <i>1P 16AX lightable large intermediate switch - interchangeable rocker - 2 modules</i>		■ 22,71	5	50
442004	443004					
						
	443004/2					

Nota: forniti senza lampada di segnalazione
Note: supplied without lamp



Sistema 45

Tasti intercambiabili per Interruttori, Deviatori e Invertitori Interchangeable rockers for one way switch, two way switch and intermediate switch

Life 44	Allumia	Descrizione Description	Info	€	□	□
		■ 442T ■ 443T Tasto intercambiabile generico illuminabile - 1 modulo <i>Interchangeable smooth lightable rocker - 1 module</i>		■ 3,49 ■ 3,19	14	14
442T	443T	■ 442T/2 ■ 443T/2 Tasto intercambiabile generico illuminabile - 2 moduli <i>Interchangeable smooth lightable rocker - 2 modules</i>		■ 5,12 ■ 4,63	2	2
		■ 442TGP ■ 443TGP Tasto intercambiabile con gemma illuminabile - diffusore visibile anche di giorno - 1 modulo <i>Interchangeable rocker with lightable lens - diffuser visible even in daylight - 1 module</i>		■ 4,60 ■ 4,22	14	14
442T/2	443T/2	■ 443TGP/2 Tasto intercambiabile con gemma illuminabile - diffusore visibile anche di giorno - 2 moduli <i>Interchangeable rocker with lightable lens - diffuser visible even in daylight 2 modules</i>		■ 5,97	2	2
		■ 443TSL Tasto intercambiabile con gemma ad alta visibilità - da utilizzare con corpo comando 44500..ST - 1 modulo <i>Interchangeable button with high visibility gem - to be used with 44500..ST - 1 module</i>		■ 4,32	5	5
442TGP	443TGP					
						
	443TGP/2					
						
	443TSL					



Serie Life - Allumia

Life - Allumia series

Pulsanti 250V~
Push-buttons 250V~



132

Life 44

Allumia

Descrizione *Description*

Info

€

□

□



442005ST



445005ST

■ 442005ST

Corpo pulsante 1P NA 10A illuminabile - Serie Life - da completare con tasto 1 o 2 moduli - 1 modulo

1P NO 10A lightable push-button mechanism - Life Serie - to be completed with 1 or 2 module rocker - 1 module

■ 8,98

10 100

■ 445005ST

Corpo pulsante 1P NA 10A illuminabile - Serie Allumia - da completare con tasto 1 o 2 moduli - 1 modulo

1P NO 10A lightable push-button mechanism - Allumia Serie - to be completed with 1 or 2 module rocker - 1 module



■ 8,50

10 100



442005
442005/2P



443005

■ 442005

■ 443005

Pulsante 1P NA 10A illuminabile - tasto intercambiabile - 1 modulo

1P NO 10A lightable push-button - interchangeable rocker - 1 module

■ 9,55

10 100

■ 8,36

■ 443005SL

Pulsante 1P NA 10A con gemma ad alta visibilità - 1 modulo

1P NO 10A high visibility push-button with gem - 1 module



■ 11,55

10 100



443005SL

■ 443005/2

Pulsante 1P NA 10A a tasto largo illuminabile - tasto intercambiabile - 2 moduli

1P NO 10A large lightable push-button - interchangeable rocker - 2 modules

■ 11,24

5 50

■ 442005/2P

Pulsante 2P NA 10A illuminabile - tasto intercambiabile - 1 modulo

2P NO 10A lightable push-button - interchangeable rocker - 1 module

■ 13,23

1 10



443005/2

■ 442025

■ 443025

Pulsante 1P NA+NC 10A illuminabile - tasto intercambiabile - 1 modulo

1P NO+NC 10A lightable push-button - interchangeable rocker - 1 module

■ 15,00

10 10

■ 13,27

■ 442050

■ 443050

Pulsante 1P NA 10A 250V con spia di segnalazione illuminabile - diffusore trasparente - fornito con etichette di personalizzazione - 1 modulo

1P NO 10A 250V - lightable push-button - transparent diffuser - supplied with customized labels - 1 module

■ 21,24

1 10

■ 19,55



442025



443025

■ 442056

■ 443056

Doppio pulsante 1P NA + 1P NA 10A - illuminabile (solo versione Life) - senza interblocco: è consentita la chiusura contemporanea dei 2 circuiti - 1 modulo

1P NO + 1P NO 10A double push-button - lightable (only Life version) - without interblock: the simultaneous closure of the 2 circuits is allowed - 1 module

■ 24,06

1 10

■ 21,90

■ 442056F

■ 443056F

Doppio pulsante 1P NA + 1P NA 10A con frecce direzionali - illuminabile (solo versione Life) - senza interblocco: è consentita la chiusura contemporanea dei 2 circuiti - 1 modulo

1P NO + 1P NO 10A double push-button with arrows - lightable (only Life version) - without interblock: the simultaneous closure of the 2 circuits is allowed - 1 module

■ 24,06

1 10

■ 21,90



442050



443050



442056



443056



442056F



443056F

Note: ✓ gli articoli illuminabili sono forniti senza lampada di segnalazione

✓ 44..056 e 44..056F consentendo la chiusura contemporanea di due circuiti non sono adatti all'inversione di marcia di motori (es. tapparelle, ecc.)

Note: ✓ lightable articles are supplied without lamp

✓ since 44..056 and 44..056F allow the contemporaneous closure of two circuits, they are not suitable for motor reversing (ex. rolling shutter, etc.)



Per la disponibilità contattare la rete commerciale
For availability please contact sales dept.



Disponibilità fino ad esaurimento scorte
Available until stock out







Prodotto per scatola rettangolare inglese
Product for British standard rectangular box



Prodotto per Export
For Export only

Pulsanti 250V~
Push buttons 250V~

Life 44	Allumia	Descrizione Description	Info	€	□	□
	442017	<p>■ 442017 ■ 443017</p> <p>Pulsante 1P NA+NC 10A a tirante - cordone in materiale isolante 1,5 m - 1 modulo 1P NO+NC 10A cord push-button - insulating material cord 1,5 m - 1 module</p>		<p>■ 22,37 1 10</p> <p>■ 21,77</p>		
	443017					
		<p>■ 442005TP/2</p> <p>Pulsante 1P NA 10A con targhetta portanome retroilluminata - illuminazione a mezzo lampada con attacco E10 10x28 mm tipo T10 1,5W max ad incandescenza o led - fornito con lampada a led 230V~ - fornito con cartoncino portanome personalizzabile - 2 moduli 1P NO 10A push-button with lightable name tag - illumination by incandescent or led lamp E10 10x28 mm T10 1,5W max type - supplied with customizable name tag card - supplied with 230V~ led lamp - 2 modules</p>		<p>■ 28,92 1 6</p>		
	442005TP/2					
		<p>■ 442025RS/2</p> <p>Pulsante di emergenza 1P NA+NC 10A a tasto largo illuminabile - rosso - 2 moduli 1P NO+NC 10A large emergency lightable push-button - red - 2 modules</p>		<p>■ 16,13 1 6</p>		
	442025RS/2					

Note: ✓ gli articoli illuminabili sono forniti senza lampada di segnalazione
Note: ✓ lightable articles are supplied without lamp



Sistema 45

Comandi con Tasti Intercambiabili Controls with Interchangeable Rockers Pulsante con Targhetta Portanome Push button with name tag



Rimozione tasto
Rocker removal

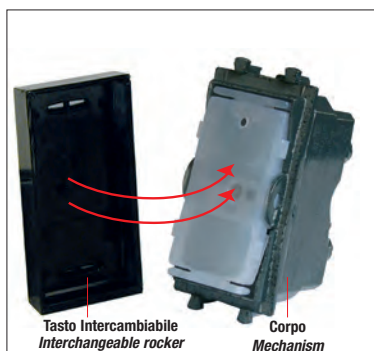

Montaggio tasto
Rocker assembly

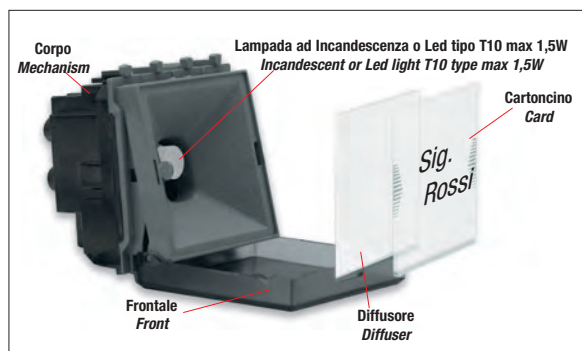

Montaggio lampada e cartoncino
Lamp and card assembly

Le dimensioni, salvo diversamente specificato, sono in mm
Dimensions, except where otherwise specified, are in mm

□ Imballo Minimo pcs
Min. Packaging pcs

□ Imballo Standard pcs
Std. Packaging pcs

















Serie Life - Allumia

Life - Allumia series



Tasti intercambiabili per pulsanti
Interchangeable rockers for push-buttons

134

Life 44	Allumia	Descrizione Description	Info	€	□	□
 442T	 443T	<p>■ 442T ■ 443T</p> <p>Tasto intercambiabile generico illuminabile - 1 modulo <i>Interchangeable smooth lightable rocker - 1 module</i></p>		■ 3,49 ■ 3,19	14	14
 442T/2	 443T/2	<p>■ 442T/2 ■ 443T/2</p> <p>Tasto intercambiabile generico illuminabile - 2 moduli <i>Interchangeable smooth lightable rocker - 2 modules</i></p>		■ 5,12 ■ 4,63	2	2
		<p>■ 443TSL</p> <p>Tasto intercambiabile con gemma ad alta visibilità - da utilizzare con corpo comando 44500..ST - 1 modulo <i>Interchangeable button with high visibility gem - to be used with 44500..ST - 1 module</i></p>		■ 4,32	5	5
		<p>■ 442TGP ■ 443TGP</p> <p>Tasto intercambiabile con gemma illuminabile - diffusore visibile anche di giorno - 1 modulo <i>Interchangeable rocker with lightable lens - diffuser visible even in daylight 1 module</i></p>		■ 4,60 ■ 4,22	14	14
	 443TSL	<p>■ 443TGP/2</p> <p>Tasto intercambiabile con gemma illuminabile - diffusore visibile anche di giorno - 2 moduli <i>Interchangeable rocker with lightable lens - diffuser visible even in daylight 2 modules</i></p>		■ 5,97	2	2
 442TGP	 443TGP	<p>■ 442TKP ■ 443TKP</p> <p>Tasto intercambiabile con simbolo CHIAVE illuminabile - 1 modulo <i>Interchangeable rocker with lightable KEY symbol - 1 module</i></p>		■ 4,37 ■ 3,92	14	14
		<p>■ 443TKP/2</p> <p>Tasto intercambiabile con simbolo CHIAVE illuminabile - 2 moduli <i>Interchangeable rocker with lightable KEY symbol - 2 modules</i></p>		■ 5,80	2	2
	 443TGP/2	<p>■ 442TLP ■ 443TLP</p> <p>Tasto intercambiabile con simbolo LAMPADA illuminabile - 1 modulo <i>Interchangeable rocker with lightable LAMP symbol - 1 module</i></p>		■ 4,37 ■ 3,92	14	14
 442TKP	 443TKP					
	 443TKP/2					
 442TLP	 443TLP					



Per la disponibilità contattare la rete commerciale
For availability please contact sales dept.



Disponibilità fino ad esaurimento scorte
Available until stock out







Prodotto per scatola rettangolare inglese
Product for British standard rectangular box



Prodotto per Export
For Export only







Tasti intercambiabili per pulsanti

Interchangeable rockers for push-buttons

Life 44	Allumia	Descrizione Description	Info	€	□	□
		■ 443TLP/2 Tasto intercambiabile con simbolo LAMPADA illuminabile - 2 moduli <i>Interchangeable rocker with lightable LAMP symbol - 2 modules</i>		■ 5,86	2	2
		■ 442TSP ■ 443TSP Tasto intercambiabile con simbolo SUONERIA illuminabile - 1 modulo <i>Interchangeable rocker with lightable BELL symbol - 1 module</i>		■ 4,37 ■ 3,92	14	14
442TSP		■ 443TSP/2 Tasto intercambiabile con simbolo SUONERIA illuminabile - 2 moduli <i>Interchangeable rocker with lightable BELL symbol - 2 modules</i>		■ 5,86	2	2
		■ 442TSP Tasto intercambiabile con simbolo LUCE SCALE illuminabile - 1 modulo <i>Interchangeable rocker with lightable STAIR LIGHT symbol - 1 module</i>		■ 4,37	14	14
442TRESP		■ 442TRESP ■ 443TRESP Tasto intercambiabile con scritta RESET illuminabile - 1 modulo <i>Interchangeable rocker with lightable RESET symbol - 1 module</i>		■ 4,37 ■ 3,92	14	14



Commutatori 250V~ Rolling blind switches 250V~

Life 44	Allumia	Descrizione Description	Info	€	□	□
		■ 442051 ■ 443051 Commutatore 1P 10AX (3 morsetti) - 3 posizioni (OFF centrale) - con interblocco: non è consentita la chiusura contemporanea dei 2 circuiti - 2 tasti - con frecce direzionali - 1 modulo <i>1P 10AX rolling blind switch (3 terminals) - 3 positions (central OFF) - with interlock: the simultaneous closure of the 2 circuits is not allowed - 2 rockers - with arrows - 1 module</i>		■ 29,52 ■ 28,48	1	10
442051 442052	443051 443052	■ 442052 ■ 443052 Commutatore 2P 10AX (6 morsetti) - 3 posizioni (OFF centrale) - con interblocco: non è consentita la chiusura contemporanea dei 2 circuiti - 2 tasti - con frecce direzionali - 1 modulo <i>2P 10AX rolling blind switch (6 terminals) - 3 positions (central OFF) - with interlock: the simultaneous closure of the 2 circuits is not allowed - 2 rockers - with arrows - 1 module</i>		■ 32,39 ■ 31,20	1	10
		■ 442053 ■ 443053 Commutatore 1P 10A (3 morsetti) a pulsante - 3 posizioni (OFF centrale) - con interblocco: non è consentita la chiusura contemporanea dei 2 circuiti - 2 tasti - con frecce direzionali - 1 modulo <i>1P 10A rolling blind push-button (3 terminals) - 3 positions (central OFF) - with interlock: the simultaneous closure of the 2 circuits is not allowed - 2 rockers - with arrows - 1 module</i>		■ 30,22 ■ 27,47	1	10
442053 442054	443053 443054	■ 442054 ■ 443054 Commutatore 2P 10A (6 morsetti) a pulsante - 3 posizioni (OFF centrale) - con interblocco: non è consentita la chiusura contemporanea dei 2 circuiti - 2 tasti - con frecce direzionali - 1 modulo <i>2P 10A rolling blind push-button (6 terminals) - 3 positions (central OFF) - with interlock: the simultaneous closure of the 2 circuits is not allowed - 2 rockers - with arrows - 1 module</i>		■ 33,32 ■ 29,74	1	10
		■ 442051BS ■ 443051BS Commutatore a bascula 1P 10AX 3 posizioni (OFF centrale) con frecce direzionali - 1 modulo <i>1P 10AX rolling blind switch - 3 positions (central OFF) with arrows - 1 module</i>		■ 22,71 ■ 21,49	1	10
442051BS 442053BS	443051BS 443053BS	■ 442053BS ■ 443053BS Commutatore pulsante a bascula 1P 10A 3 posizioni con frecce direzionali - 1 modulo <i>1P 10A rolling blind push-button 3 positions (central OFF) with arrows - 1 module</i>		■ 26,52 ■ 24,23	1	10

Nota: 44..052 e 44..054 utilizzabili per inversione di marcia, es. motori abbaini
Note: 44...52 and 440054 usable for reversing, e.g. dormer motors

Le dimensioni, salvo diversamente specificato, sono in mm
 Dimensions, except where otherwise specified, are in mm

Imballo Minimo pcs
 Min. Packaging pcs

Imballo Standard pcs
 Std. Packaging pcs



Serie Life - Allumia

Life - Allumia series

Comandi 230V~ "a sfioramento"
"touch" controls 230V~



136

Life 44

Allumia

Descrizione Description

Info

€

□

□



443001S

■ 443001S

■ 77,47

1

10

Interruttore elettronico con uscita a relè 1P NA 6A 230V~ - comando mediante sfioro superficie frontale o da più punti con normali pulsanti NA - funzionamento bistabile - led di individuazione al buio a basso consumo - memorizzazione dello stato del relè d'uscita in caso di interruzione di rete - alimentazione 230V~ - 1 modulo
Electronic touch switch - relay output 1P NO 6A 230V~ - controlled by touching the frontal area or from multiple points with NO buttons - bistable operating mode - low consumption led for identification in the darkness - output relay status memorization in case of blackout - 230V~ power supply - 1 module



443005S

■ 443005S

■ 73,50

1

10

Pulsante elettronico per comando remoto con sensore a sfioramento - comando mediante sfioro superficie frontale - funzionamento monostabile - led di individuazione al buio a basso consumo - alimentazione 230V~ - da abbinare a interruttore elettronico 44..001S, 44..001S/2F, 44..016S dimmer a sfioramento 44..048SU o commutatore a sfioramento 44..051S - 1 modulo
Electronic push button for remote control with touch sensor - controlled by touching the frontal area - monostable operating mode - low consumption led for identification in the darkness - 230V~ power supply - to be combined with electronic switch 44..001S, 44..001S/2F, 44..016S with touch dimmer 44..048SU or touch rolling blind switch 44..051S - 1 module



443016S

■ 443016S

■ 247,74

1

1

Comando elettronico multi-touch con 6 uscite a relè monostabili con contatto in chiusura 1P NA 2A 230V~ libero da potenziale - comando mediante sfioro superficie frontale o da più punti con normali pulsanti NA - funzionamento uscite: monostabili, bistabili o temporizzate, tapparelle (con interblocco funzionale) - n° 6 led frontali di individuazione al buio a basso consumo - memorizzazione dello stato dei relè d'uscita in caso di interruzione di rete - alimentazione 100÷240V~ 50-60 Hz - 3 moduli
Electronic multi-touch control - 6 monostable output-relay 1P NO 2A 230V~ Dry contact - controlled by touching the frontal area or from multiple points with NO push-buttons - operating mode: monostable, bistable or timed, curtains (with interlock) - n. 6 low consumption front led for identification in the darkness - status memory in case of blackout - powered 100÷240 V ~ 50-60 HZ - 3 modules



443051S

■ 443051S

■ 80,86

1

10

Commutatore elettronico con uscita a 2 relè monostabili con contatto in chiusura NA 2A 230V~ - comando mediante sfioro superficie frontale o da più punti con normali pulsanti NA - funzionamento monostabile o temporizzato - led di individuazione al buio a basso consumo - alimentazione 230V~ - 1 modulo
Electronic touch rolling blind switch with 2 monostable relay output, NO contact 2A 230V~ - Controlled by touching the frontal area or from multiple points with NO buttons - monostable or timed operating mode - Low consumption LED for identification in the dark - 230V~ power supply - 1 module



Per la disponibilità contattare la rete commerciale
For availability please contact sales dept.



Disponibilità fino ad esaurimento scorte
Available until stock out



Prodotto per scatola rettangolare inglese
Product for British standard rectangular box



Prodotto per Export
For Export only





Dimmer per regolazione luci Dimmer for lighting control

Life 44	Allumia	Descrizione Description	Info	€	□	□
		<p>■ 442048 ■ 443048 Regolatore di luminosità 230V~ (127V~) 50-60Hz - TRIAC - taglio di fase per lampade ad incandescenza e alogene 100÷500W - regolazione con potenziometro rotativo - led di individuazione al buio - 1 modulo <i>Dimmer 230V~ (127V~) 50-60Hz for resistive loads (incandescent and halogen lamps) 100÷500W (60÷300W) - regulation with rotary potentiometer - led for identification in the dark - 1 module</i></p>		■ 54,34 ■ 51,37	1	6
442048	443048					
		<p>■ 442048D ■ 443048D Regolatore di luminosità 230V~ 50-60Hz - TRIAC - taglio di fase per lampade ad incandescenza e alogene 40÷300W - comando con deviatore incorporato e regolazione con potenziometro rotativo - led di individuazione al buio - profondità ridotta - viti dei morsetti laterali - 1 modulo <i>Dimmer 230V~ 50-60Hz for resistive loads (incandescent and halogen lamps) 40÷300W - control with built-in two-way switch and regulation with rotary potentiometer - led for identification in the dark - reduced depth - side terminal screws - 1 module</i></p>		■ 64,47 ■ 60,96	1	6
442048D	443048D					
		<p>■ 442048U Regolatore di luminosità 230V~ 50-60Hz per carichi resistivi e induttivi (lampade ad incandescenza e alogene, trasformatori ferromagnetici per lampade alogene a bassa tensione) 60÷500W - comando e regolazione con pulsante incorporato o da più punti con normali pulsanti NA - led di individuazione al buio - 1 modulo <i>Dimmer 230V~ 50-60Hz for resistive and inductive loads (incandescent and halogen lamps, ferromagnetic transformers for low voltage halogen lights) 60÷500W control and regulation by built-in push-button or by normal NO buttons from more points - led for identification in the dark - 1 module</i></p>		■ 74,09	1	6
442048U 442048UL	443048UL					
		<p>■ 442048UL ■ 443048UL Regolatore di luminosità 230V~ 50-60 Hz per carichi resistivi e induttivi (lampade ad incandescenza e alogene 3-220W, trasformatori elettronici 20-220W, lampade LED 3-120W, lampade CFL 3-220W - alimentatori elettronici LED a taglio di fase) - comando e regolazione con pulsante incorporato o da più punti con normali pulsanti NA - led di individuazione al buio a basso consumo - memorizzazione dello stato e del livello dell'uscita in caso d'interruzione di rete - 1 modulo <i>230V~ 50-60 Hz dimmer for resistive and inductive loads (3-220W incandescent and halogen lamps, ferromagnetic transformers 20-220VA, LED lamps 3-120W, CFL lamps 3-220W - electronic ballasts for LED with line interruption) - control and regulation by built-in push-buttons or by normal NO buttons from more points - low consumption led for identification in the dark - status and level memory in case of blackout - 1 module</i></p>		■ 110,45 ■ 105,45	1	6
442048AE						
		<p>■ 442048AE Regolatore per alimentatori elettronici ingresso 1÷10V - contatto 4A/250V~ - 1 modulo <i>Dimmer for electronic power units input 1÷10V - contact 4A/250V~ - 1 module</i></p>		■ 93,85	1	6



Sistema 45

Comandi a chiave key commands

Life 44	Allumia	Descrizione Description	Info	€	□	□
		<p>■ 442071 ■ 443071 Interruttore 2P 10AX con chiave - codifica chiave casuale - fornito con 2 chiavi - la chiave esce in entrambe le posizioni - 1 modulo <i>2P 10AX one way switch with key - random key encoding - supplied with 2 keys - the key exits in both positions - 1 module</i></p>		■ 70,29 ■ 67,14	1	10
442071	443071					
		<p>■ 442075 ■ 443075 Pulsante 2P NA 10A con chiave - codifica chiave casuale - fornito con 2 chiavi - la chiave esce solo in posizione di aperto - 1 modulo <i>2P NO 10A push-button with key - random key encoding - supplied with 2 keys - the key exits only in the open position - 1 module</i></p>		■ 70,30 ■ 67,17	1	10
442075	443075					
		<p>Note: ✓ a richiesta gli interruttori a chiave 44..071 possono essere forniti con chiave estraibile solo in posizione di aperto Note: ✓ 44..071 key switches can be supplied with key removable only in the open position upon request</p>				

Le dimensioni, salvo diversamente specificato, sono in mm
Dimensions, except where otherwise specified, are in mm

 Imballo Minimo pcs
Min. Packaging pcs

 Imballo Standard pcs
Std. Packaging pcs



Diagramma di copertura *Covering Diagram*

Vista in pianta *Plan view*



Vista laterale *Side view*

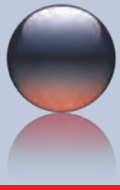
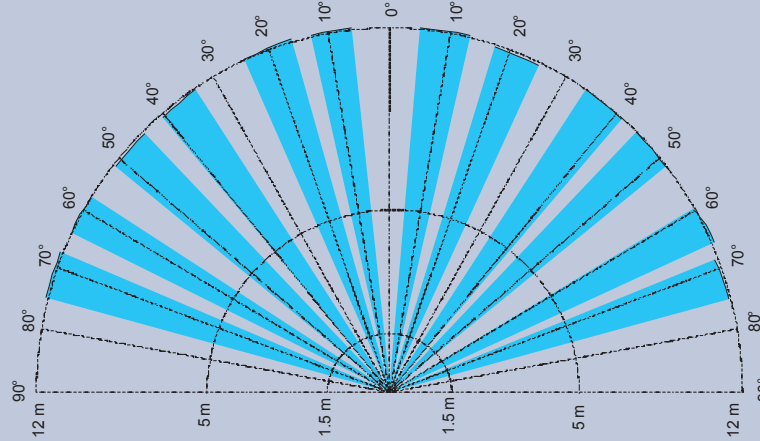
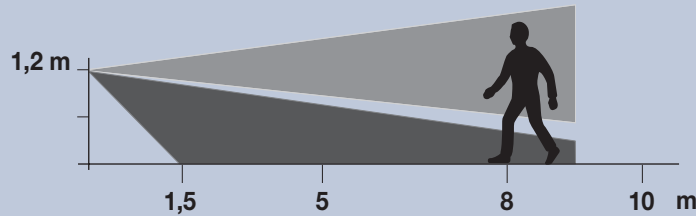

Schemi applicativi *Application Diagrams*

Installazione per comando carico da due o più punti di rivelazione
Installation to control the load from two or more detecting spots

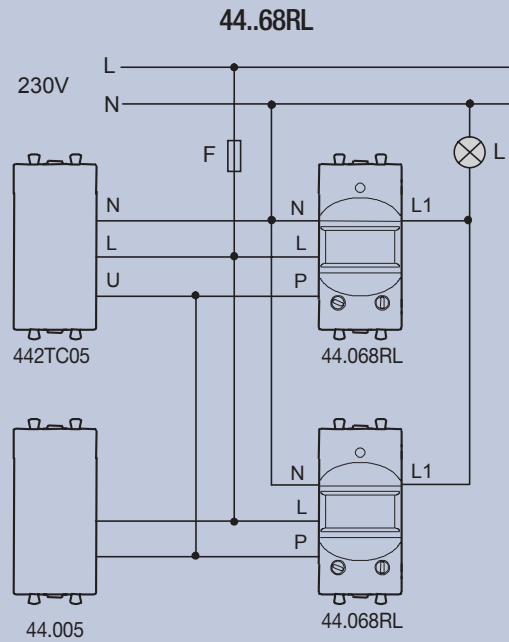

L: carico NA 10A 230V L: load NA 10A 230V F: fusibile tipo T 10 H 250 V F: fuse type T 10 H 250 V

Caratteristiche Tecniche *Technical Features*



Per la disponibilità contattare la rete commerciale
For availability please contact sales dept.



Disponibilità fino ad esaurimento scorte
Available until stock out





Prodotto per scatola rettangolare inglese
Product for British standard rectangular box



Prodotto per Export
For Export only

Rivelatori di movimento Detectors











Life 44	Allumia	Descrizione Description	Info	€	□	□
		<p>■ 442068RL ■ 443068RL</p> <p>LUCE AMICA Rivelatore di movimento a raggi infrarossi per accensione luci - uscita a relè NA 10(4)A 230V~ - alimentazione 110÷230V~ - regolazione frontale del ciclo di temporizzazione da 10 s a 7 min - regolazione frontale della soglia della luminosità ambiente - lente fissa con portata regolabile da 2 m a 12 m e apertura 150° - ingresso per pulsanti di comando remoti - possibilità di impostazione funzionamento: Automatico/Crepuscolare/Forzatura ON/Semiautomatico - 1 modulo</p> <p>LUCE AMICA Infrared motion detector for lighting control - NO 10(4)A 230V~ output relay - 110÷230V~ power supply - Frontal duty cycle time regulation from 10 s to 7 min - Frontal regulation of light sensitivity threshold - fixed lens range from 2 m to 12 m and 150° opening - input for remote controls push buttons - possibility to set operating mode: Automatic/Night/Forced ON/Semi-Automatic - 1 module</p>	Info	151,11 148,56	1	6

139

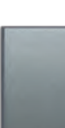

Sistema 45

Copriforo e uscita Blank insert and cable outlet

Life 44	Allumia	Descrizione Description	Info	€	□	□
		<p>■ 442008 ■ 443008</p> <p>Uscita Ø 9 mm con serracavo antitrazione - consente il passaggio di cavi da Ø 4 mm a Ø 8 mm - 1 modulo</p> <p>Cable outlet Ø 9 mm with cable grip - it allows the passage of cables from Ø 4 mm to Ø 8 mm - 1 module</p>	Info	4,72 4,48	10	100
		<p>■ 442013 ■ 443013</p> <p>Tappo copriforo - pretranciatura posteriore centrale per agevolare eventuali fori - 1 modulo</p> <p>Blank insert - central pre-cut in rear side to facilitate any holes - 1 module</p>	Info	2,05 1,95	10	300
		<p>■ 442013R ■ 443013R</p> <p>Tappo copriforo - pretranciatura posteriore centrale per agevolare eventuali fori - 1/2 modulo</p> <p>Blank insert - central pre-cut in rear side to facilitate any holes - 1/2 module</p>	Info	3,41 3,41	12	72
		<p>■ 442013A/2 ■ 443013A/2</p> <p>Tappo copriforo attrezzabile - predisposizione per aggancio a involucro vuoto - 2 moduli</p> <p>Equippable blank insert - preset for clipping it to empty 2 modules base - 2 modules</p>	Info	4,62 4,59	4	24
		<p>■ 443013A/3</p> <p>Tappo copriforo attrezzabile - predisposizione per aggancio a involucro vuoto - 3 moduli</p> <p>Equippable blank insert - preset for clipping it to empty 3 modules base - 3 modules</p>	Info	7,03	2	14
		<p>■ 442S0 ■ 443S0</p> <p>Mostrina sporgente per alloggiamento sonde varie (temperatura, umidità, ecc.) - 1 modulo</p> <p>Prominent blank insert for various probe types (temperature, humidity, etc.) installation - 1 module</p>	Info	7,18 6,87	1	1

Nota: a richiesta potrà essere fornito l'involucro per l'aggancio al tappo copriforo 44..013A/2 e 44..013A/3
Note: the base for the 44..013A/2 and 44..013A/3 blank insert clipping can be supplied upon request

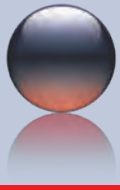

Serie Life - Allumia

Life - Allumia series



Prese di corrente standard italiano 250V~
250V~ Italian standard socket outlets

140

Caratteristiche Tecniche Technical Features

Prese Standard Italiano Italian Standard Socket Outlets

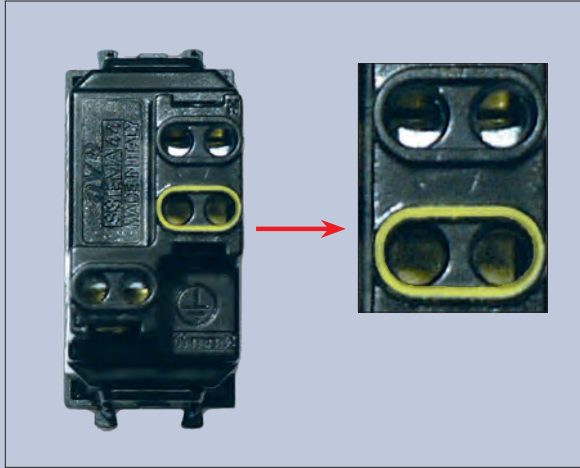

Morsetto di terra evidenziato
per un'immediata identificazione
*Earth terminal highlighted
for immediate identification*

Prese Schuko Schuko Socket Outlets



Prese con sportello *Socket with lid*

Prese illuminate Illuminated socket outlet

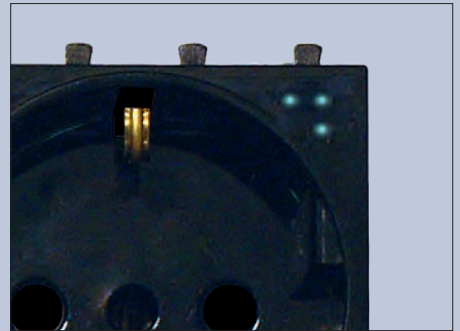

Consigliato l'utilizzo di Lampada a led
colore blu (cod. 0230LDB)
*It is recommended the
use of blue colour led lamp (code 0230LDB)*

Prese Standard Italiano 1 modulo Italian Standard Socket Outlet 1 module



2 prese cablate con ponticello isolato
2 sockets wired with insulated jumper



Per la disponibilità contattare
la rete commerciale
For availability please contact
sales dept.



Disponibilità fino ad
esaurimento scorte
Available until stock out



Prodotto per scatola
rettangolare inglese
Product for British standard
rectangular box



Prodotto
per Export
For Export
only

Prese di corrente standard italiano 250V~ 250V~ Italian standard socket outlets

Life 44	Allumia	Descrizione Description	Info	€	□	□
		■ 442006/15TS ■ 443006/15TS Presa bipasso P17/11 2P+T 10/16A - alveoli schermati - possibilità di utilizzo del ponticello isolato cod. 442PONTE per il cablaggio rapido di più prese affiancate - 1 modulo <i>Combined P17/11 Italian standard socket 2P+E 10/16A - shuttered - possibility of using insulated jumper code 442PONTE for rapid wiring of more sockets side by side - 1 module</i>		■ 11,31 ■ 9,78	10	100
		■ 442006TS ■ 443006TS Presa P11 2P+T 10A - alveoli schermati - possibilità di utilizzo del ponticello isolato cod. 442PONTE per il cablaggio rapido di più prese affiancate - 1 modulo <i>P11 2P+E 10A socket - shuttered - possibility of using insulated jumper code 442PONTE for rapid wiring of more sockets side by side - 1 module</i>		■ 9,04 ■ 8,33	10	100
		■ 442090TS ■ 443090TS Presa schuko P30 2P+T 16A - alveoli schermati - illuminabile (segnalazione presenza rete) - contatti di terra laterale e centrale - 2 moduli <i>P30 2P+E 16A Schuko socket - shuttered - lightable (indicating the line presence) - lateral and central earth contacts - 2 modules</i>		■ 19,95 ■ 18,51	5	50
		■ 442090TSS ■ 443090TSS Presa schuko P30 2P+T 16A con sportello - alveoli schermati - contatti di terra laterale e centrale - 2 moduli <i>P30 2P+E 16A Schuko socket with lid - shuttered - lateral and central earth contacts - 2 modules</i>		■ 22,05 ■ 20,67	5	50
		■ 442090/15TS ■ 443090/15TS Presa schuko bipasso (UNIVERSALE) 2P+T 10/16A - alveoli schermati - illuminabile (segnalazione presenza rete) - 2 moduli <i>2P+E 10/16A (UNIVERSAL) combined Schuko + Italian standard socket - shuttered - lightable (indicating the line presence) - 2 modules</i>		■ 22,11 ■ 19,16	5	50
		■ 442PONTE Ponticello isolato per cablaggio rapido di 2 prese affiancate standard italiano 1 modulo - unico blocco fase/terra/neutro - consigliato l'utilizzo con cavi di sezione 2,5 mm ² o 4 mm ² <i>Insulated jumper for rapid wiring of 2 Italian standard 1 module sockets side by side single block phase/earth/neutral. It is recommended the use of 2,5 mm² or 4 mm² cables</i>		■ 0,99	50	50
		Nota: gli articoli illuminabili sono forniti senza lampada di segnalazione Note: lightable articles are supplied without lamp				

Prese per rasoi 240V~ 240V~ shaver sockets

Life 44	Allumia	Descrizione Description	Info	€	□	□
		■ 442033RS ■ 443033RS Presa per rasoi con trasformatore di isolamento 20VA - standard euroamericano - alimentazione 240V~ o 120V~ - tensione prelevabile in uscita selezionabile tramite commutatore 240V~ o 120V~ - alveoli schermati - 3 moduli <i>Shaver socket with 20VA insulating transformer - Euro-American standard - 240V~ power supply - selectable output voltage 240V~ or 120V~ - shuttered 3 modules</i>		■ 131,12 ■ 125,29	1	1
		Nota: la presa è munita di dispositivo di autoprotezione contro il sovraccarico Note: the socket is supplied with a built-in surge protection device				



Sistema 45











Serie Life - Allumia

Life - Allumia series



Prese di corrente per linee dedicate 250V~
Socket outlets for dedicated circuits 250V~

142

		Descrizione Description	Info	€		
		<p>■ 442006/15TSR Presa bipasso P17/11 2P+T 10/16A - alveoli schermati - rossa - possibilità di utilizzo del ponticello isolato cod. 442PONTE per il cablaggio rapido di più prese affiancate - 1 modulo <i>Combined P17/11 Italian standard socket 2P+E 10/16A - shuttered - red - possibility of using insulated jumper code 442PONTE for rapid wiring of more sockets side by side - 1 module</i></p>	■ 9,39		10	100
442006/15TSR	442090/15TSR	<p>■ 442006/15TSV Presa bipasso P17/11 2P+T 10/16A - alveoli schermati - verde - possibilità di utilizzo del ponticello isolato cod. 442PONTE per il cablaggio rapido di più prese affiancate - 1 modulo <i>Combined P17/11 Italian standard socket 2P+E 10/16A - shuttered - green - possibility of using insulated jumper code 442PONTE for rapid wiring of more sockets side by side - 1 module</i></p>	■ 9,39		10	100
		<p>■ 442006/15TSA Presa bipasso P17/11 2P+T 10/16A - alveoli schermati - arancione - possibilità di utilizzo del ponticello isolato cod. 442PONTE per il cablaggio rapido di più prese affiancate - 1 modulo <i>Combined P17/11 Italian standard socket 2P+E 10/16A - shuttered - orange - possibility of using insulated jumper code 442PONTE for rapid wiring of more sockets side by side - 1 module.</i></p>	■ 9,39		10	100
442006/15TSV	442090/15TSV	<p>■ 442090TSR Presa schuko P30 2P+T 16A - alveoli schermati - rossa - illuminabile (segnalazione presenza rete) - contatti di terra laterale e centrale - 2 moduli <i>P30 2P+E 16A Schuko socket - shuttered - red - lightable (indicating the line presence) - lateral and central earth contacts - 2 modules</i></p>	■ 13,85		5	50
		<p>■ 442090/15TSR Presa schuko bipasso (UNIVERSALE) 2P+T 10/16A - alveoli schermati - rossa - illuminabile (segnalazione presenza rete) - 2 moduli <i>2P+E 10/16A (UNIVERSAL) Schuko + Italian standard socket - shuttered - red - lightable (indicating the line presence) - 2 modules</i></p>	■ 16,98		5	50
442006/15TSA	442090/15TSA	<p>■ 442090/15TSV Presa schuko bipasso (UNIVERSALE) 2P+T 10/16A - alveoli schermati - verde - illuminabile (segnalazione presenza rete) - 2 moduli <i>2P+E 10/16A (UNIVERSAL) Schuko + Italian standard socket - shuttered - green - lightable (indicating the line presence) - 2 modules</i></p>	■ 16,98		5	50
		<p>■ 442090/15TSA Presa schuko bipasso (UNIVERSALE) 2P+T 10/16A - alveoli schermati - arancione - illuminabile (segnalazione presenza rete) - 2 moduli <i>2P+E 10/16A (UNIVERSAL) Schuko + Italian standard socket - shuttered - orange - lightable (indicating the line presence) - 2 modules</i></p>	■ 16,98		5	50
442090TSR		<p>■ 442092TSR Presa standard francese 2P+T 16A - alveoli schermati - rossa - con terra - illuminabile (segnalazione presenza rete) - 2 moduli <i>2P+E 16A French standard socket - shuttered - red - with earth - lightable (indicating the line presence) - 2 modules</i></p>	■ 14,13		5	50
						
442092TSR						

Nota: gli articoli illuminabili sono forniti senza lampada di segnalazione
Nota: lightable articles are supplied without lamp



Per la disponibilità contattare la rete commerciale
For availability please contact sales dept.



Disponibilità fino ad esaurimento scorte
Available until stock out

























Prodotto per scatola rettangolare inglese
Product for British standard rectangular box

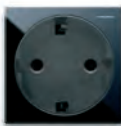

Prodotto per Export
For Export only

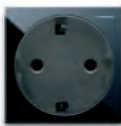
Prese di corrente standard esteri
Various standards socket outlets

Life 44	Allumia	Descrizione Description	Info	€	□	□
 442033S	 443033S	<p>■ 442033S ■ 443033S</p> <p>Presse polarizzata euroamericana 2P 16A 250V~ - alveoli schermati - possibilità di utilizzo del ponticello isolato cod. 442PONTE per il cablaggio rapido di più prese affiancate - 1 modulo</p> <p><i>2P 16A 250V~ Euro-American polarized socket - shuttered - possibility of using insulated jumper code 442PONTE for rapid wiring of more sockets side by side - 1 mod.</i></p>		<p>■ 13,13</p> <p>■ 12,05</p>	10	100
 442033TD	 443033TD	<p>■ 442033TD ■ 443033TD</p> <p>Presse polarizzata euroamericana 2P+T 16A 127~/250V~ - con terra laterale - alveoli non schermati - 1 modulo</p> <p><i>2P+E 16A 127~/250V~ Euro-American polarized socket - with lateral earth - not shuttered - 1 module</i></p>		<p>■ 14,10</p> <p>■ 13,22</p>	10	100
 442033TD2/3	 443033TD2/3	<p>■ 442033TD2/3 ■ 443033TD2/3</p> <p>Doppia prese polarizzata euroamericana 2P+T 16A 127~/250V~ - 3 morsetti (non necessario l'utilizzo di cavallotti) - alveoli non schermati - 3 moduli</p> <p><i>2P+E 16A 127~/250V~ Euro-American double polarized socket 3 terminals (U-brackets not necessary) - not shuttered - 3 modules</i></p>		<p>■ 21,88</p> <p>■ 20,75</p>	2	2
 442034	 443034S	<p>■ 442034</p> <p>Presse 2P 16A 250V~ - alveoli Ø 4,8 mm - alveoli non schermati - possibilità di utilizzo del ponticello isolato cod. 442PONTE per il cablaggio rapido di più prese affiancate - 1 modulo</p> <p><i>2P 16A 250V~ socket - pins with 4,8 mm diameter - not shuttered - possibility of using insulated jumper code 442PONTE for rapid wiring of more sockets side by side - 1 module</i></p>		<p>■ 7,73</p>	10	100
 442034	 443034S	<p>■ 443034S</p> <p>Presse 2P 16A 250V~ - alveoli Ø 4,8 mm - alveoli schermati - possibilità di utilizzo del ponticello isolato cod. 442PONTE per il cablaggio rapido di più prese affiancate - 1 modulo</p> <p><i>2P 16A 250V~ socket - pins with 4,8 mm diameter - shuttered - possibility of using insulated jumper code 442PONTE for rapid wiring of more sockets side by side - 1 module</i></p>		<p>■ 7,62</p>	10	100
 442059TS	 443059TS	<p>■ 442059TS ■ 443059TS</p> <p>Presse multistandard 2P+T 5/6/10/13A 250V~ - alveoli schermati - 2 moduli</p> <p><i>2P+E 5/6/10/13A 250V~ multistandard socket - 2 modules</i></p>		<p>■ 13,59</p> <p>■ 12,60</p>	10	10
 442090S	 443090S	<p>■ 442090S ■ 443090S</p> <p>Presse standard tedesco 2P+T 16A 250V~ - alveoli schermati - illuminabile (segnalazione presenza rete) - 2 moduli</p> <p><i>2P+E 16A 250V~ German standard socket - shuttered - lightable (indicating the line presence) - 2 modules</i></p>		<p>■ 20,93</p> <p>■ 18,38</p>	5	50
 442090S	 443090SS	<p>■ 443090SS</p> <p>Presse standard tedesco 2P+T 16A 250V~ con sportello - alveoli schermati - da utilizzare in scatole con profondità minima 45 mm - 2 moduli</p> <p><i>2P+E 16A 250V~ German standard socket with lid - shuttered - to be used in boxes with min. depth 45 mm - 2 modules</i></p>		<p>■ 21,33</p>	5	50



Sistema 45











Serie Life - Allumia

Life - Allumia series



Prese di corrente standard esteri
Various standards socket outlets

144

Life 44	Allumia	Descrizione Description	Info	€	□	□
 442092TS	 443092TS	<p>■ 442092TS ■ 443092TS</p> <p>Presse standard francese 2P+T 16A 250V~ - alveoli schermati - con terra - illuminabile (segnalazione presenza rete) - 2 moduli 2P+E 16A 250V~ French standard socket outlet - shuttered - with earth - lightable (indicating the line presence) - 2 modules</p>	△	■ 18,99 ■ 17,63	5	50
 442092TSS	 443092TSS	<p>■ 442092TSS ■ 443092TSS</p> <p>Presse standard francese 2P+T 16A 250V~ con sportello - alveoli schermati - con terra - da utilizzare in scatole con profondità minima 45 mm - 2 moduli 2P+E 16A 250V~ French standard socket with lid - shuttered - to be used in boxes with min. depth 45 mm - 2 modules</p>	△	■ 20,71 ■ 19,20	5	50
 442097TS	 443097TS	<p>■ 442097TS ■ 443097TS</p> <p>Presse standard inglese BS1363 2P+T 13A 250V~ - alveoli schermati - illuminabile (segnalazione presenza rete) - 2 moduli 2P+E 13A 250V BS1363 British standard socket outlet - shuttered - lightable (indicating the line presence) - 2 modules</p>	△	■ 20,98 ■ 20,07	5	50
 442097TS/5A	 443097TS/5A	<p>■ 442097TS/5A ■ 443097TS/5A</p> <p>Presse standard inglese BS546 2P+T 5A 250V~ - alveoli schermati - illuminabile (segnalazione presenza rete) - 2 moduli 2P+E 5A 250V BS546 British standard socket - shuttered - lightable (indicating the line presence) - 2 modules</p>	△	■ 18,67 ■ 17,47	5	50

Note: ✓ 44..033S, 44..033TD, 44..033TD2/3, 44..034, 44..034S, 44..098T2/3 utilizzabili solo in paesi non membri dell'Unione Europea

✓ gli articoli illuminabili sono forniti senza lampada di segnalazione

Notes: ✓ 44..033S, 44..033TD, 44..033TD2/3, 44..034, 44..034S, 44..098T2/3 must be used only in non-Eu countries

✓ lightable articles are supplied without lamp



Per la disponibilità contattare la rete commerciale
For availability please contact sales dept.



Disponibilità fino ad esaurimento scorte
Available until stock out



Prodotto per scatola rettangolare inglese
Product for British standard rectangular box



Prodotto per Export
For Export only

Caricatori USB universali Universal USB charger

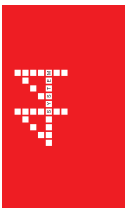

Life 44	Allumia	Descrizione Description	Info	€	□	□
		<p>■ 442082USB3A ■ 443082USB3A</p> <p>Caricatore USB universale 5V 3A - n° 1 uscita USB frontale - alimentazione 110÷240V~ 50-60 Hz - assorbimento a riposo < 0,1 W - consente la ricarica di telefoni cellulari, riproduttori audio portatili, console portatili e ogni altro apparecchio elettronico che offra la possibilità di ricarica da una qualsiasi presa standard USB - 1 modulo</p> <p><i>Universal USB charger 5V 3A - 1 frontal USB output - powered with 110÷230V~ 50-60 Hz - stand-by consumption < 0,1 W - It allows the charging of mobile phones, mobile audio player, and all electronic devices with charging system through standard USB Inputs - 1 module</i></p>		<p>■ 32,02 1 1</p> <p>■ 30,02</p>		
442082USB3A	443082USB3A					

145







Sistema 45

Prese telefoniche Telephone socket outlets

Life 44	Allumia	Descrizione Description	Info	€	□	□
		<p>■ 442024 ■ 443024</p> <p>Presa telefonica RJ11 (6 poli / 4 contatti) - morsetti a vite - 1 modulo</p> <p><i>RJ11 Telephone socket (6 poles / 4 contacts) - screw terminals - 1 module</i></p>		<p>■ 24,31 1 12</p> <p>■ 23,68</p>		
442024	443024					

Adattatori per connettori RJ45 e connettori di segnale AVE con aggancio Keystone Adaptors for RJ45 connectors and AVE signal connectors with Keystone clipping

Life 44	Allumia	Descrizione Description	Info	€	□	□
		<p>■ 442029SC ■ 443029SC</p> <p>Adattatore per connettori RJ45 3M, AT&T, CEAM-QUBIX, KRONE, CLIPSAL, AMPHENOL, FANTON o connettori AVE RJ11, RJ45, RCA, TV, ecc. - 1 modulo</p> <p><i>Adaptor for RJ45 3M, AT&T, CEAM-QUBIX, KRONE, CLIPSAL, AMPHENOL, FANTON or AVE RJ11, RJ45, RCA, TV, etc. connectors - 1 module</i></p>		<p>■ 7,50 4 4</p> <p>■ 7,09</p>		
442029SC 442030SC	443029SC 443030SC	<p>■ 442030SC ■ 443030SC</p> <p>Adattatore per connettori RJ45 AMP, RSX, BRAND-REX - 1 modulo</p> <p><i>Adaptor for RJ45 AMP, RSX, BRAND-REX connectors - 1 module</i></p>		<p>■ 7,45 4 4</p> <p>■ 7,02</p>		
		<p>■ 443032SC</p> <p>Adattatore per connettori RJ45 Infra+ Schneider Electric - 1 modulo</p> <p><i>Adaptor for RJ45 Infra + Schneider Electric connectors - 1 module</i></p>		<p>■ 7,63 4 4</p>		
	443032SC	<p>■ 442029SC/2C ■ 443029SC/2C</p> <p>Adattatore per n° 2 connettori AVE TV, RCA, BNC, USB, HDMI - 1 modulo</p> <p><i>Adaptor for n. 2 AVE TV, RCA, BNC, USB, HDMI connectors - 1 module</i></p>		<p>■ 7,65 4 4</p> <p>■ 7,19</p>		
		<p>Nota: 44..029SC, 44..030SC 44..032SC prevedono, nella parte superiore, vetrino trasparente e relativo cartellino per consentire all'installatore/utente l'identificazione del tipo di presa</p> <p>Note: 44..029SC, 44..030SC 44..032SC - on the upper part there is a transparent glass with card to allow the installer/user to identify the outlet type</p>				
442029SC/2C	443029SC/2C					

Le dimensioni, salvo diversamente specificato, sono in mm
Dimensions, except where otherwise specified, are in mm

 Imballo Minimo pcs
Min. Packaging pcs

 Imballo Standard pcs
Std. Packaging pcs

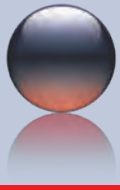

Serie Life - Allumia

Life - Allumia series

NEW WIRING ACCESSORIES

Prese dati
Data socket outlets

Caratteristiche Tecniche Technical Features

Cablaggio universale T568A e T568B Universal wiring T568A and T568B

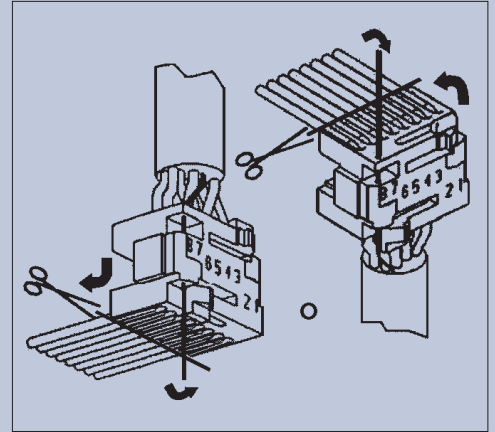
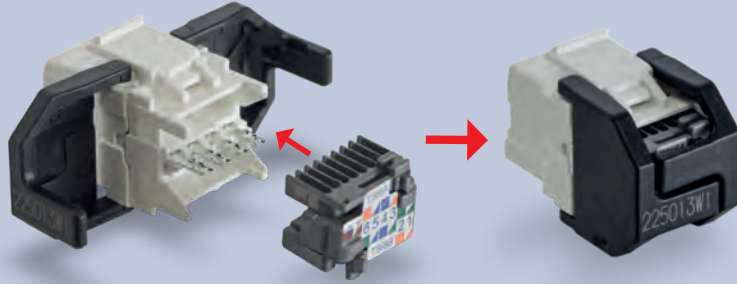

Non necessita di apposito attrezzo per i conduttori
The special tool for conductors is not required

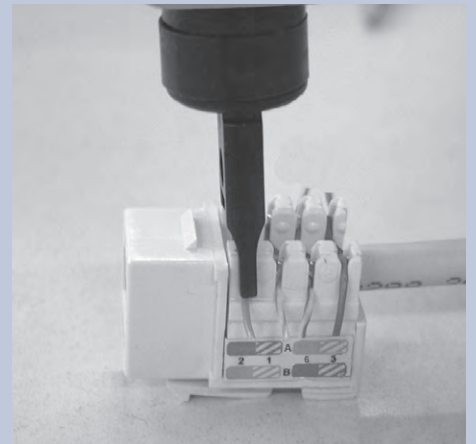

Connettori Ave, usare l'apposito attrezzo per premere i conduttori
Ave connectors, use the special tool to press the conductors

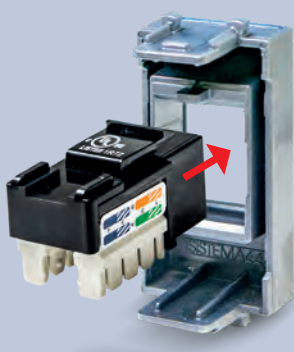

Aggancio
Coupling

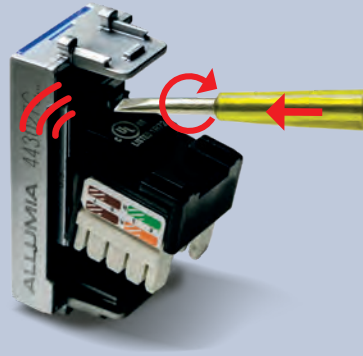

Sgancio
Uncoupling



Cartellino identificativo
Identification card





☎ Per la disponibilità contattare la rete commerciale
For availability please contact sales dept.

⌚ Disponibilità fino ad esaurimento scorte
Available until stock out

Prodotto per scatola rettangolare inglese
Product for British standard rectangular box

△ Prodotto per Export
For Export only





Prese dati
Data socket outlets

Life 44	Allumia	Descrizione Description	Info	€	□	□
		■ 442029C5E ■ 443029C5E Presa RJ45 categoria 5 enhanced - non schermata - connettore 3M - morsetti ad incisione d'isolante con cablaggio rapido - cablaggio universale T568A e T568B - 8 contatti - sportellino antipolvere integrato nel connettore - 1 modulo <i>RJ45 category 5 enhanced outlet - not shuttered - 3M connector - insulation piercing terminals with rapid wiring - T568A and T568B universal wiring 8 contacts - anti-dust lid integrated in the connector - 1 module</i>		■ 28,02 1 10 ■ 26,50		
442029C5E 442029C6	443029C5E 443029C6	■ 442029C6 ■ 443029C6 Presa RJ45 categoria 6 - non schermata - connettore 3M - morsetti ad incisione d'isolante con cablaggio rapido - cablaggio universale T568A e T568B - 8 contatti - sportellino antipolvere integrato nel connettore - 1 modulo <i>RJ45 category 6 outlet - not shuttered - 3M connector - insulation piercing terminals with rapid wiring - T568A and T568B universal wiring - 8 contacts - anti-dust lid integrated in the connector - 1 module</i>		■ 28,95 1 10 ■ 27,15		
		■ 442029C6S ■ 443029C6S Presa RJ45 categoria 6 - schermata - connettore 3M - morsetti ad incisione d'isolante con cablaggio rapido - cablaggio universale T568A e T568B - 8 contatti - sportellino antipolvere integrato nel connettore - 1 modulo <i>RJ45 category 6 outlet- shuttered - 3M connector - insulation piercing terminals with rapid wiring - T568A and T568B universal wiring - 8 contacts - anti-dust lid integrated in the connector - 1 module</i>		■ 34,62 1 10 ■ 31,56		
442029C6S	443029C6S	■ 442029C6AS ■ 443029C6AS Presa RJ45 categoria 6a FTP - schermata - morsetti ad incisione d'isolante con cablaggio rapido - cablaggio universale T568A e T568B - 8 contatti - sportellino antipolvere integrato nel connettore - 1 modulo <i>RJ45 category 6a FTP outlet- shuttered - AVE connector - insulation piercing terminals with rapid wiring T568A and T568B universal wiring - 8 contacts - anti-dust lid integrated in the connector - 1 module</i>		■ 33,65 1 10 ■ 33,06		
						
442029C6AS	443029C6AS					

Nota: previsto, nella parte superiore, vetrino trasparente e relativo cartellino per consentire all'installatore/utente l'identificazione del tipo di presa
Note: on the upper part there is a transparent glass with card to allow the installer/user to identify the socket outlet type



Prese dati Data socket outlets

Life 44	Allumia	Descrizione Description	Info	€	□	□
		■ 442027C5E ■ 443027C5E Presa RJ45 categoria 5 enhanced - non schermata - connettore AVE - morsetti ad incisione d'isolante - cablaggio universale T568A e T568B - 8 contatti - 1 modulo <i>RJ45 category 5 enhanced outlet - not shuttered - AVE connector - insulation piercing terminals - T568A and T568B universal wiring - 8 contacts - 1 module</i>		■ 14,38 1 10 ■ 13,88		
442027C5E	443027C5E	■ 442027C6 ■ 443027C6 Presa RJ45 categoria 6 - non schermata - connettore AVE - morsetti ad incisione d'isolante - cablaggio universale T568A e T568B - 8 contatti - 1 modulo <i>RJ45 category 6 outlet - not shuttered - AVE connector - insulation piercing terminals - T568A and T568B universal wiring - 8 contacts - 1 module</i>		■ 17,01 1 10 ■ 16,59		
						
442027C6	443027C6					

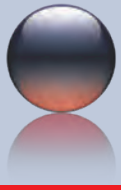

Serie Life - Allumia

Life - Allumia series



Prese TV passanti
Through line TV outlet

Caratteristiche Tecniche Technical Features

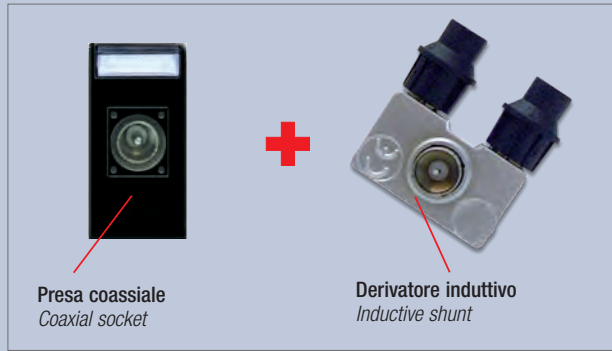

Applicazione cartellino per diversificazione TV/SAT Application of the card to differentiate TV/SAT



CAP

Collegamento Connection

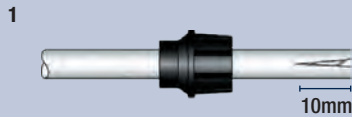

Taglio trasversale guaina
Cross cut on sheath

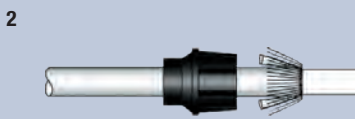

Ripiegamento calza
Fold back braiding

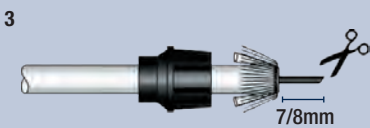

Taglio del dielettrico e del conduttore centrale a 45°
45° cut of the dielectric and central conductor

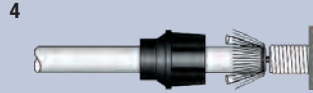

Inserione conduttore centrale su connettore F femmina
Insert central conductor on F-type female connector

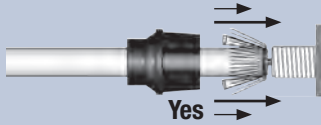
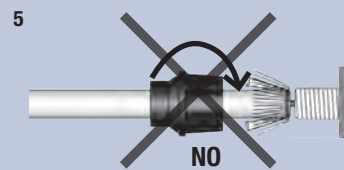

Inserione CAP (non avvitando)
Insert CAP (do not screw)

Estrazione Extraction

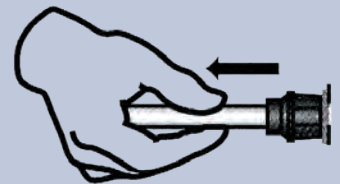

Per la disponibilità contattare la rete commerciale
For availability please contact sales dept.



Disponibilità fino ad esaurimento scorte
Available until stock out



Prodotto per scatola rettangolare inglese
Product for British standard rectangular box



Prodotto per Export
For Export only

Prese TV Ø 9,5 mm
TV socket outlets Ø 9,5 mm

Life 44	Allumia	Descrizione Description	Info	€	□	□
		442096MSI 443096MSI Presa TV diretta isolata con porta utente IEC 60169-2 maschio - per frequenze 4-2400 MHz - attenuazione di derivazione 1dB - NON permette il passaggio di corrente continua e segnali di controllo - collegamento in ingresso mediante morsetto a vite - 1 modulo <i>Direct isolated TV socket with male IEC 60169-2 outlet - for frequencies 4-2400 MHz - attenuation 1dB - it does NOT allow the direct current and control signals passage - input connection through screw terminal - 1 module</i>	■ 27,56 1 10 ■ 25,59			
Nota: previsto, nella parte superiore, vetrino trasparente e relativo cartellino per consentire all'installatore/utente l'identificazione del tipo di presa Note: on the upper part there is a transparent glass with card to allow the installer/user to identify the outlet type						

Prese TV/SAT con CAP - Ø 9,5 mm - Accessori TV/SAT socket outlets - Ø 9,5 mm - Accessories

Life 44	Allumia	Descrizione Description	Info	€	□	□
		442096IM 443096IM Presa coassiale TV/SAT diretta con porta utente IEC 60169-2 maschio per frequenze fino a 2400 MHz - collegamento in ingresso mediante connettore maschio tipo F - fornita con connettore plastico (CAP) per la connessione in ingresso del cavo coassiale - 1 modulo <i>TV/SAT direct coaxial socket with IEC 60169-2 male connector for frequencies until 2400 MHz - incoming connection through F male connector - supplied with plastic connector (CAP) for coaxial cable connection - 1 module</i>	■ 19,78 1 12 ■ 19,22			
		442096F 443096F Presa coassiale TV/SAT diretta con porta utente femmina tipo F per frequenze fino a 2400 MHz - collegamento in ingresso e in uscita mediante connettore maschio tipo F - fornita con connettore plastico (CAP) per la connessione in ingresso del cavo coassiale - 1 modulo <i>TV/SAT direct coaxial socket with F female connector for frequencies until 2400 MHz - incoming and outgoing connection through F male connector - supplied with plastic connector (CAP) for coaxial cable connection - 1 module</i>	■ 17,08 1 12 ■ 15,52			
		442096IF 443096IF Presa coassiale TV/SAT diretta con porta utente IEC 60169-2 femmina per frequenze fino a 2400 MHz - collegamento in ingresso mediante connettore maschio tipo F - fornita con connettore plastico (CAP) per la connessione in ingresso del cavo coassiale - 1 modulo <i>TV/SAT direct coaxial socket with IEC 60169-2 female connector for frequencies until 2400 MHz - incoming connection through F male connector - supplied with plastic connector (CAP) for coaxial cable connection - 1 module</i>	■ 17,41 2 12 ■ 15,84			
		442096DM 443096DM Presa TV - SAT diretta demiscelata, 2 uscite con connettore maschio (TV) e connettore tipo F (SAT) - per frequenze 5-2400 MHz - attenuazione di derivazione 1dB - permette il passaggio di corrente continua e segnali di controllo (24V 500mA max) - collegamento in ingresso mediante morsetto a vite - 1 modulo <i>TV/SAT demixed direct socket, 2-outputs with male connector (TV) and type F (SAT) connector - for frequencies 5-2400 MHz - attenuation 1dB - it allows the passage of direct current and control signals (24V 500mA max) - incoming connection with screw terminal - 1 module</i>	■ 43,55 1 1 ■ 41,49			
		TVDER-DB6 Derivatore induttivo TV/SAT ad innesto su presa 44..096IM, 44..096IF, 44..096F - attenuazione di derivazione 6dB <i>TV/SAT inductive shunt to be connected to 44..096IM, 44..096IF, 44..096F - attenuation 6dB</i>	■ 10,31 1 6			
		TVDER-DB10 Derivatore induttivo TV/SAT ad innesto su presa 44..096IM, 44..096IF, 44..096F - attenuazione di derivazione 10dB <i>TV/SAT inductive shunt to be connected to 44..096IM, 44..096IF, 44..096F - attenuation 10dB</i>	■ 10,09 1 6			
		TVDER-DB14 Derivatore induttivo TV/SAT ad innesto su presa 44..096IM, 44..096IF, 44..096F - attenuazione di derivazione 14dB <i>TV/SAT inductive shunt to be connected to 44..096IM, 44..096IF, 44..096F - attenuation 14dB</i>	■ 10,09 1 6			
Nota: ✓ 44..096IM, 44..096F, 44..096IF prevedono nella parte superiore, vetrino trasparente e relativo cartellino per consentire all'installatore/utente l'identificazione del tipo di presa ✓ TVDER-DB... permettono la trasformazione delle prese 44..096IM, 44..096IF, 44..096F da dirette a passanti Note: ✓ 44..096IM, 44..096F, 44..096IF - on the upper part there is a transparent glass with card to allow the installer/user to identify the outlet type ✓ TVDER-DB... they allow to change the 44..096IM, 44..096IF, 44..096F outlets from direct to through-line						

Sistema 45







Serie Life - Allumia

Life - Allumia series

Prese TV/SAT Ø 9,5 mm
TV/SAT socket outlets Ø 9,5 mm





150

Life 44	Allumia	Descrizione Description	Info	€	□	□
 442096M	 443096M	<p>■ 442096M ■ 443096M</p> <p>Presse TV/SAT diretta con porta utente IEC 60169-2 maschio - per frequenze 4÷2400 MHz - attenuazione di derivazione 1dB - permette il passaggio di corrente continua e segnali di controllo (24V 300mA max) - collegamento in ingresso mediante morsetto a vite - 1 modulo</p> <p><i>Direct TV/SAT outlet with male IEC 60169-2 connector - for frequencies 4÷2400 MHz - attenuation 1dB - it allows the passage of direct current and control signals (24V 300mA max) - input connection through screw terminals - 1 module</i></p>	<p>■ 27,30 1 10</p> <p>■ 25,07</p>			
 442096M/DB6 442096M/DB10	 443096M/DB6	<p>■ 442096M/DB6 ■ 443096M/DB6</p> <p>Presse TV/SAT passante con porta utente IEC 60169-2 maschio - per frequenze 4÷2400 MHz - attenuazione di derivazione 6dB - collegamento in ingresso mediante morsetto a vite - 1 modulo</p> <p><i>Through-line TV/SAT outlet with male IEC 60169-2 connector - for frequencies 4÷2400 MHz - attenuation 6dB - input connection through screw terminal - 1 module</i></p>	<p>■ 35,07 1 10</p> <p>■ 32,85</p>			
		<p>■ 442096M/DB10</p> <p>Presse TV/SAT passante con porta utente IEC 60169-2 maschio - per frequenze 4÷2400 MHz - attenuazione di derivazione 10dB - collegamento in ingresso mediante morsetto a vite - 1 modulo</p> <p><i>Through-line TV/SAT outlet with male IEC 60169-2 connector - for frequencies 4÷2400 MHz - attenuation 10dB - input connection through screw terminal - 1 module</i></p>	<p>■ 32,14 1 10</p>			

Nota: previsto, nella parte superiore, vetrino trasparente e relativo cartellino per consentire all'installatore/utente l'identificazione del tipo di presa
Note: on the upper part there is a transparent glass with card to allow the installer/user to identify the type of outlet

Accessori per Impianti Televisivi Accessories for TV systems

	Descrizione Description	Info	€	□	□
 CAP	<p>CAP</p> <p>Connettore plastico per cavi coassiali - consente una connessione rapida ed economica - da utilizzare anche con prese 44..096F, 44..096IM, 44..096IF</p> <p><i>Plastic connector for coaxial cables - it allows a fast and cheap connection - to be used with 44..096F, 44..096IM, 44..096IF sockets</i></p>		0,60	50	50
 TVSPIM	<p>TVSPIM</p> <p>Spina volante TV/SAT schermata per frequenze fino a 2400 MHz - connettore IEC maschio - fornita con n° 1 connettore plastico (CAP) per la connessione</p> <p><i>Shuttered TV/SAT movable plug for frequencies up to 2400 MHz</i></p> <p><i>Male IEC connector - supplied with n.1 plastic connector (CAP)</i></p>		2,74	50	50



Per la disponibilità contattare la rete commerciale
For availability please contact sales dept.



Disponibilità fino ad esaurimento scorte
Available until stock out



Prodotto per scatola rettangolare inglese
Product for British standard rectangular box



Prodotto per Export
For Export only

Interruttori automatici magnetotermici 120-230V~ MCB 120-230V~

Life 44	Allumia	Descrizione Description	Info	€	□	□
		■ 442052X10 ■ 443052X10 Interruttore automatico magnetotermico 1P+N 10A 120-230V~ p.i. 3kA - potenza dissipata 1W - 1 modulo <i>MCB 1P+N 10A 120-230V~ b.c. 3kA - dissipated power 1W - 1 module</i>		■ 80,11 1 10 ■ 78,00		
442052X10	443052X10					
		■ 442052X16 ■ 443052X16 Interruttore automatico magnetotermico 1P+N 16A 120-230V~ p.i. 3kA - potenza dissipata 2,1W - 1 modulo <i>MCB 1P+N 16A 120-230V~ b.c. 3kA - dissipated power 2,1W - 1 module</i>		■ 84,86 1 10 ■ 82,63		
442052X16	443052X16					
Nota: magnetotermici curva C Note: MCB type C						

151

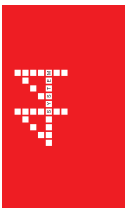

Sistema 45

Interruttori automatici magnetotermici differenziali 120-230V~ SRCBO 120-230V~

Life 44	Allumia	Descrizione Description	Info	€	□	□
		■ 442062X10 ■ 443062X10 Interruttore automatico magnetotermico differenziale 1P+N 10A 120-230V~ $I_{\Delta n}$ 10mA p.i. 3kA - potenza dissipata 1,1W - 2 moduli <i>SRCBO 1P+N 10A 120-230V~ $I_{\Delta n}$ 10mA b.c. 3kA - dissipated power 1,1W - 2 modules</i>		■ 181,59 1 6 ■ 173,41		
442062X10	443062X10					
		■ 442062X16 ■ 443062X16 Interruttore automatico magnetotermico differenziale 1P+N 16A 120-230V~ $I_{\Delta n}$ 10mA p.i. 3kA - potenza dissipata 2,5W - 2 moduli <i>SRCBO 1P+N 16A 120-230V~ $I_{\Delta n}$ 10mA b.c. 3kA - dissipated power 2,5W - 2 modules</i>		■ 190,52 1 6 ■ 181,96		
442062X16	443062X16					
Note: <ul style="list-style-type: none"> ✓ prevedono una segnalazione frontale di alimentazione e contatto chiuso a mezzo led colore verde ✓ magnetotermici curva C - differenziali tipo A Notes: <ul style="list-style-type: none"> ✓ frontal signal of power supply and closed contact through a green led ✓ MCB type C - SRCBO type A 						

Interruttori differenziali puri 120-230V~ RCD 120-230V~

Life 44	Allumia	Descrizione Description	Info	€	□	□
		■ 443062X16/30MA Interruttore differenziale puro 2P 16A 120-230V~ $I_{\Delta n}$ 30mA - potenza dissipata 2,5W - 2 moduli <i>RCD 2P 16A 120-230V~ $I_{\Delta n}$ 30mA - dissipated power 2,5W - 2 modules</i>		a commessa upon request ■ 231,28 1 6		
443062X16/30MA						
Note: <ul style="list-style-type: none"> ✓ prevedono una segnalazione frontale di alimentazione e contatto chiuso a mezzo led colore verde ✓ differenziali tipo A Notes: <ul style="list-style-type: none"> ✓ frontal signal of power supply and closed contact through a green led ✓ RCD type A 						

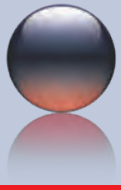

Schema di Collegamento 44..087C Connection Diagram 44..087C

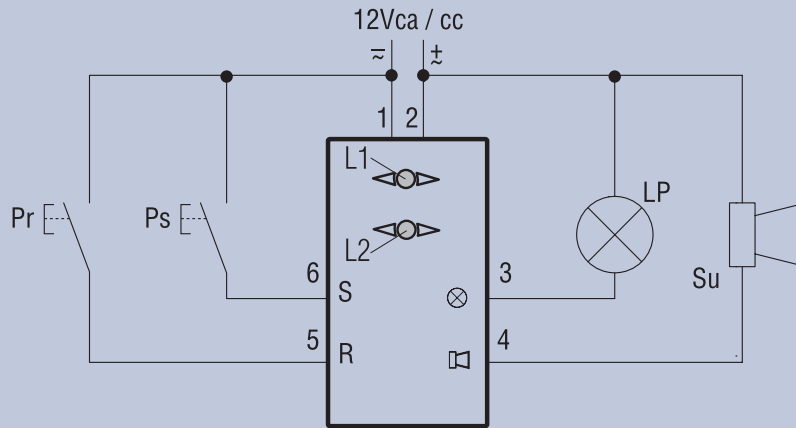

- Nota:** ✓ per il corretto funzionamento del relè è necessario prevedere un trasformatore 12 Vca oppure un alimentatore 12 Vcc opportunamente dimensionati
 ✓ se il relè è alimentato in corrente alternata la tensione efficace sui carichi (lampada e suoneria) è pari alla metà della tensione di alimentazione
- Note:** ✓ for the proper functioning of the relay it is necessary to provide a transformer 12 Vac or a power supply 12 Vdc appropriately sized
 ✓ if the relay is powered in alternating current, the RMS voltage on the loads (lamp and sounder) is equal to the half of powering voltage.

Relè di Chiamata - Sistema di Chiamata Call Relay – Call System

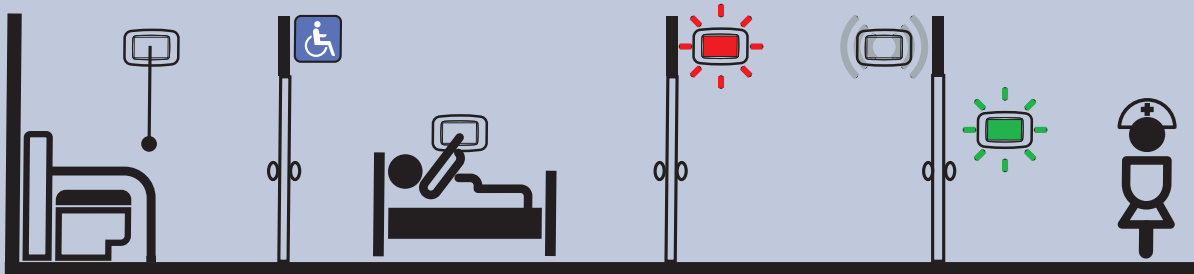

Il paziente agendo sul pulsante effettua una chiamata. Il relè attiva le segnalazioni ottiche ed acustiche nel corridoio e la segnalazione ottica in reception corrispondente al numero del chiamante

By pressing a push button the patient makes a call. The relay activates the visual and sound signals in the corridor and the visual signal at reception corresponding to the caller's number



L'infermiera intervenendo nella camera del paziente effettua l'azione di reset agendo sul pulsante posto nella camera stessa, annullando l'attivazione delle segnalazioni ottiche ed acustiche

The nurse is summoned to the patient's room and can reset by pressing the push-button in the room, cancelling the visual and sound signals.



Per la disponibilità contattare la rete commerciale
 For availability please contact sales dept.



Disponibilità fino ad esaurimento scorte
 Available until stock out





Prodotto per scatola rettangolare inglese
 Product for British standard rectangular box



Prodotto per Export
 For Export only



Relè di chiamata Call Relays

Life 44	Allumia	Descrizione Description	Info	€	□	□
		<p>■ 442087C ■ 443087C</p> <p>Relè statico bistabile (tipo Flip-Flop SR) 12 Vca/cc per impianti di chiamata - 2 uscite: per segnalazione ottica (lampeggiante o fissa) e per segnalazione acustica (suono continuo o temporizzato da 3 secondi a 1 minuto) - attivazione e tacitazione da più punti con normali pulsanti NA collegati in parallelo - 1 modulo</p> <p><i>Static bistable relay (type Flip-Flop SR) 12 Vac/dc for call systems - 2 outputs: for visual signals (flashing or fixed) and acoustic signals (continuous sound or at intervals of 3 seconds to 1 minute) - activated and silenced from various points using normal NO push buttons connected in parallel - 1 module</i></p>	<p>■ 150,17 1 1</p> <p>■ 146,21</p>			









Alimentatori Power supplies

Life 44	Allumia	Descrizione Description	Info	€	□	□
		<p>■ 443082ALI</p> <p>Alimentatore supplementare da incasso - tensione di ingresso: 85÷265V~ 50-60Hz - tensione d'uscita 12 Vcc - corrente erogabile: 400mA a servizio continuo - 1 modulo</p> <p><i>Additional flush mounted power supply - input voltage 85÷265V~ 50-60Hz - output voltage 12 Vdc - suppliable current: 400mA continuous - 1 module</i></p>	<p>■ 82,63 1 1</p>			

Portafusibili 250V~ Fuse Holders 250V~

Life 44	Allumia	Descrizione Description	Info	€	□	□
		<p>■ 442007 ■ 443007</p> <p>Portafusibile per fusibili in miniatura 1P 10A - per fusibili Ø 5x20 mm - fornito senza fusibile - 1 modulo</p> <p><i>Fuse holder for miniature fuses 1P 10A - for fuses Ø 5x20 mm - supplied without fuse - 1 module</i></p>	<p>■ 18,71 1 10</p> <p>■ 17,92</p>			

Suonerie/Ronzatori elettromeccanici Bells / Buzzers

Life 44	Allumia	Descrizione Description	Info	€	□	□
		<p>■ 442028 ■ 443028</p> <p>Suoneria squillante 12V~ 8VA (SELV) - 1 modulo</p> <p><i>Ringling bell 12V~ 8VA (SELV) - 1 module</i></p>	<p>■ 36,14 1 10</p> <p>■ 34,20</p>			
		<p>■ 442029 ■ 443029</p> <p>Suoneria squillante 230V~ - 1 modulo</p> <p><i>Ringling bell 230V~ - 1 module</i></p>	<p>■ 43,20 1 10</p> <p>■ 41,26</p>			
		<p>■ 442030 ■ 443030</p> <p>Ronzatore 12V~ 8VA (SELV) - 1 modulo</p> <p><i>Buzzer 12V~ 8VA (SELV) - 1 module</i></p>	<p>■ 28,55 1 10</p> <p>■ 26,22</p>			
		<p>■ 442031 ■ 443031</p> <p>Ronzatore 230V~ - 1 modulo</p> <p><i>Buzzer 230V~ - 1 module</i></p>	<p>■ 37,48 1 10</p> <p>■ 33,43</p>			

Nota: Utilizzare solo per servizio ad intermittenza. Tempo massimo di utilizzo continuo 5" con relativa pausa di 15"
Note: Use only for intermittent service. Maximum time of continuous use 5 " with relative pause of 15"

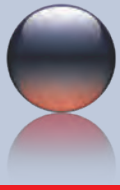

Serie Life - Allumia

Life - Allumia series

Suonerie chiamate d'emergenza elettronica
Emergency call bells



Caratteristiche Tecniche Technical Features

Caratteristiche Features

3 diverse tipologie di segnalazioni acustiche
3 different types of acoustic signals

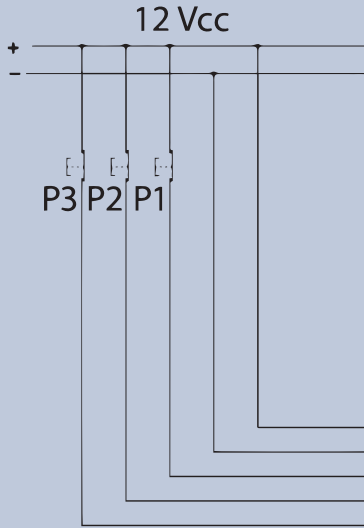

Morsetto n° Terminal n°	Pulsante Push button	Tipo di chiamata Kind of call	Segnalazione acustica Acoustic signaling
3	P1	Chiamata generica Generic call	
4	P2	Chiamata di emergenza Emergency call	
5	P3	Chiamata di allarme Alarm call	

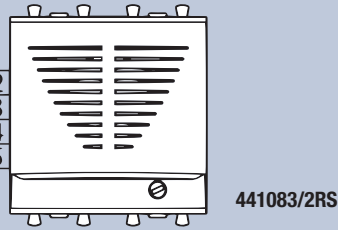

Lampade estraibili Removable lights

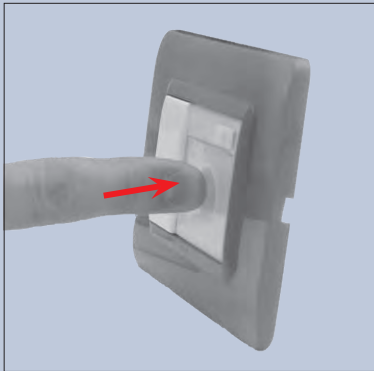

Estrazione lampada: premere sul fronte
Light removal: push on the front

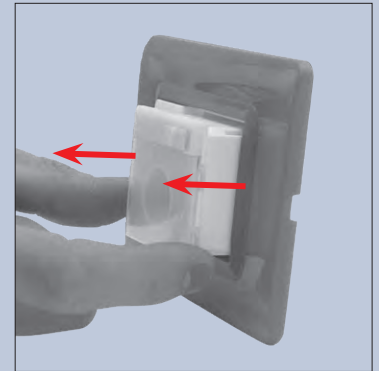
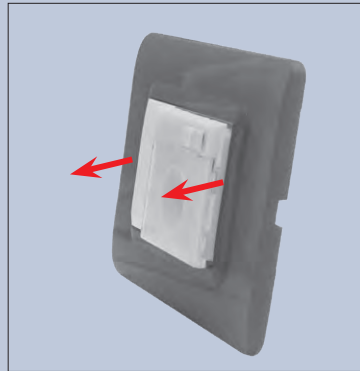

Caratteristiche Features



Gancio appendi-lampada
Light clipping hook

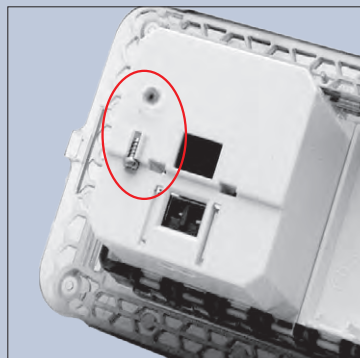

Vite per blocco estrazione lampada
Light anti-removal screw



Sostituzione batteria
Battery replacement







Per la disponibilità contattare la rete commerciale
For availability please contact sales dept.

Disponibilità fino ad esaurimento scorte
Available until stock out

Prodotto per scatola rettangolare inglese
Product for British standard rectangular box

△ Prodotto per Export
For Export only

Suonerie elettroniche Electronic bells

Life 44	Allumia	Descrizione Description	Info	€	□	□
		<p>■ 442081 ■ 443081</p> <p>Segnalatore ausiliario d'allarme con possibilità di temporizzazione suoneria per 5 secondi - alimentazione 12-24 Vcc/ca - assorbimento 12V 4mA / 24V 6mA - possibilità regolazione intensità sonora - pressione acustica 86 dB a 1m - led frontale di segnalazione - 1 modulo</p> <p><i>Auxiliary alarm signal - possibility of setting a timer to ring for 5 second - input 12-24 Vac/dc - absorption 12V 4mA / 24V 6mA - it is possible to adjust the sound volume - acoustic pressure 86 dB at 1m - front signalling led - 1 mod.</i></p>		■ 50,90 ■ 49,58	1	10
		<p>■ 442083 ■ 443083</p> <p>Suoneria elettronica tritonale - alimentazione 12 Vcc/ca - assorbimento 12Vcc 160mA / 24Vca 330mA - possibilità di scelta tra sei diversi suoni acustici - regolazione frontale intensità sonora - led frontale di segnalazione - pressione acustica 71÷76 dB a 1m a seconda del suono attivato - 2 moduli</p> <p><i>Three tone electronic bell - 12 Vac/dc power supply - absorption 12Vcc 160mA / 24Vca 330mA - possibility to choose one out of six tones - frontal sound regulation - frontal signalling led - acoustic pressure 71÷76 dB at 1m according to the sound activated - 2 modules</i></p>		■ 123,21 ■ 110,95	1	6
		<p>■ 441083/2RS</p> <p>Suoneria tritonale 12vcc per sistemi chiamata di emergenza colore rosso - assorbimento 160mA - possibilità scelta tra 3 tipologie di segnalazioni acustiche temporizzate che identificano le seguenti chiamate: GENERICA - EMERGENZA - ALLARME - regolazione frontale intensità sonora da 45 a 65 dB - led frontale - 2 moduli</p> <p><i>12Vdc sounders for emergency call systems, red colour - 160mA absorption - Three different timed sound time options identifying following calls: GENERIC - EMERGENCY - ALARM - frontal trimmer for sound pressure adjustment from 45 to 65 dB - frontal led - 2 modules</i></p>			118,09	1 1



Nota: Per sirena AF442099RS vedere il capitolo Antintrusione
Note: For the AF442099RS siren, refer to the Anti-intrusion section



Lampade segnagrado Step marker lights

Life 44	Allumia	Descrizione Description	Info	€	□	□
		<p>■ 442070B/2 ■ 443070B/2</p> <p>Lampada segnagrado - alimentazione 12-24 Vcc/ca o 230 V~ - led colore blu ad alta efficienza - 2 moduli</p> <p><i>Step marker light - input 12-24 Vac/dc or 230 V~ - high efficiency blue led - 2 modules.</i></p>		■ 51,87 ■ 49,76	1	6
		<p>■ 442070W/2 ■ 443070W/2</p> <p>Lampada segnagrado - alimentazione 12-24 Vcc/ca o 230 V~ - led colore bianco ad alta efficienza - 2 moduli</p> <p><i>Step marker light - input 12-24 Vac/dc or 230 V~ - high efficiency white led - 2 modules</i></p>		■ 51,87 ■ 50,51	1	6

Lampade estraibili portatili Removable portable lights

Life 44	Allumia	Descrizione Description	Info	€	□	□
		<p>■ 442086 ■ 443086</p> <p>Lampada anti blackout estraibile portatile - completa di base di ricarica - completa di batterie ricaricabili e sostituibili - lampada: led colore bianco ad alta efficienza - interruttore frontale per spegnimento in assenza tensione di rete - tempo di ricarica 36 ore - autonomia 3 ore circa - alimentazione 110÷230 V~ - 2 moduli</p> <p><i>Anti blackout removable portable light - with recharging base - with interchangeable and rechargeable batteries - lamp: high efficiency white led - front switch in case of power failure - 36 hours recharge time - 3 hours endurance - 110÷230 V~ power supply - 2 modules</i></p>		■ 144,85 ■ 122,98	1	1
		<p>45786B</p> <p>Batteria (4x1,2)V - 80mAh, di ricambio per 442086 e 443086</p> <p><i>Spare battery for 442086 and 443086 (4x1,2)V - 80mAh</i></p>		14,82	1	1

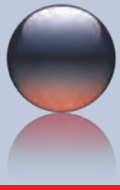

Serie Life - Allumia

Life - Allumia series

Lampada di emergenza
Emergency light



Lampada di emergenza MULTICOMPATIBILE MULTI-COMPATIBLE Emergency light

Caratteristiche Tecniche Technical Features

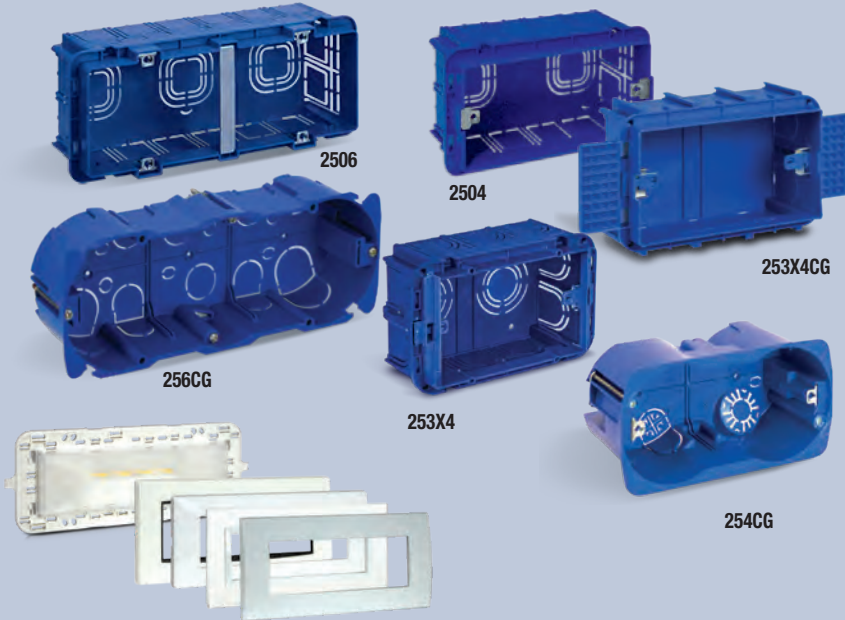

- Flusso luminoso 90 lumen
- Completa di supporto MULTICOMPATIBILE 6/7 moduli
- Installabile sia in scatole da incasso standard 6/7 moduli sia in 4 moduli
- Da completare con placche standard 7 moduli S44 di Ave o con analoghe placche di altri costruttori (Bticino Livinglight, Bticino Living International, Bticino Light, Vimar Eikon, Vimar Plana)
- placche Serie SMART NON INSTALLABILI

- Luminous flux 90 lumen
- Supplied with MULTICOMPATIBLE 6/7 modules frame
- It can be installed both in 6/7 modules standard flush mounted boxes and in 4 modules boxes
- To be completed with AVE S44, 7 mod front plates or with similar front plates by other manufacturers (Bticino Livinglight, Bticino Living International, Bticino Light, Vimar Eikon, Vimar Plana)
- SMART Series front plates NOT INSTALLABLE

Installazione su scatole standard da 4 e 7 moduli
Installation on 4 modules and 7 modules standard boxes

Schema di collegamento Wiring diagram

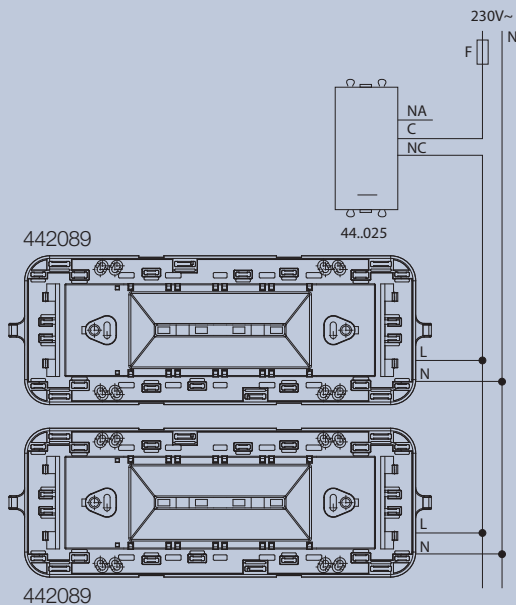

F: Fusibile / Fuse

Curva fotometrica in emergenza Emergency photometric diagram

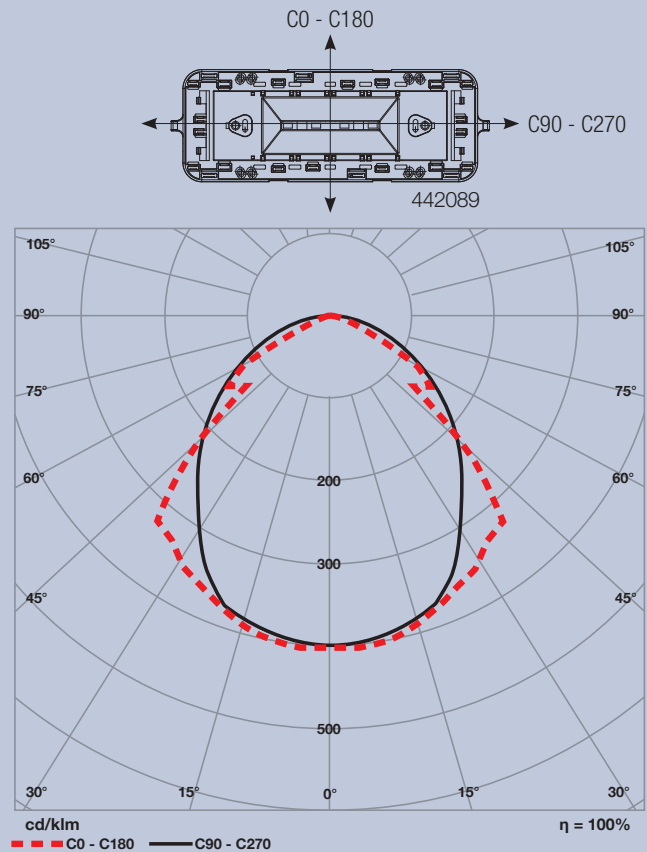

Per la disponibilità contattare la rete commerciale
For availability please contact sales dept.

Disponibilità fino ad esaurimento scorte
Available until stock out

Prodotto per scatola rettangolare inglese
Product for British standard rectangular box

△ Prodotto per Export
For Export only

Lampada di emergenza MULTICOMPATIBILE



MULTI-COMPATIBLE emergency light

Descrizione Description	Info	€	□	□	157
 <p>442089</p> <p>Lampada di emergenza a LED bianchi ad alta efficienza 230 V~ 50/60 Hz - SE - assorbimento in stand-by 5 mA (340 mW) - batteria ricaricabile e sostituibile 3,7 V 700 mAh - tempo di ricarica 12 ore - autonomia 2 ore - autodiagnosi permanente della funzionalità della batteria con segnalazione luminosa in caso di anomalia - flusso luminoso 90 lumen - completa di supporto MULTICOMPATIBILE 6/7 moduli - installabile sia in scatole da incasso standard 6/7 moduli sia in scatole 4 moduli - da completare con placche standard 7 moduli S44 di Ave o con placche di altri costruttori (Bticino Livinglight, Bticino Living International, Bticino Light, Vimar Eikon, Vimar Plana) - <u>placche Serie SMART NON INSTALLABILI</u> - 4x7 moduli</p> <p><i>Emergency light with a white high-efficiency LED 230 V ~ 50/60 Hz - N/M - absorption on stand-by 5 mA (340 mW) - Rechargeable and changeable battery: 3.7 V 700 mAh - Recharge time: 12 hours - 2 hours of endurance - permanent self-diagnosis of the battery functionality with warning light in case of failures - luminous flux 90 lumens - complete with MULTI-COMPATIBLE 6/7 modules frames - installable in standard 6/7 modules flush mounted boxes or in 4 modules boxes - to be completed with Ave S44 standard 7 modules front plates or plates from other manufacturers (Bticino Livinglight, Bticino Living International, BTicino Light, Vimar Eikon, Vimar Plana) - SMART Series front plates NOT INSTALLABLE - 4x7 modules</i></p>		109,97	1	1	
<p>442089B</p> <p>Batteria Li-Ion 3,7 V 700 mAh di ricambio per lampada d'emergenza 442089</p> <p><i>Spare battery Li-Ion 3,7 V 700 mAh for emergency light 442089</i></p>		32,15	1	1	



Nota: Non installabili le placche di finitura della Gamma Smart
Note: The Smart Range finishing front plates cannot be installed



Variatori per agitatori d'aria Dimmers for ceiling fan

Life 44	Allumia	Descrizione Description	Info	€	□	□
 <p>442048AA</p>	 <p>443048AA</p>	<p>■ 442048AA ■ 443048AA</p> <p>Variatore a 3 velocità (+ spegnimento) 55÷80VA 230V~ 50-60Hz - comando con pulsante incorporato o da più punti con normali pulsanti NA - tecnologia che garantisce l'assoluta "silenziosità" - led di individuazione al buio - 1 modulo</p> <p><i>3-speed push button dimmer (+ switch off) 55÷80VA 230V~ 50-60Hz- control by built-in push-button or by normal NO buttons from more points - technology guaranteeing absolute "silence" - led for identification in the dark - 1 module</i></p>		<p>■ 80,14</p> <p>■ 78,77</p>	1	6

Commutatore per fan-coil Rotary switch for fan-coil

Life 44	Allumia	Descrizione Description	Info	€	□	□
 <p>442055</p>	 <p>443055</p>	<p>■ 442055 ■ 443055</p> <p>Commutatore rotativo 1P 3A 250V~ a 4 posizioni per variazione velocità fan-coil (ventil-convettori) - 2 moduli</p> <p><i>1P 3A 250V rotary switch 4 positions for fan coil (convectors) - 2 modules</i></p>		<p>■ 56,43</p> <p>■ 52,87</p>	1	1

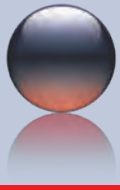

Serie Life - Allumia

Life - Allumia series

Cronotermostato
Chronothermostat



MASSIME PRESTAZIONI per il RISPARMIO ENERGETICO:

- * Differenziale termico minimo: vengono rilevate velocemente variazioni di temperatura in modo da evitare eccessive escursioni della temperatura ambiente controllata.
- * Deriva sotto carico ridotta al minimo, ovvero la variazione tra la temperatura regolata quando il contatto del termostato è a vuoto e quando invece è a pieno carico elettrico.

MAXIMUM PERFORMANCE for ENERGY SAVING:

- * Minimum thermal differential: temperature variations are detected in order to avoid extreme room temperature oscillations
- * Minimized on-duty offset, as to say the variation of the adjusted temperature between no load and full load operating conditions.

Caratteristiche Tecniche Technical Features

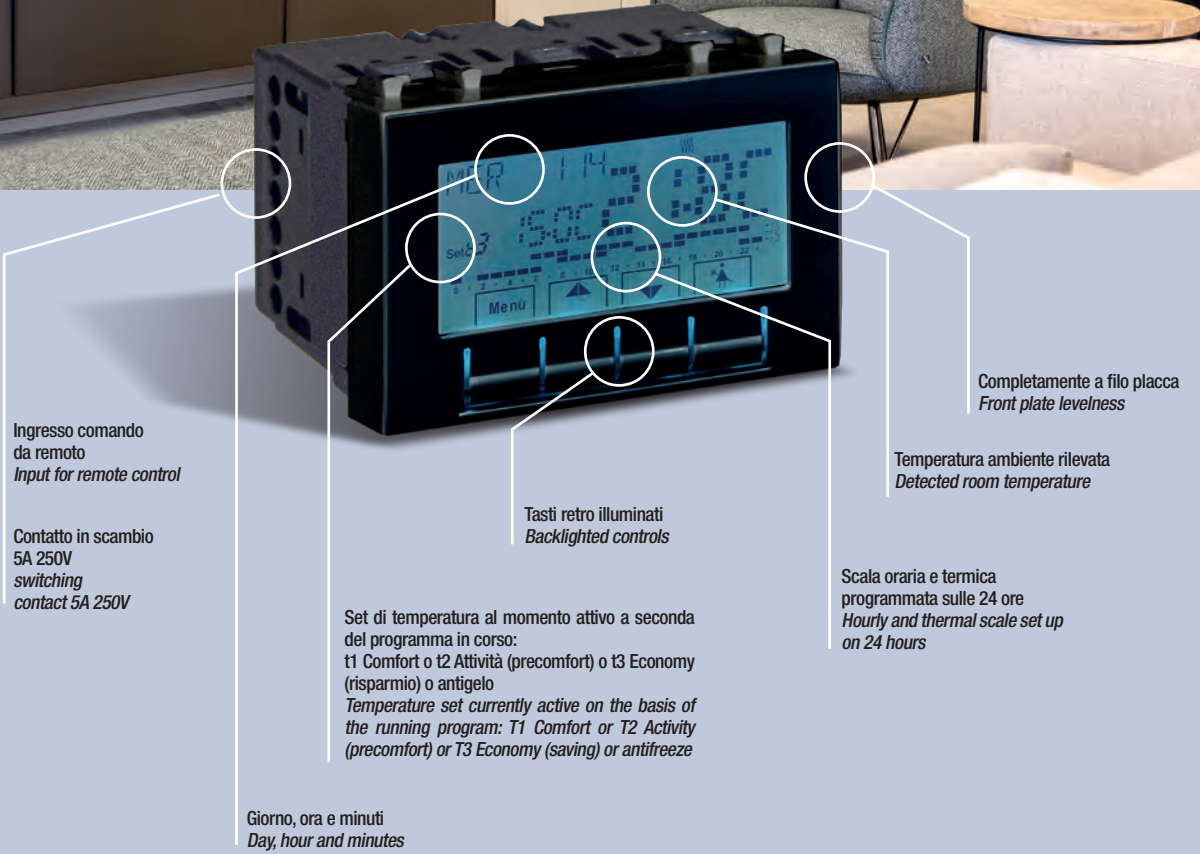

Per la disponibilità contattare la rete commerciale
For availability please contact sales dept.



Disponibilità fino ad esaurimento scorte
Available until stock out







Prodotto per scatola rettangolare inglese
Product for British standard rectangular box



Prodotto per Export
For Export only



Termostati Thermostats

Life 44	Allumia	Descrizione Description	Info	€	□	□	159
		<p>■ 442085 ■ 443085</p> <p>Termostato elettronico a manopola per controllo temperatura ambiente - uscita con contatto in scambio NA+NC 5A (2A induttivi) 230V~ - range regolazione temperatura da 5 °C a 30 °C - alimentazione 230V~ 50-60 Hz - 2 moduli</p> <p><i>Electronic thermostat with rotary knob for room temperature control - switching contact output NO+NC 5A (2A inductive) - temperature range from 5 °C to 30 °C - 230V~ power supply - 50-60 Hz - 2 modules</i></p>		<p>■ 102,81 1 1</p> <p>■ 94,58</p>			
		<p>■ 442085SW ■ 443085SW</p> <p>Termostato elettronico estate/inverno a display retroilluminato per controllo temperatura ambiente (riscaldamento e condizionamento) - uscita con contatto in scambio NA+NC 2A 230V~ - range regolazione temperatura da 0 °C a 35 °C - tasti di comando retroilluminati - ingresso per attivazione a distanza e ingresso per forzatura a temperatura ridotta - alimentazione 230V~ 50-60 Hz - 2 moduli</p> <p><i>Electronic winter/summer thermostat with backlighted display for room temperature control (heating and air-conditioning) - switching contact output NO+NC 2A 230V~ - temperature range from 0 °C to 35 °C - backlighted controls - input for remote activation and input for forcing at reduced temperature - 230V~ power supply - 50-60 Hz - 2 modules</i></p>		<p>■ 176,97 1 1</p> <p>■ 175,73</p>			



Sistema 45

Cronotermostati 230V~ Chronothermostats 230V~

Life 44	Allumia	Descrizione Description	Info	€	□	□
		<p>■ 442CRT3 ■ 443CRT3</p> <p>Cronotermostato elettronico da incasso a filo placca, con display retroilluminato per controllo temperatura ambiente (riscaldamento e condizionamento) - programmazione giornaliera/settimanale uscita con contatto in scambio libero da potenziale NA+NC 5A 250V~ - range regolazione temperatura da 5 °C a 37 °C. Set di programmazione per inibizione pulizie - 4 tasti di comando retroilluminati - ingresso per attivazione a distanza - passaggio automatico all'ora legale/solare - menù con guida testuale multilingue - alimentazione 230V~ 50-60 Hz - 3 moduli.</p> <p><i>Flush-mounted (front plate levelness) electronic chronothermostat with backlighted display for room temperature control (heating and air-conditioning) - daily/weekly programming - switching contact output NO+NC 5A 250V~ temperature control range: from 5° C to 37° - programming set for cleaning inhibition - 4 backlighted controls - input for remote control - automatic passage to daylight saving/solar time - menu with multilingual text guide - 230V~ power supply - 50-60 Hz - 3 modules</i></p>		<p>■ 199,53 1 1</p> <p>■ 190,18</p>		