

Serie Civili **Sistema 44**

12

System 44 Wiring Accessories

Design:
S. Micheli



Indice

Index

Comandi Sistema 44 System 44 wiring accessories

NEW STYLE - ENGLAND STYLE

16

AVE TOUCH

22

WHITEK - TEKLA

36

DOMUS - CLASS - DOMUS Antibacterial

74

LIFE - ALLUMIA (RAL 9007)

126

NEW STYLE 44 ENGLAND STYLE 44

14

ILLUMINA IL TUO **STYLE**

_ LIGHT UP YOUR STYLE _

LE INNOVATIVE SERIE CIVILI DEL SISTEMA 44 AVE, NEW & ENGLAND STYLE, SONO DISPONIBILI SIA NELLA VERSIONE PER IMPIANTO ELETTRICO TRADIZIONALE CHE PER I NUOVI IMPIANTI DI ULTIMA GENERAZIONE IN VERSIONE DOMOTICA CON PROTOCOLLO PROPRIETARIO AVEBUS E CON PROTOCOLLO STANDARD INTERNAZIONALE KNX.

THE INNOVATIVE NEW AND ENGLAND STYLE WIRING ACCESSORIES SERIES OF AVE SYSTEM 44 ARE AVAILABLE BOTH FOR CONVENTIONAL ELECTRICAL SYSTEMS AND FOR THE NEW LATEST GENERATION HOME AUTOMATION SYSTEMS WITH THE PROPRIETARY AVEBUS PROTOCOL AND WITH THE INTERNATIONAL STANDARD KNX PROTOCOL.



NEW STYLE 44

CORIAN®

IMMERGITI IN UN'ATMOSFERA DI PUREZZA.
IMMERSE YOURSELF IN AN ATMOSPHERE OF PURITY.



ENGLAND STYLE 44

LEGNO / WOOD

LA RICERCA DI UNA CLASSE SENZA TEMPO.
THE SEARCH FOR A TIMELESS CLASSIC.





SERIE CIVILI
WIRING ACCESSORIES



15

Sistema 44
44 System

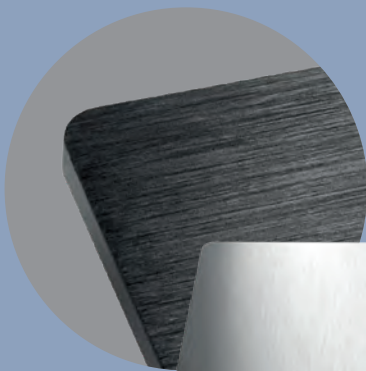

.....
NEW STYLE 44

ALLUMINIO_VETRO / ALUMINUM_GLASS

.....
DUE MATERIALI, LA DOPPIA ANIMA DEL DESIGN.
TWO MATERIALS, THE DOUBLE SOUL OF DESIGN.



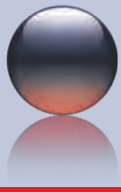

Soluzioni NEW STYLE e ENGLAND STYLE

NEW STYLE and ENGLAND STYLE Solutions



Comandi a levetta
Toggle controls

Soluzione con placche NEW STYLE vetro e placche ENGLAND STYLE legno
Solutions with glass NEW STYLE front plates and wood ENGLAND STYLE front plates

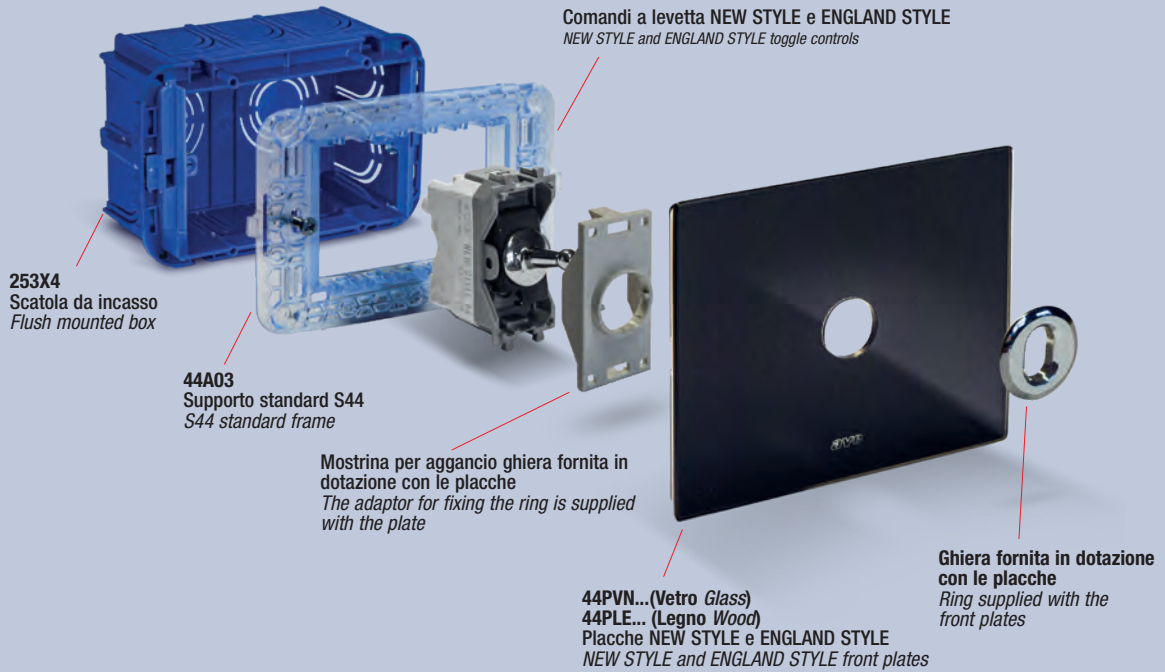

Soluzione con placche NEW STYLE Alluminio e Corian®
Solutions with aluminium NEW STYLE and Corian front plates

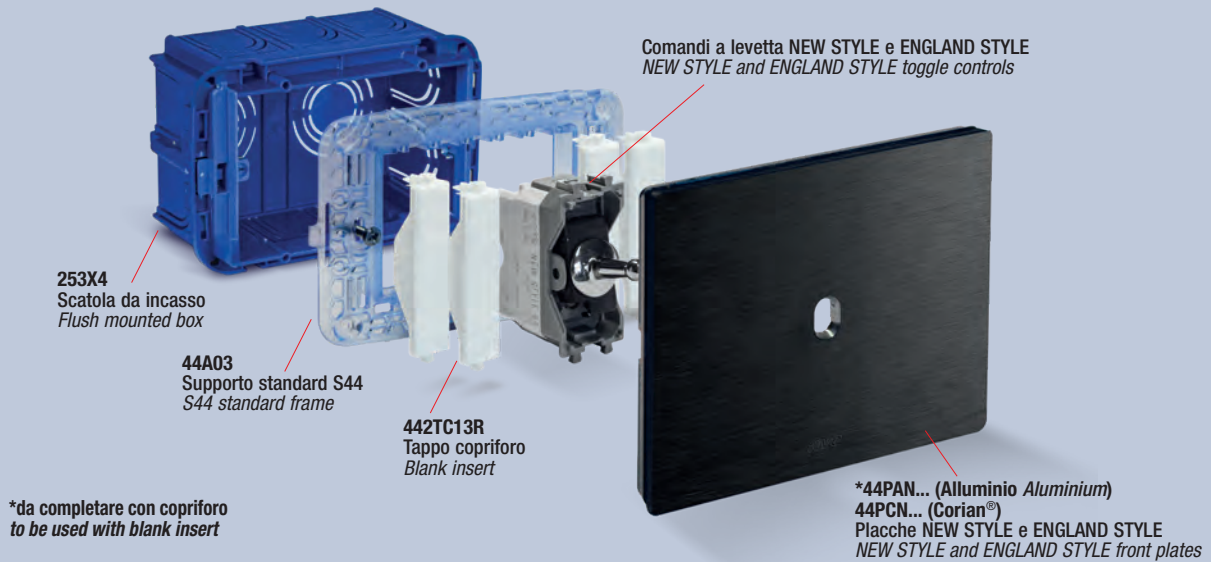

Caratteristiche Tecniche Technical Features

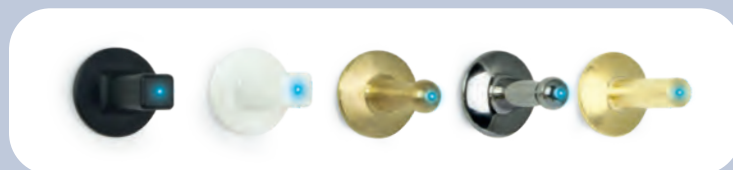

Tipologie di levette illuminabili accoppiabili alle varie placche di finitura
Types of illuminated toggle controls that can be coupled to the various finishing plates

☎ Per la disponibilità contattare la rete commerciale
For availability please contact sales dept.





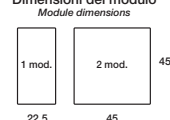

⌚ Disponibilità fino ad esaurimento scorte
Available until stock out

Prodotto per scatola rettangolare inglese
Product for British standard rectangular box

△ Prodotto per Export
For Export only









Deviatori a levetta 250V~
Toggle two-way switches 250V

 BREVETTO AVE n° 247-208
 AVE PATENT n° 247-208

Descrizione <i>Description</i>			Info	€	<input type="checkbox"/>	<input type="checkbox"/>
			444002B Deviatore a levetta 1P 10AX illuminabile - levetta colore bianco lucido - 1 modulo <i>1P 10AX lightable toggle two-way switch - toggle polished white colour - 1 module</i>	29,27	1	1
444002B	444002CR	444002GTK	444002CR Deviatore a levetta 1P 10AX illuminabile - levetta colore cromo - 1 modulo <i>1P 10AX lightable toggle two-way switch - toggle chrome colour - 1 module</i>	31,54	1	1
			444002GTK Deviatore a levetta 1P 10AX illuminabile - levetta colore grigio opaco - 1 modulo <i>1P 10AX lightable toggle two-way switch - toggle matt grey colour - 1 module</i>	 29,27	1	1
444002RO	444002OT		444002RO Deviatore a levetta 1P 10AX illuminabile - levetta colore oro - 1 modulo <i>1P 10AX lightable toggle two-way switch - toggle gold colour - 1 module</i>	 41,72	1	1
			444002OT Deviatore a levetta 1P 10AX illuminabile - levetta in ottone - 1 modulo <i>1P 10AX lightable toggle two-way switch - brass toggle - 1 module</i>	41,72	1	1

Le placche di finitura sono presenti nel capitolo dedicato: alluminio - vetro - Corian® - legno
Finishing plates are listed in the chapter Plates: aluminum - glass - Corian® - wood

Invertitore a levetta 250V~
Toggle intermediate switches 250V

Descrizione <i>Description</i>			Info	€	<input type="checkbox"/>	<input type="checkbox"/>
			444004B Invertitore a levetta 1P 10AX illuminabile - levetta colore bianco lucido - 1 modulo <i>1P 10AX lightable toggle intermediate switch - toggle polished white colour - 1 module</i>	30,80	1	1
444004B	444004CR	444004GTK	444004CR Invertitore a levetta 1P 10AX illuminabile - levetta colore cromo - 1 modulo <i>1P 10AX lightable toggle intermediate switch - toggle chrome colour - 1 module</i>	33,98	1	1
			444004GTK Invertitore a levetta 1P 10AX illuminabile - levetta colore grigio opaco - 1 modulo <i>1P 10AX lightable toggle intermediate switch - toggle matt grey colour - 1 module</i>	 30,80	1	1
444004RO	444004OT		444004RO Invertitore a levetta 1P 10AX illuminabile - levetta colore oro - 1 modulo <i>1P 10AX lightable toggle intermediate switch - toggle gold colour - 1 module</i>	 45,80	1	1
			444004OT Invertitore a levetta 1P 10AX illuminabile - levetta in ottone - 1 modulo <i>1P 10AX lightable toggle intermediate switch - brass toggle - 1 module</i>	45,80	1	1

Le placche di finitura sono presenti nel capitolo dedicato: alluminio - vetro - Corian® - legno
Finishing plates are listed in the chapter Plates: aluminum - glass - Corian® - wood











Soluzioni NEW STYLE e ENGLAND STYLE

NEW STYLE and ENGLAND STYLE Solutions









Pulsanti a levetta 250V~
Toggle push-buttons 250V

18

			Descrizione Description	Info	€	□	□
			444005B Pulsante a levetta 1P NA 10A illuminabile - levetta colore bianco lucido - 1 modulo <i>1P NO 10A lightable toggle push-button - toggle polished white colour - 1 module</i>		29,60	1	1
444005B	444005CR	444005GTK	444005CR Pulsante a levetta 1P NA 10A illuminabile - levetta colore cromo - 1 modulo <i>1P NO 10A lightable toggle push-button - toggle chrome colour - 1 module</i>		31,24	1	1
			444005GTK Pulsante a levetta 1P NA 10A illuminabile - levetta colore grigio opaco - 1 modulo <i>1P NO 10A lightable toggle push-button - toggle matt grey colour - 1 module</i>		29,60	1	1
444005ORO	444005OT		444005ORO Pulsante a levetta 1P NA 10A illuminabile - levetta colore oro - 1 modulo <i>1P NO 10A lightable toggle push-button - toggle gold colour - 1 module</i>		41,72	1	1
			444005OT Pulsante a levetta 1P NA 10A illuminabile - levetta in ottone - 1 modulo <i>1P NO 10A lightable toggle push-button - brass toggle - 1 module</i>		41,72	1	1

Le placche di finitura sono presenti nel capitolo dedicato: alluminio - vetro - Corian® - legno
Finishing plates are listed in the chapter Plates: aluminum - glass - Corian® - wood

Commutatori pulsanti a levetta 250V~
Toggle rolling blind push button 250V

			Descrizione Description	Info	€	□	□
			444053B Commutatore pulsante a levetta 1P 10A (3 morsetti) - 3 posizioni (OFF centrale) - con interblocco - levetta colore bianco lucido - 1 modulo <i>1P 10A toggle rolling blind push button (3 terminals) - 3 positions (central OFF) - with interblock - toggle polished white colour - 1 module</i>		33,46	1	1
444053B	444053CR	444053GTK	444053CR Commutatore pulsante a levetta 1P 10A (3 morsetti) - 3 posizioni (OFF centrale) - con interblocco - levetta colore cromo - 1 modulo <i>1P 10A toggle rolling blind switch (3 terminals) - 3 positions (central OFF) - with interblock - toggle chrome colour - 1 module</i>		36,63	1	1
			444053GTK Commutatore pulsante a levetta 1P 10A (3 morsetti) - 3 posizioni (OFF centrale) - con interblocco - levetta colore grigio opaco - 1 modulo <i>1P 10A toggle rolling blind switch (3 terminals) - 3 positions (central OFF) - with interblock - toggle matt grey colour - 1 module</i>		33,46	1	1
444053ORO	444053OT		444053ORO Commutatore pulsante a levetta 1P 10A (3 morsetti) - 3 posizioni (OFF centrale) - con interblocco - levetta colore oro - 1 modulo <i>1P 10A toggle rolling blind switch (3 terminals) - 3 positions (central OFF) - with interblock - gold colour - 1 module</i>		44,17	1	1
			444053OT Commutatore pulsante a levetta 1P 10A (3 morsetti) - 3 posizioni (OFF centrale) - con interblocco - levetta in ottone - 1 modulo <i>1P 10A toggle rolling blind switch (3 terminals) - 3 positions (central OFF) - with interblock - brass toggle - 1 module</i>		44,17	1	1

Le placche di finitura sono presenti nel capitolo dedicato: alluminio - vetro - Corian® - legno
Finishing plates are listed in the chapter Plates: aluminum - glass - Corian® - wood



Per la disponibilità contattare la rete commerciale
For availability please contact sales dept.



Disponibilità fino ad esaurimento scorte
Available until stock out



Prodotto per scatola rettangolare inglese
Product for British standard rectangular box



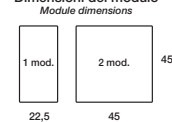

Prodotto per Export
For Export only





Commutatori a levetta 250V~ Toggle rolling blind switches 250V

BREVETTO AVE n° 247-208
AVE PATENT N° 247-208

Descrizione Description			Info	€	□	□
			444051B Commutatore a levetta 1P 10AX (3 morsetti) - 3 posizioni (OFF centrale) - con interblocco - levetta colore bianco lucido - 1 modulo <i>1P 10AX toggle rolling blind switch (3 terminals) - 3 positions (central OFF) - with interblock - toggle polished white colour - 1 module</i>	32,79	1	1
444051B	444051CR	444051OT	444051CR Commutatore a levetta 1P 10AX (3 morsetti) - 3 posizioni (OFF centrale) - con interblocco - levetta colore cromo - 1 modulo <i>1P 10AX toggle rolling blind switch (3 terminals) - 3 positions (central OFF) - with interblock - toggle chrome colour - 1 module</i>	35,90	1	1
			444051OT Commutatore a levetta 1P 10AX (3 morsetti) - 3 posizioni (OFF centrale) - con interblocco - levetta in ottone - 1 modulo <i>1P 10AX toggle rolling blind switch (3 terminals) - 3 positions (central OFF) - with interblock - brass toggle - 1 module</i>	44,63	1	1



Le placche di finitura sono presenti nel capitolo dedicato: alluminio - vetro - Corian® - legno
Finishing plates are listed in the chapter Plates: aluminum - glass - Corian® - wood

Interruttori bipolari a levetta 250V~ 2P toggle one way switches 250V

Descrizione Description			Info	€	□	□
			444010B/20A Interruttore bipolare a levetta 2P 20AX illuminabile - levetta colore bianco lucido - 1 modulo <i>2P 20AX lightable toggle one way switch - toggle polished white colour - 1 module</i>	30,22	1	1
444010B/20A	444010CR/20A	444010OT/20A	444010CR/20A Interruttore bipolare a levetta 2P 20AX illuminabile - levetta colore cromo - 1 modulo <i>2P 20AX lightable toggle one way switch - toggle chrome colour - 1 module</i>	33,45	1	1
			444010OT/20A Interruttore bipolare a levetta 2P 20AX illuminabile - levetta in ottone - 1 modulo <i>2P 20AX lightable toggle one way switch - brass toggle - 1 module</i>	45,93	1	1

Le placche di finitura sono presenti nel capitolo dedicato: alluminio - vetro - Corian® - legno
Finishing plates are listed in the chapter Plates: aluminum - glass - Corian® - wood

Dimmer universale Universal dimmer

Descrizione Description			Info	€	□	□
			444048UR Dimmer universale 3-120W, regolazione con potenziometro rotativo, fornito con 3 manopole - colore cromo, bianco e grigio opaco - 1 modulo <i>Universal dimmer 3-120W, adjustment with rotary potentiometer, supplied with 3 knobs - chrome, white and matt grey colours - 1 module</i>	 71,09	1	1

444048UR

Le placche di finitura sono presenti nel capitolo dedicato: alluminio - vetro - Corian® - legno
Finishing plates are listed in the chapter Plates: aluminum - glass - Corian® - wood

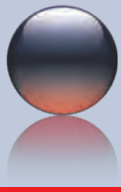

Soluzioni NEW STYLE e ENGLAND STYLE

NEW STYLE and ENGLAND STYLE Solutions



Prese di corrente
Socket outlets

Soluzione per scatola tonda con placche NEW STYLE Vetro / Alluminio e placche ENGLAND STYLE legno
Solution for round box with glass/aluminium NEW STYLE front plates and wood ENGLAND STYLE front plates

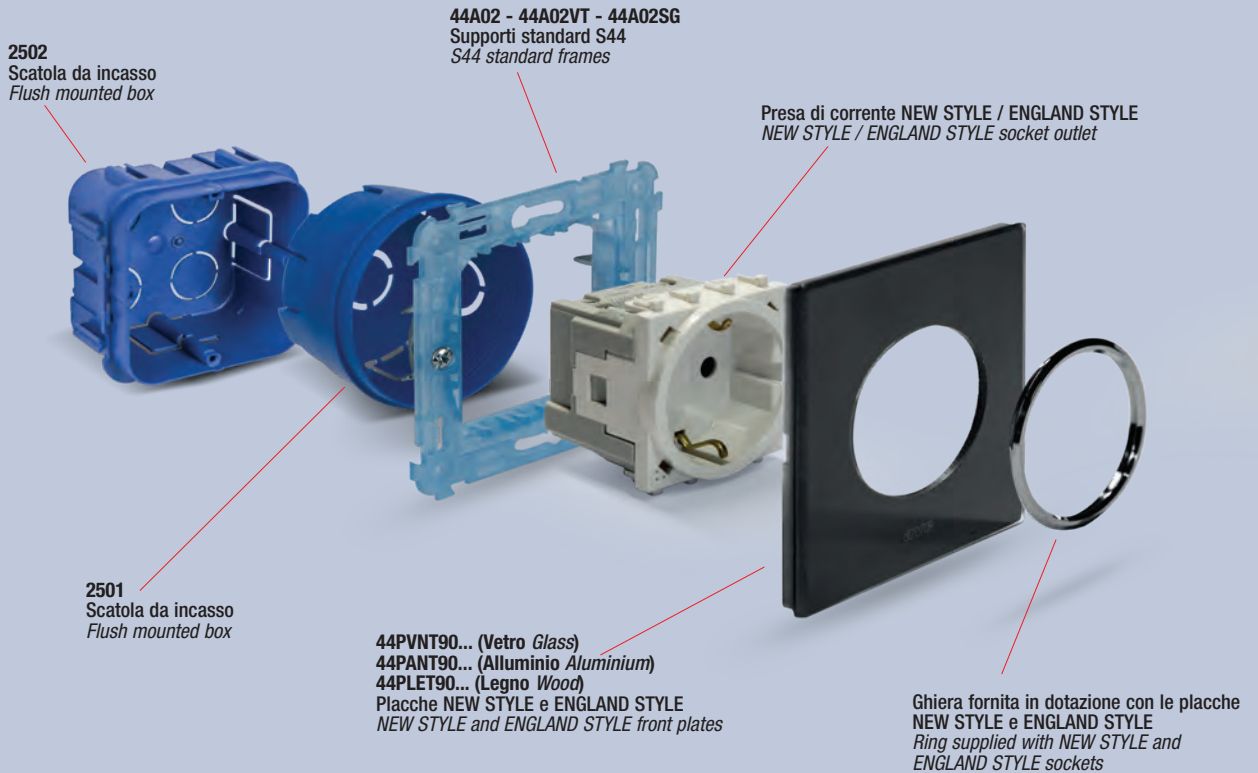

Soluzione per scatola rettangolare con placche NEW STYLE Vetro / Alluminio e placche ENGLAND STYLE legno
Solution for rectangular box with glass/aluminium NEW STYLE front plates and wood ENGLAND STYLE front plates

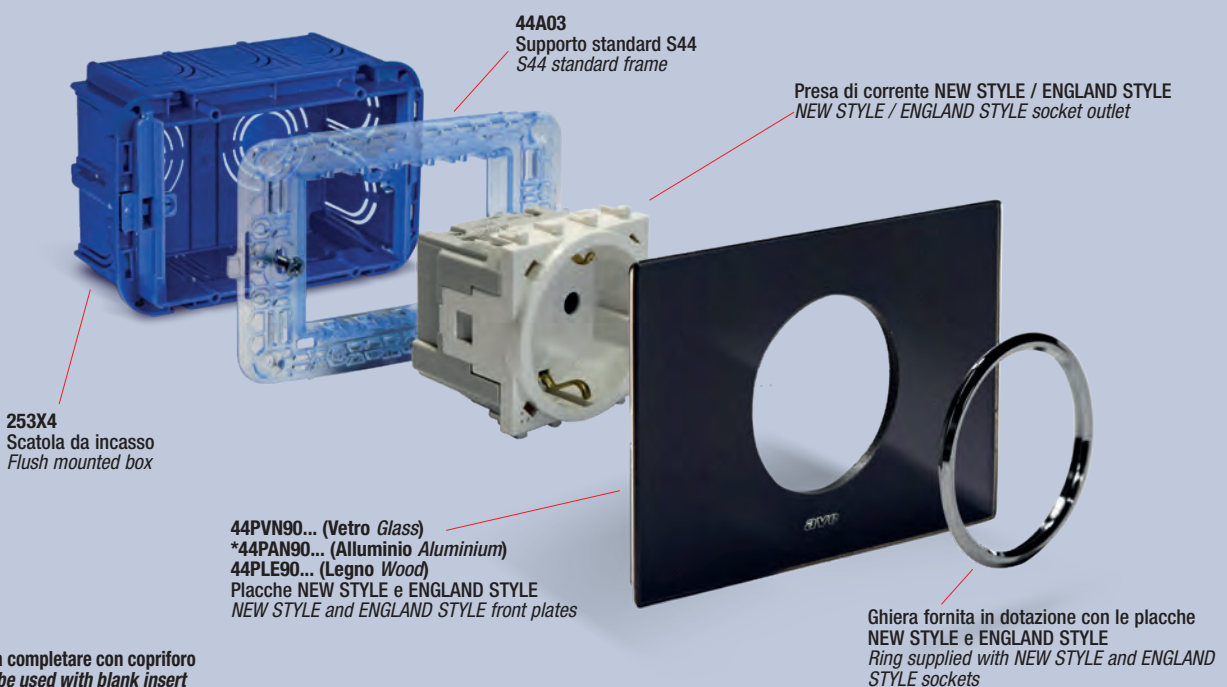

*da completare con copriforo
to be used with blank insert

Caratteristiche Tecniche Technical Features



Per la disponibilità contattare
la rete commerciale
For availability please contact
sales dept.



Disponibilità fino ad
esaurimento scorte
Available until stock out



Prodotto per scatola
rettangolare inglese
Product for British standard
rectangular box





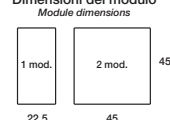

Prodotto
per Export
For Export
only







Prese di corrente P40 standard italiano 250V~
Italian standard socket outlets 250V

BREVETTO AVE n° 247-208
AVE PATENT n° 247-208

	Descrizione <i>Description</i>	Info	€	<input type="checkbox"/>	<input type="checkbox"/>	21
	444090/15TSALS Presca schuko bipasso (UNIVERSALE) 2P+T 10/16A - alveoli schermati colore Allumia - 2 moduli <i>2P+E 10/16A (UNIVERSAL) combined schuko+Italian standard socket Allumia - 2 modules</i>		38,84	1	1	
	444090/15TSB Presca schuko bipasso (UNIVERSALE) 2P+T 10/16A colore Domus - 2 moduli <i>2P+E 10/16A (UNIVERSAL) combined schuko+Italian standard socket Domus - 2 modules</i>		34,35	1	1	
	444090/15TSB Presca schuko bipasso (UNIVERSALE) 2P+T 10/16A - alveoli schermati colore Tekla - 2 moduli <i>2P+E 10/16A (UNIVERSAL) combined schuko+Italian standard socket - shuttered Tekla - 2 modules</i>		34,35	1	1	
	444090/15TSGTK Presca schuko bipasso (UNIVERSALE) 2P+T 10/16A - alveoli schermati colore Life - 2 moduli <i>2P+E 10/16A (UNIVERSAL) combined schuko+Italian standard socket Life - 2 modules</i>		38,84	1	1	
	444090/15TSNAL Placche di finitura sono presenti nel capitolo Placche: alluminio - vetro - Corian® - legno <i>Finishing plates are listed in the chapter Plates: aluminum - glass - Corian® - wood</i>					

Prese di corrente standard estero
Various standards socket outlets

	Descrizione <i>Description</i>	Info	€	<input type="checkbox"/>	<input type="checkbox"/>
	444090SALS Presca standard tedesco 2P+T 16A 250V~ - alveoli schermati colore Allumia - 2 moduli <i>2P+E 16A 250V German standard socket - shuttered Allumia - 2 modules</i>		38,84	1	1
	444090SB Presca standard tedesco 2P+T 16A 250V~ - alveoli schermati colore Domus - 2 moduli <i>2P+E 16A 250V German standard socket Domus - 2 modules</i>		34,35	1	1
	444090SB Presca standard tedesco 2P+T 16A 250V~ - alveoli schermati colore Tekla - 2 moduli <i>2P+E 16A 250V German standard socket Tekla - 2 modules</i>		34,35	1	1
	444090SGTK Presca standard tedesco 2P+T 16A 250V~ - alveoli schermati colore Life - 2 moduli <i>2P+E 16A 250V German standard socket Life - 2 modules</i>		38,84	1	1
	444090SNAL Placche di finitura sono presenti nel capitolo Placche: alluminio - vetro - Corian® - legno <i>Finishing plates are listed in the chapter Plates: aluminum - glass - Corian® - wood</i>				

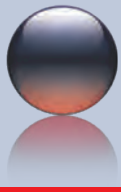

Soluzioni AVE Touch

AVE Touch Solutions



Gamma apparecchi AVE Touch
"AVE Touch" devices range

Caratteristiche Tecniche Technical Features



442TC01
Interruttore
Electronic touch switch



442TC01/2F
Interruttore statico 2 fili
Electronic touch switch 2 wires



442TC05
Pulsante
Electronic touch push button



442TC16
Comando multi-touch
Electronic multi-touch control device



442TC51
Commutatore
Electronic touch Rolling blind switch



442TC48
Dimmer
Dimmer



442TC48UL
Dimmer LED
Dimmer LED



442TC88
Pulsante con targhetta portanome
Electronic touch push button with name tag



442TC76
Segnalazione luminosa segnapasso
Light optical signal

Dimensioni d'ingombro Overall dimensions

442TC76	442TC88	442TC16	442TC01
---------	---------	---------	---------

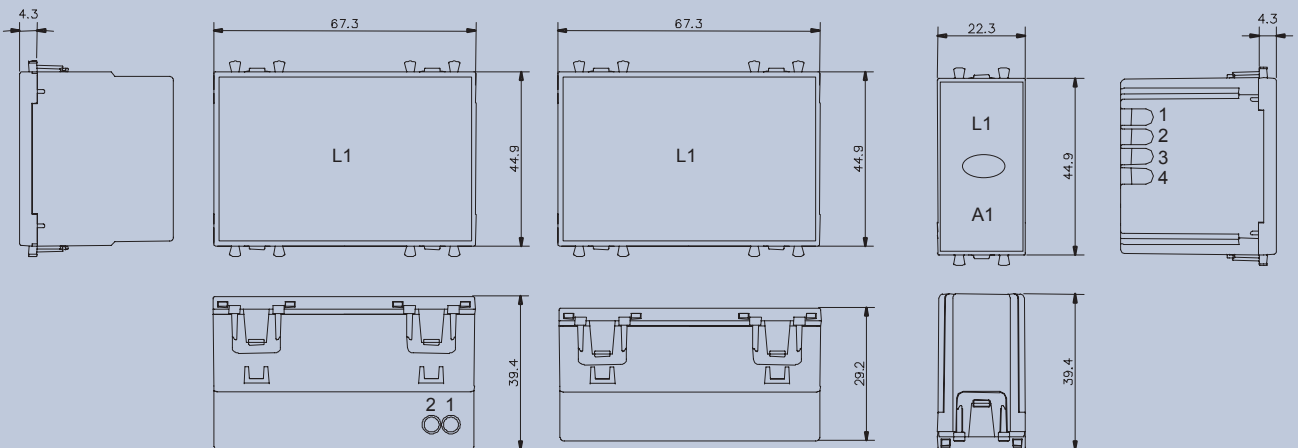

Per la disponibilità contattare la rete commerciale
For availability please contact sales dept.



Disponibilità fino ad esaurimento scorte
Available until stock out



Prodotto per scatola rettangolare inglese
Product for British standard rectangular box



Prodotto per Export
For Export only

Interruttori "a sfioramento" - installazione "a scomparsa" "Touch" switches - "hidden" installation

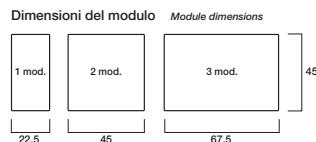

BREVETTO AVE N° 211
AVE PATENT N° 211

Descrizione Description

Info

€ □ □

23



442TC01

442TC01

Interruttore elettronico con uscita a relè 1P NA 6A 230V~ - comando mediante sfioro superficie frontale delle placche "Ave Touch" o da più punti con normali pulsanti NA - funzionamento monostabile o bistabile - led di individuazione al buio a basso consumo - memorizzazione dello stato del relè d'uscita in caso di interruzione di rete - alimentazione 230V~ - da abbinare a placche "Ave Touch" - 1 modulo "a scomparsa"

Electronic touch switch - relay output 1P NO 6A 230V~ - controlled by touching the frontal area or from multiple points with NO buttons - monostable or bistable operating mode - low consumption led for identification in the dark - output relay status memorization in case of blackout - 230V~ power supply - to be coupled with Ave "Touch" front plate - 1 "hidden" module

91,89 1 1



442TC01/2F

442TC01/2F

Interruttore elettronico 230V~ "2 fili" con uscita Triac per carichi resistivi e induttivi (lampade ad incandescenza e alogene 40-400W, trasformatori ferromagnetici per lampade alogene in bassissima tensione 40-400VA, trasformatori elettronici con comportamento induttivo  40-300VA tipo OSRAM HALOTRONIC HTM 70/230-240, HTM 105/230-240, HTM 150/230-240) - comando mediante sfioro superficie frontale delle placche "Ave Touch" o da più punti con normali pulsanti NA - funzionamento bistabile - led di individuazione al buio a basso consumo - memorizzazione dello stato dell'uscita in caso di interruzione di rete - da abbinare a placche "Ave Touch" - 1 modulo "a scomparsa"

Electronic touch switch "2 wires" 230V~ with Triac output for resistive and inductive loads (40-400W incandescent and halogen lamps, ferromagnetic transformers for low voltage 40-400 VA halogen lamps, electronic inductive transformer type  40-300VA OSRAM HALOTRONIC HTM 70/230-240, HTM 105/230-240, HTM 150/230-240) - controlled by touching the frontal area or from multiple points with NO normal buttons - bistable operating mode - low consumption led for identification in the dark - output status memorization in case of blackout - to be coupled with Ave "Touch" front plate - 1 "hidden" module

92,58 1 1

Note: ✓ 442TC01/2F: è consigliabile non installare più di un interruttore nella stessa scatola
✓ possibilità di impostazione della sensibilità di funzionamento del dispositivo: al tocco della placca o a 4 mm di distanza dalla placca stessa

Note: ✓ 442TC01/2F: it is recommended not to install more than one switch in the same box
✓ It is possible to set the sensitivity of the device: by touching the plate or at a distance of 4mm from the plate itself

Attenzione: è indispensabile rispettare la tensione di impiego indicata nelle istruzioni di prodotto.
Warning: It is mandatory to respect the operational voltage indicated on the instructions to avoid device damages

IMPORTANTE!

Sensibilità dispositivi AveTouch

Per garantire il corretto funzionamento dei dispositivi Ave Touch "a scomparsa" con la placca in alluminio è necessario impostare sui dispositivi stessi la massima sensibilità (vedi immagine riportata a lato e istruzioni allegate al prodotto, paragrafo PROGRAMMAZIONE)

IMPORTANT!

Ave Touch device sensitivity

In order to grant proper functionality of Ave Touch "hidden" devices with the aluminium plate it is necessary to set on the devices the maximum sensitivity (see instructions attached to the product, PROGRAMMING paragraph)

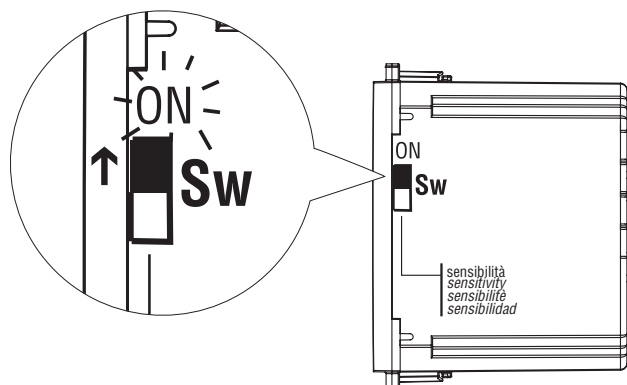

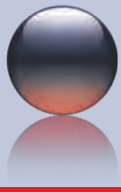

442TC01/12V

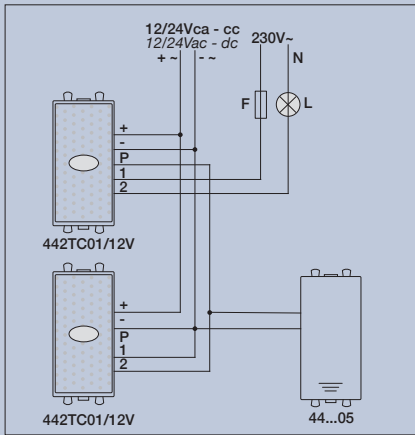

L: carico
L: load
F: fusibile tipo T 1,25A H 250V~
F: fuse type T 1,25A H 250V~

442TC01/2F

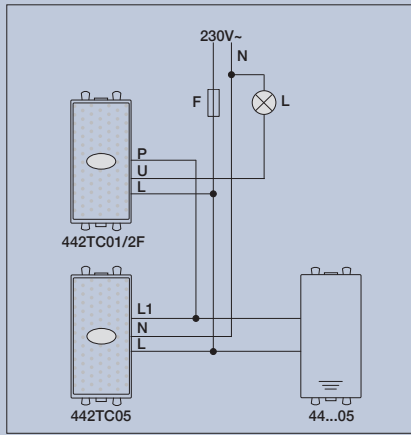

L: carico
L: load
F: fusibile tipo F 2A H 250V~
F: fuse type F 2A H 250V~

442TC01

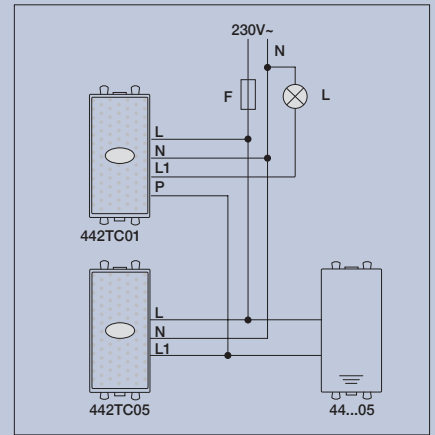

L: carico
L: load
F: fusibile tipo T 6,3A H 250V~
F: fuse type T 6,3A H 250V~

442TC05

Abbinamento a interruttore a sfioramento 442TC01 Coupled with touch switch 442TC01

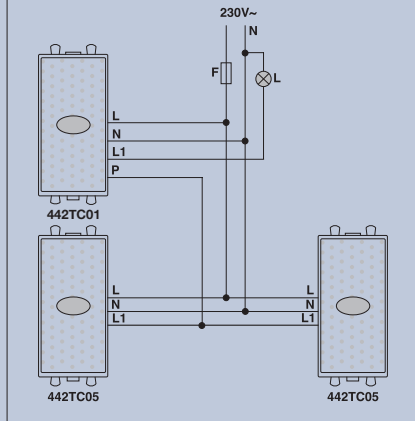

L: carico
L: load
F: fusibile tipo T 6,3A H 250V~
F: fuse type T 6,3A H 250V~

Comando diretto suonerie elettromeccaniche cod. 44..029 o ronzatori elettromeccanici cod. 44..030 Direct control of electromechanical ringing bells code 44..029 or electromechanical buzzers 44..030

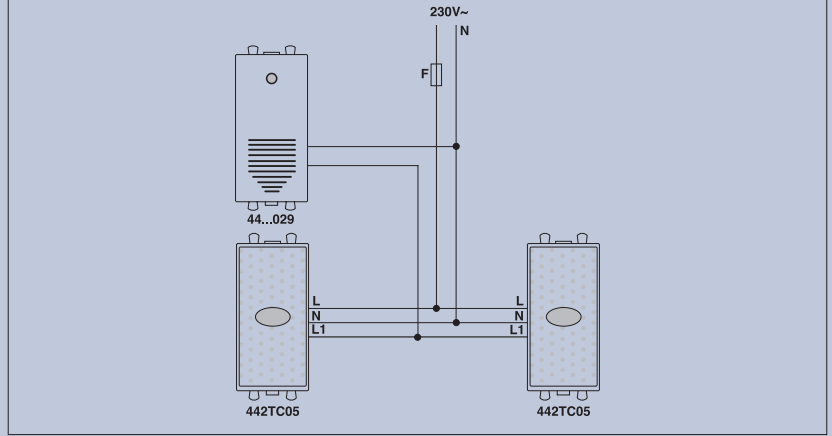

L: carico
L: load
F: fusibile F 1A H
F: fuse F 1A H

Caratteristiche Tecniche Technical Features

IMPORTANTE!
Per l'abbinamento a 442TC48UL e ai relè passo-passo a tre morsetti la fase va collegata al morsetto N ed il neutro al morsetto L

WARNING!
wired to 442TC48UL and three terminals step relays the phase should be connected to N terminal and the neutral to L terminal

Abbinamento a dimmer a sfioramento 442TC48UL Coupled with touch dimmer switch 442TC48UL

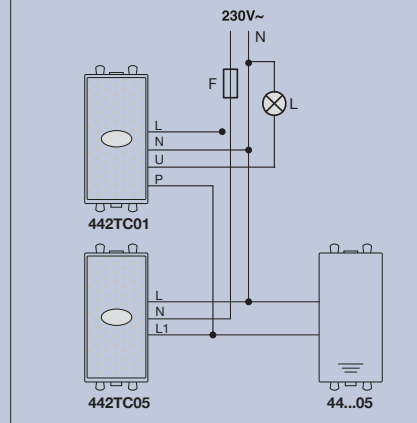

L: carico
L: load
F: fusibile F 1,6A H
F: fuse F 1,6A H

Abbinamento a relé passo-passo Combination with Step relay

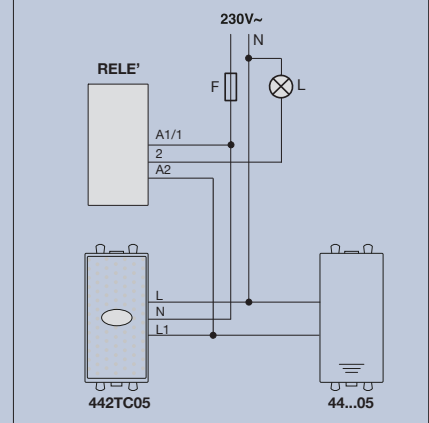

L: carico
L: load
F: fusibile F 1A H
F: fuse F 1A H

Per la disponibilità contattare la rete commerciale
For availability please contact sales dept.

Disponibilità fino ad esaurimento scorte
Available until stock out

Prodotto per scatola rettangolare inglese
Product for British standard rectangular box

△ Prodotto per Export
For Export only

Interruttori "a sfioramento" - installazione "a scomparsa" "Touch" switches - "hidden" installation

BREVETTO AVE n° 211
AVE PATENT n° 211

Descrizione Description		Info	€	□	□
 442TC01/12V	442TC01/12V Interruttore elettronico con uscita a relè 1P NA 1A 230V~ libero da potenziale - comando mediante sfioro superficie frontale delle placche "Ave Touch" o da più punti con normali pulsanti NA - funzionamento monostabile o bistabile - led di individuazione al buio a basso consumo - memorizzazione dello stato del relè d'uscita in caso di interruzione di rete - alimentazione 12÷24Vcc/ca - profondità ridotta - da abbinare a placche "Ave Touch" - 1 modulo "a scomparsa" <i>Electronic touch switch - relay output 1P NO 1A 230V~ dry contact - controlled by touching the frontal area or from multiple points with NO push buttons - monostable or bistable operating mode - low consumption led for identification in the dark - output relay status memorization in case of black out - 12÷24Vac/dc power supply - to be coupled with Ave "Touch" front plate - 1 "hidden" module</i>	92,57	1	1	
	<p>Nota: possibilità di impostazione della sensibilità di funzionamento del dispositivo: al tocco della placca o a 4 mm di distanza dalla placca stessa <i>Note: it is possible to set the sensitivity of the device: by touching the plate or at a distance of 4mm from the plate itself</i></p> <p>Attenzione: è indispensabile rispettare la tensione di impiego indicata nelle istruzioni di prodotto. In caso contrario si possono danneggiare i dispositivi <i>Warning: It is mandatory to respect the operational voltage indicated on the instructions to avoid device damages</i></p>				

25



Sistema 45

Pulsante 230V~ "a sfioramento" - installazione "a scomparsa" 230V~ "Touch" push button - "hidden" installation

Descrizione Description		Info	€	□	□
 442TC05	442TC05 Pulsante elettronico per comando remoto con sensore a sfioramento - comando mediante sfioro superficie frontale delle placche "Ave Touch" - funzionamento monostabile - led di individuazione al buio a basso consumo - alimentazione 230V~ - da abbinare a interruttore elettronico 442TC01, 442TC01/2F, 442TC16 a dimmer a sfioramento 442TC48 o 442TC48UL o a commutatore a sfioramento 442TC51 - da abbinare a placche "Ave Touch" - 1 modulo "a scomparsa" <i>Electronic push button for remote control with touch sensor - activated by touching the frontal area - monostable operating mode - low consumption led for identification in the dark - 230V~ - to be coupled with 442TC01, 442TC01/2F, 442TC48 or 442TC48UL touch dimmer - to be coupled with Ave "Touch" front plates - 1 "hidden" module</i>	93,13	1	1	
	<p>Nota: possibilità di impostazione della sensibilità di funzionamento dei dispositivi: al tocco della placca o a 4 mm di distanza dalla placca stessa <i>Note: It is possible to set the sensitivity of the device: at the touch of the plate or at a distance of 4 mm from the plate itself</i></p> <p>Attenzione: è indispensabile rispettare la tensione di impiego indicata nelle istruzioni di prodotto. In caso contrario si possono danneggiare i dispositivi <i>Warning: It is mandatory to respect the operational voltage indicated on the instructions to avoid device damages</i></p>				

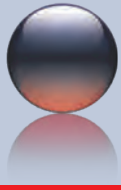

Soluzioni AVE Touch

AVE Touch Solutions

Schemi di Collegamento Connection Diagrams



Caratteristiche Tecniche Technical Features

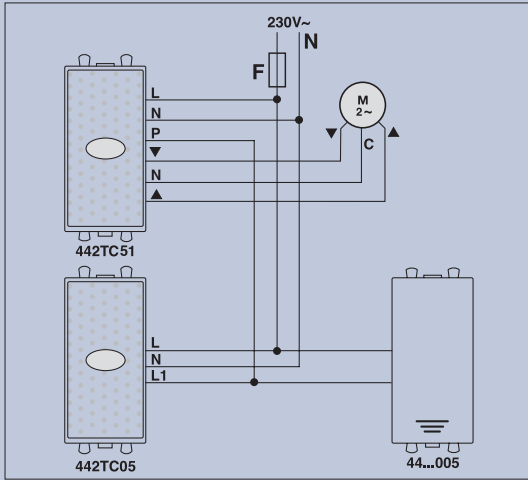

L: carico
 F: fusibile tipo F 2,5A H 250V~
 L: load
 F: fuse type F 2,5A H 250V~

442TC16

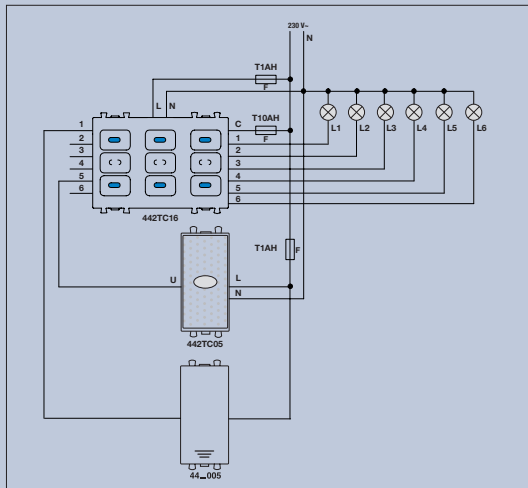

L1, L2, L3, L4, L5, L6: carico
 F: fusibile
 L1, L2, L3, L4, L5, L6: load
 F: fuse

Comando luci da due 442TC16 Light control by two pcs 442TC16

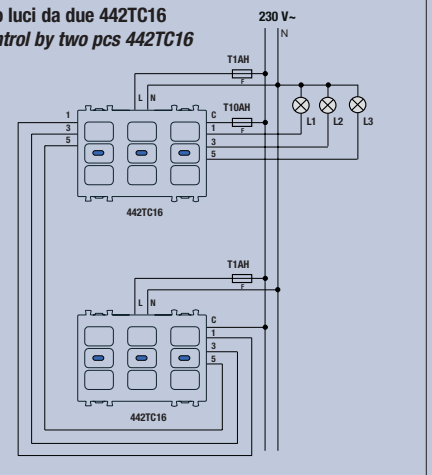

Sequenze di Installazione Installation Examples

Modulo Multi-Touch "a scomparsa" "Hidden" multi-touch module

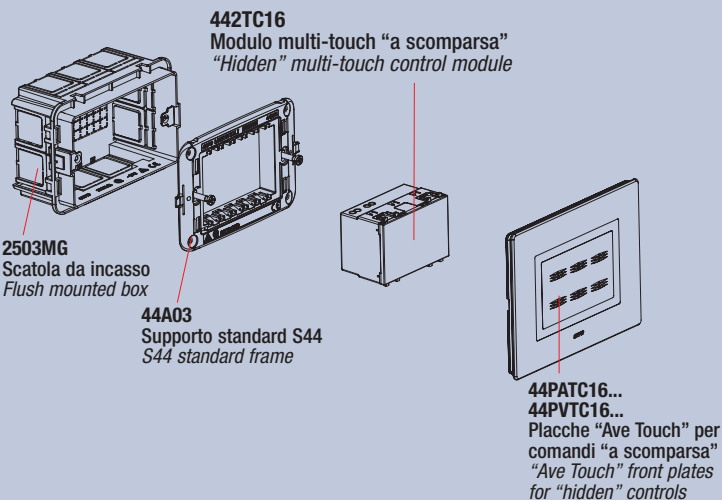

☎ Per la disponibilità contattare la rete commerciale
 For availability please contact sales dept.

⌚ Disponibilità fino ad esaurimento scorte
 Available until stock out

Prodotto per scatola rettangolare inglese
 Product for British standard rectangular box

△ Prodotto per Export
 For Export only

Commutatore 230V~ "a sfioramento" - installazione "a scomparsa" "Touch" rolling blind switch 230V - "hidden" installation

BREVETTO AVE n° 211
AVE PATENT n° 211

	Descrizione Description	Info € □ □
 <p>442TC51</p>	<p>442TC51 Commutatore elettronico con uscita a 2 relè monostabili con contatto in chiusura NA 2A 230V~ - comando mediante sfioro superficie frontale della placca in vetro o da più punti con normali pulsanti NA - funzionamento monostabile o temporizzato - led di individuazione al buio a basso consumo - alimentazione 230V~ - da abbinare a placche "Ave Touch" - 1 modulo "a scomparsa" <i>Electronic touch rolling blind switch with 2 monostable relay output, NO contact 2A 230V~ - Controlled by touching the frontal area of the glass plate or from multiple points with NO push-buttons - Monostable or bistable operating mode - Low consumption LED for identification in the dark - 230V~ power supply - to be coupled with AVE "Touch" front plates - 1 "hidden" module</i></p> <p>Nota: possibilità di impostazione della sensibilità di funzionamento dei dispositivi: al tocco della placca o a 4 mm di distanza dalla placca stessa <i>Note: It is possible to set the sensitivity of the device: at the touch of the plate or at a distance of 4 mm from the plate itself</i></p> <p>Attenzione: è indispensabile rispettare la tensione di impiego indicata nelle istruzioni di prodotto. In caso contrario si possono danneggiare i dispositivi <i>Warning: It is mandatory to respect the operational voltage indicated on the instructions to avoid device damages</i></p>	<p>114,02 1 1</p>



Comandi multi-touch "a sfioramento" - installazione "a scomparsa" "Multi-Touch" control devices - for "hidden" installation

	Descrizione Description	Info € □ □
 <p>442TC16</p>	<p>442TC16 Comando elettronico multi-touch con 6 uscite a relè monostabili con contatto in chiusura 1P NA 2A 230V~ libero da potenziale - comando mediante sfioro superficie frontale delle placche "Ave Touch" o da più punti con normali pulsanti NA - funzionamento uscite: monostabili, bistabili o temporizzate, tapparelle (con interblocco funzionale) - n° 9 led frontali (di cui solo massimo 6 contemporaneamente accesi) di individuazione al buio a basso consumo - memorizzazione dello stato dei relè d'uscita in caso di interruzione di rete - alimentazione 100÷240V~ 50-60 Hz - da abbinare a placche "Ave Touch" - 3 moduli "a scomparsa" <i>Electronic multi-touch control device - 6 monostable output-relay front 1P NO contact 2A 230V~ Dry contact - controlled by touching the frontal area of the finishing plate or from multiple points with NO push-buttons - monostable, bistable or timed operating modalities, curtains with interlock - n. 9 low consumption front led for identification in the darkness (only 6 led switched on at the same time - saving output-relay status in case of blackout - power supply 100÷240 Vac/dc ~ 50-60 HZ - to be coupled with Ave "Touch" front plate - 3 "hidden" modules.</i></p> <p>Nota: possibilità di impostazione della sensibilità di funzionamento del dispositivo: al tocco della placca o a 4 mm di distanza dalla placca stessa <i>Note: It is possible to set the sensitivity of the device: by touching the plate or at a distance of 4mm from the plate itself</i></p> <p>Attenzione: è indispensabile rispettare la tensione di impiego indicata nelle istruzioni di prodotto. In caso contrario si possono danneggiare i dispositivi <i>Warning: It is mandatory to respect the operational voltage indicated on the instructions to avoid device damages</i></p>	<p>278,27 1 1</p>

Segnalazione ottica - installazione "a scomparsa" Optical signal - "hidden" installation

BREVETTO INVENZIONE INDUSTRIALE AVE n° 243
AVE INDUSTRIAL INVENTION PATENT n° 243

	Descrizione Description	Info € □ □
 <p>442TC76</p>	<p>442TC76 Segnalazione luminosa/illuminazione segnapasso personalizzabile - possibilità personalizzazione a mezzo di pellicole intercambiabili con scritte e simbologie varie scelte dall'utente - alimentazione 230V~ - possibilità regolazione intensità luminosa dell'area per pellicole personalizzabili - utilizzabile per uso segnapasso, luce di cortesia, ecc. - da abbinare all'apposita placca "Ave Touch" - 3 moduli "a scomparsa" <i>Customizable light signal/optical signal - possibility to customize it with interchangeable labels with writings and symbols chosen by the user - 230V~ power supply - possibility to regulate the light intensity in the area for customized label - it can be used as stair riser light, courtesy light, etc.. - to be coupled with the proper "Ave Touch" front plate - 3 "hidden" modules</i></p> <p>Nota: fornita con n° 2 pellicole texture optical diverse <i>Note: supplied with 2 different optical texture films</i></p>	<p>133,84 1 1</p>

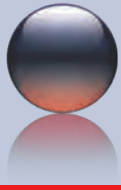

Caratteristiche Tecniche Technical Features

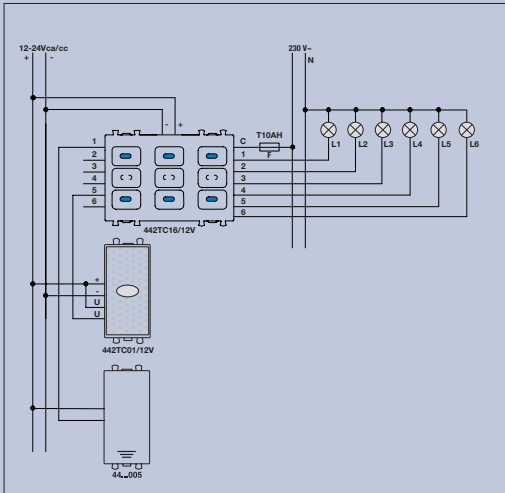

L1, L2, L3, L4, L5, L6: carico
F: fusibile
L1, L2, L3, L4, L5, L6: load
F: fuse

Comando luci da due 442TC16/12V Light control by two pcs 442TC16/12V

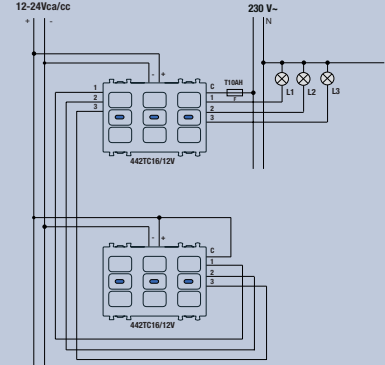

442TC48

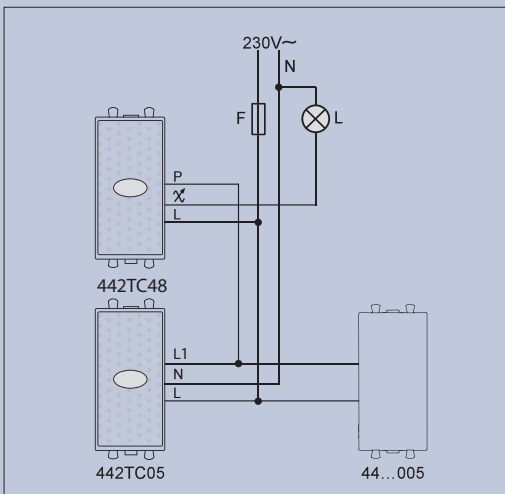

L: carico
F: fusibile tipo F 2A H 250V~
L: load
F: fuse type F 2A H 250V~

Sequenze di Installazione Installation Examples

Comandi "a scomparsa" "Hidden" devices

2503MG
Scatola da incasso
Flush mounted box

44A03
Supporto standard S44
S44 standard frame

442TC13...
Tappi copriforo "a scomparsa"
"Hidden" devices

44PATC...
44PVTC0...
Placche "Ave Touch" per
comandi "a scomparsa"
"Ave Touch" front plates
for "hidden" controls

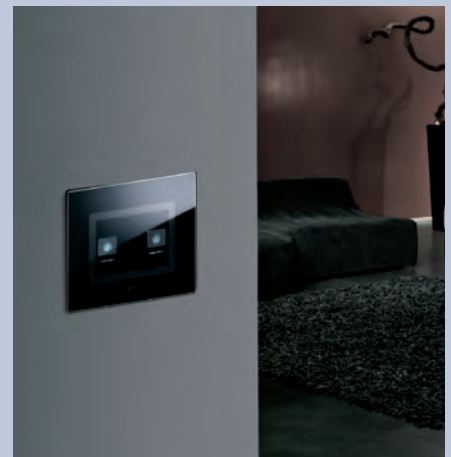

☎ Per la disponibilità contattare
la rete commerciale
For availability please contact
sales dept.

⌚ Disponibilità fino ad
esaurimento scorte
Available until stock out

Prodotto per scatola
rettangolare inglese
Product for British standard
rectangular box

△ Prodotto
per Export
For Export
only

Comandi multi-touch "a sfioramento" - installazione "a scomparsa"

"Multi-Touch" control devices - for "hidden" installation

BREVETTO AVE n° 211
AVE PATENT n° 211

29



442TC16/12V

Descrizione Description

Info

€ □ □

442TC16/12V

275,42 1 1

Comando elettronico multi-touch con 6 uscite a relè monostabili con contatto in chiusura 1P NA 2A 230V~ libero da potenziale - comando mediante sfioro superficie frontale delle placche "Ave Touch" o da più punti con normali pulsanti NA - funzionamento uscite: monostabili, bistabili o temporizzate, tapparelle (con interblocco funzionale) - n° 9 led frontali (di cui solo massimo 6 contemporaneamente accesi) di individuazione al buio a basso consumo - memorizzazione dello stato dei relè d'uscita in caso di interruzione di rete - alimentazione 12÷24Vcc/ca~ 50-60 Hz - profondità ridotta - da abbinare a placche "Ave Touch" - 3 moduli "a scomparsa"

Electronic multi-touch control device - 6 monostable output-relay front 1P NO contact 2A 230V~ Dry contact - controlled by touching the frontal area of the finishing plate or from multiple points with NO push-buttons - monostable, bistable or timed operating modalities, curtains with interlock - n. 9 low consumption front led for identification in the darkness (only 6 led switched on at the same time - saving output-relay status in case of blackout - power supply 12÷24 Vac/dc ~ 50-60 HZ - to be coupled with Ave "Touch" front plate - 3 "hidden" modules.

Nota: possibilità di impostazione della sensibilità di funzionamento del dispositivo: al tocco della placca o a 4 mm di distanza dalla placca stessa

Note: it is possible to set the sensitivity of the device: by touching the plate or at a distance of 4mm from the plate itself

Attenzione: è indispensabile rispettare la tensione di impiego indicata nelle istruzioni di prodotto.

Warning: It is mandatory to respect the operational voltage indicated on the instructions to avoid device damages



Sistema 45

Dimmer per regolazione luci 230V~ "a sfioramento" - installazione "a scomparsa"

230V~ "Touch" dimmer for lighting controls - "hidden" installation



442TC48

Descrizione Description

Info

€ □ □

442TC48

127,73 1 1

Regolatore di luminosità 230V~ per carichi resistivi e induttivi (lampade ad incandescenza e alogene 40-400W, trasformatori ferromagnetici per lampade alogene in bassissima tensione 40-400VA, trasformatori elettronici con comportamento induttivo 40-300VA tipo OSRAM HALOTRONIC HTM 70/230-240, HTM 105/230-240, HTM 150/230-240) - comando e regolazione mediante sfioro superficie frontale delle placche "Ave Touch" o da più punti con normali pulsanti NA - led di individuazione al buio a basso consumo - memorizzazione dello stato e del livello dell'uscita in caso d'interruzione di rete - da abbinare a placche "Ave Touch" - 1 modulo "a scomparsa"

230V~ dimmer for resistive and inductive loads (40-400W incandescent and halogen lamps, ferromagnetic transformers for low voltage 40-400 VA halogen lamps, electronic inductive transformer type 40-300VA OSRAM HALOTRONIC HTM 70/230-240, HTM 105/230-240, HTM 150/230-240) - control and regulation by touching the frontal area of front plates or from multiple points with normal NO push-buttons - low consumption led for identification in the dark - output and level relay status memorization in case of blackout - to be coupled with "Ave Touch" front plates - 1 "hidden" module

Note: ✓ è consigliabile non installare più di un regolatore nella stessa scatola
✓ possibilità di impostazione della sensibilità di funzionamento del dispositivo: al tocco della placca o a 4 mm di distanza dalla placca stessa

Note: ✓ it is recommended not to install more than one dimmer in the same box
✓ It is possible to set the sensitivity of the device: by touching the plate or at a distance of 4mm from the plate itself

Attenzione: è indispensabile rispettare la tensione di impiego indicata nelle istruzioni di prodotto.

Warning: It is mandatory to respect the operational voltage indicated on the instructions to avoid device damages

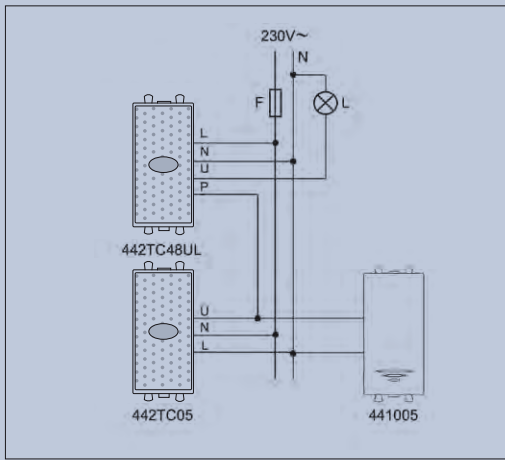
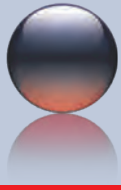

L: carico
F: fusibile tipo F 1,6A H 250V~
L: load
F: fuse type F 1,6A H 250V~

Sistemi di chiamata 230 Vca
esempio: suoneria 44...029
Call systems 230 Vac
ringing bell example 44...029

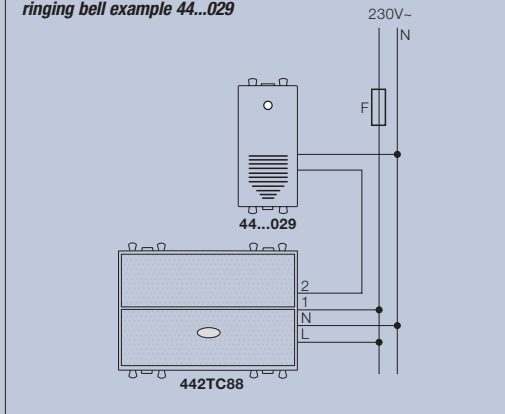

F: fusibile tipo F 1A H 250V~
F: fuse type F 1A H 250V~

Sistemi di chiamata 12 Vca
esempio: suoneria tritonale 44...083
Call systems 12 Vac
three tone bell example 44...083

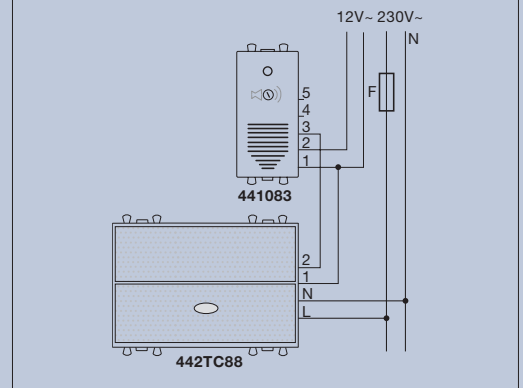

F: fusibile tipo F 1A H 250V~
F: fuse type F 1A H 250V~

Sequenze di Installazione Installation Examples

Modulo Pulsante con Targhetta Portanome "a scomparsa" "Hidden" push button with name tag

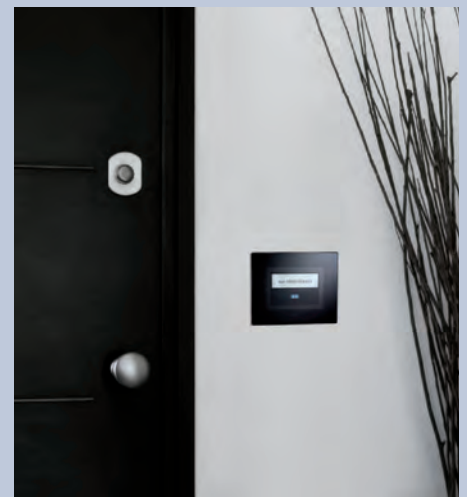
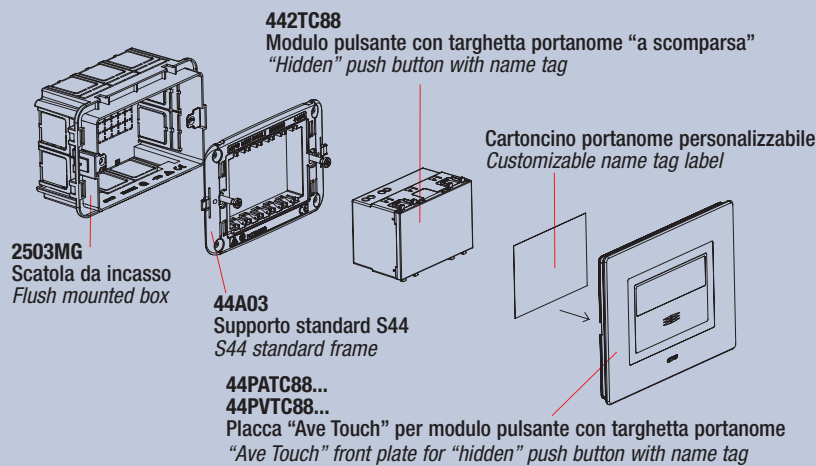

Per la disponibilità contattare la rete commerciale
For availability please contact sales dept.

Disponibilità fino ad esaurimento scorte
Available until stock out

Prodotto per scatola rettangolare inglese
Product for British standard rectangular box

△ Prodotto per Export
For Export only

Dimmer universale per regolazione luci 230V~ "a sfioramento" - installazione "a scomparsa"

230V~ universal "Touch" dimmer for lighting controls - "hidden" installation

BREVETTO AVE n° 211
AVE PATENT n° 211

31



442TC48UL

Descrizione Description

Info

€ □ □

442TC48UL

134,19 1 1

Regolatore di luminosità 230V~ per carichi resistivi e induttivi (lampade ad incandescenza e alogene 3-220W, trasformatori elettronici 20-220VA, lampade LED 3-120W, lampade CFL 3-220W - alimentatori elettronici LED a taglio di fase) - comando e regolazione mediante sfioro superficie frontale delle placche "Ave Touch" o da più punti con normali pulsanti NA - led di individuazione al buio a basso consumo - memorizzazione dello stato e del livello dell'uscita in caso d'interruzione di rete - da abbinare a placche "Ave Touch" - 1 modulo "a scomparsa"

230V~ dimmer for resistive and inductive loads (3-220W incandescent and halogen lamps, ferromagnetic transformers 20-220VA, LED lamps 3-120W, CFL lamps 3-220W - electronic ballasts for LED with line interruption) - control and regulation by touching the front of the plate "Ave Touch" or from push-buttons NO - low consumption led for identification in the dark - output and level relay status memorization in case of blackout - to be coupled with "Ave Touch" front plates - 1 "hidden" module

Note: ✓ è consigliabile non installare più di un regolatore nella stessa scatola
✓ possibilità di impostazione della sensibilità di funzionamento del dispositivo: al tocco della placca o a 4 mm di distanza dalla placca stessa

Note: ✓ it is recommended not to install more than one dimmer in the same box
✓ it is possible to set the sensitivity of the device: by touching the plate or at a distance of 4mm from the plate itself

Pulsante campanello 230V~ "a sfioramento" - installazione "a scomparsa"

230V~ "Touch" bell push button - "hidden" installation



442TC88

Descrizione Description

Info

€ □ □

442TC88

140,12 1 1

Pulsante elettronico con targhetta portanome personalizzabile - uscita a relè 1P NA 8A - comando mediante sfioro superficie frontale delle placche "Ave Touch" - funzionamento monostabile - led di individuazione al buio - alimentazione 230V~ - possibilità regolazione intensità luminosa area per targhetta portanome - buzzer (escludibile) per conferma chiamata - da abbinare all'apposita placca "Ave Touch" - 3 moduli "a scomparsa"

Electronic push-button with customizable name tag - relay output 1P NO 8A - controlled by touching the frontal area of front plate - monostable operating mode - low consumption led for identification in the dark - 230V~ power supply - possibility to regulate the light intensity of the name tag area - buzzer (that can be excluded) for call confirmation - to be coupled with "Ave Touch" front Plates - 3 "hidden" modules

Nota: possibilità di impostazione della sensibilità di funzionamento del dispositivo: al tocco della placca o a 4 mm di distanza dalla placca stessa

Note: It is possible to set the sensitivity of the device: by touching the plate or at a distance of 4mm from the plate itself

Attenzione: è indispensabile rispettare la tensione di impiego indicata nelle istruzioni di prodotto. In caso contrario si possono danneggiare i dispositivi

Warning: It is mandatory to respect the operational voltage indicated on the instructions to avoid device damages

Copriforo - installazione "a scomparsa" Blank insert - "hidden" installation

BREVETTO AVE n° 211
AVE PATENT n° 211



442TC13R



442TC13A

Descrizione Description

Info

€ □ □

442TC13R

3,23 12 72

Tappo copriforo - da abbinare a placche "Ave Touch" - 1/2 modulo
Blank insert - to be coupled with "Ave Touch" front plates - 1/2 module

442TC13A

3,33 10 60

Tappo copriforo attrezzabile - predisposizione per aggancio a involucro vuoto - da abbinare a placche "Ave Touch" - 1 modulo
Equippable blank insert - preset for clipping it to empty box - to be coupled with "Ave Touch" front plates - 1 module

442TC13A/3

6,02 10 10

Tappo copriforo attrezzabile - fornito con involucro vuoto - da abbinare a placche "Ave Touch" - 3 moduli
Equippable blank insert - supplied with empty box - to be coupled with "Ave Touch" front plates - 3 modules



442TC13A/3

Nota: a richiesta potrà essere fornito l'involucro per l'aggancio al tappo copriforo 442TC13A
Note: the 1 module box for the 442TC13A blank insert clipping can be supplied upon request

Le dimensioni, salvo diversamente specificato, sono in mm
Dimensions, except where otherwise specified, are in mm

□ Imballo Minimo pcs
Min. Packaging pcs

□ Imballo Standard pcs
Std. Packaging pcs

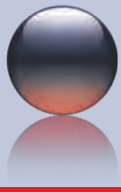

Soluzioni AVE Touch

AVE Touch Solutions



SFM3/HP Scatola per pareti tradizionali (forato rosso)
SFM3/HP Box for brickwork walls

SFM3CG/HP Scatola per pareti in cartongesso
SFM3CG/HP Box for hollow walls

Caratteristiche Tecniche Technical Features

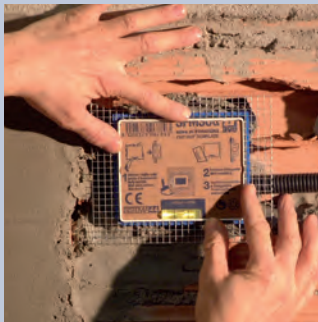

1 Realizzare la spaccatura e, con la malta, fissare la scatola orizzontalmente avvalendosi dell'apposita livella a bolla fornita in dotazione
Make the hole and use the spirit level to fix the box



1 Applicare la dima alla parete e, sfruttando la livella a bolla, segnare la traccia
Use the spirit level to fix the template then trace the line



2 Applicare la malta grezza
Apply the mortar

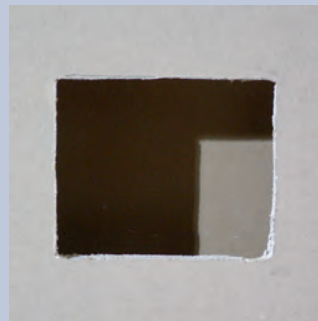

2 Realizzare foro
Make the hole



3 Effettuare la finitura
Make the finishing touches

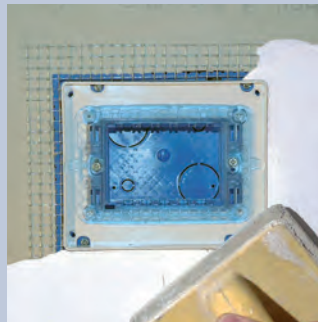

3 Inserire la scatola, fissarla alla parete e poi effettuare la rasatura della stessa
After installing the box, smooth the wall



4 Tinteggiare la parete
Paint the wall



4 Tinteggiare la parete
Paint the wall

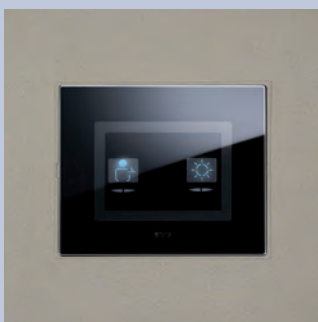

5 Applicare la placca di finitura
Effetto finale "filo muro senza cornice"
*Place the finishing front plate
Final effect "wall-lined without adapter frame"*

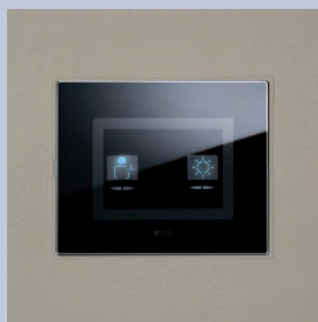

5 Applicare la placca di finitura
Effetto finale "filo muro senza cornice"
*Place the finishing front plate
Final effect "wall-lined without adapter frame"*

☎ Per la disponibilità contattare la rete commerciale
For availability please contact sales dept.

🕒 Disponibilità fino ad esaurimento scorte
Available until stock out

Prodotto per scatola rettangolare inglese
Product for British standard rectangular box

△ Prodotto per Export
For Export only

Scatole speciali per installazioni filo muro totale - installazione di precisione

Special boxes for high precision completely wall-lined installation

BREVETTO AVE N° 209
MODELLO COMUNITARIO
AVE PATENT N° 209

33

Descrizione Description

Info

€ □ □



SFM3/HP

SFM3/HP

Scatola 3 moduli per pareti in muratura - interasse viti 83,5 mm - fornita con paramalta e livella a bolla (applicati alla scatola) e cornice completa di supporto 3 moduli sistema 44

3 modules box for brickwork walls - screw fixing centre 83,5 mm - supplied with cardboard mortarproof, spirit level (attached to the box) and System 44 3 modules frame

37,51 1 1

SFM3CG/HP

Scatola 3 moduli per pareti in cartongesso - interasse viti 83,5 mm - fornita con dima di foratura, livella a bolla e cornice completa di supporto 3 moduli sistema 44

3 modules box for hollow walls - screw fixing centre 83,5 mm - supplied with template, spirit level and System 44 3 modules frame

44,09 1 1

Nota: l'insieme scatola + placca "Ave Touch" garantisce un grado di protezione IP44

Note: the box with the "Ave Touch" front plate guarantees an IP44 protection degree



SFM3CG/HP

Dimensioni d'ingombro Overall dimensions

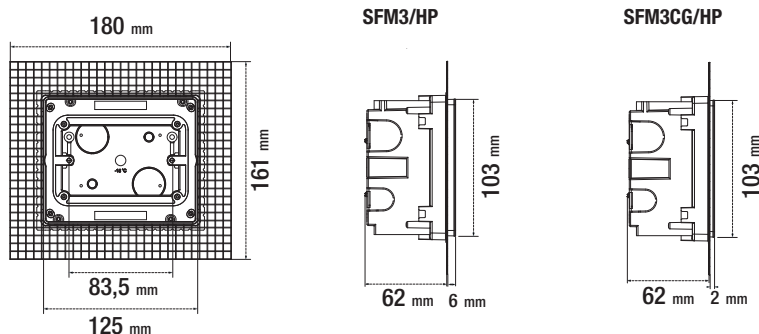

Ave Touch anche a Filo Muro Wall-lined Ave Touch

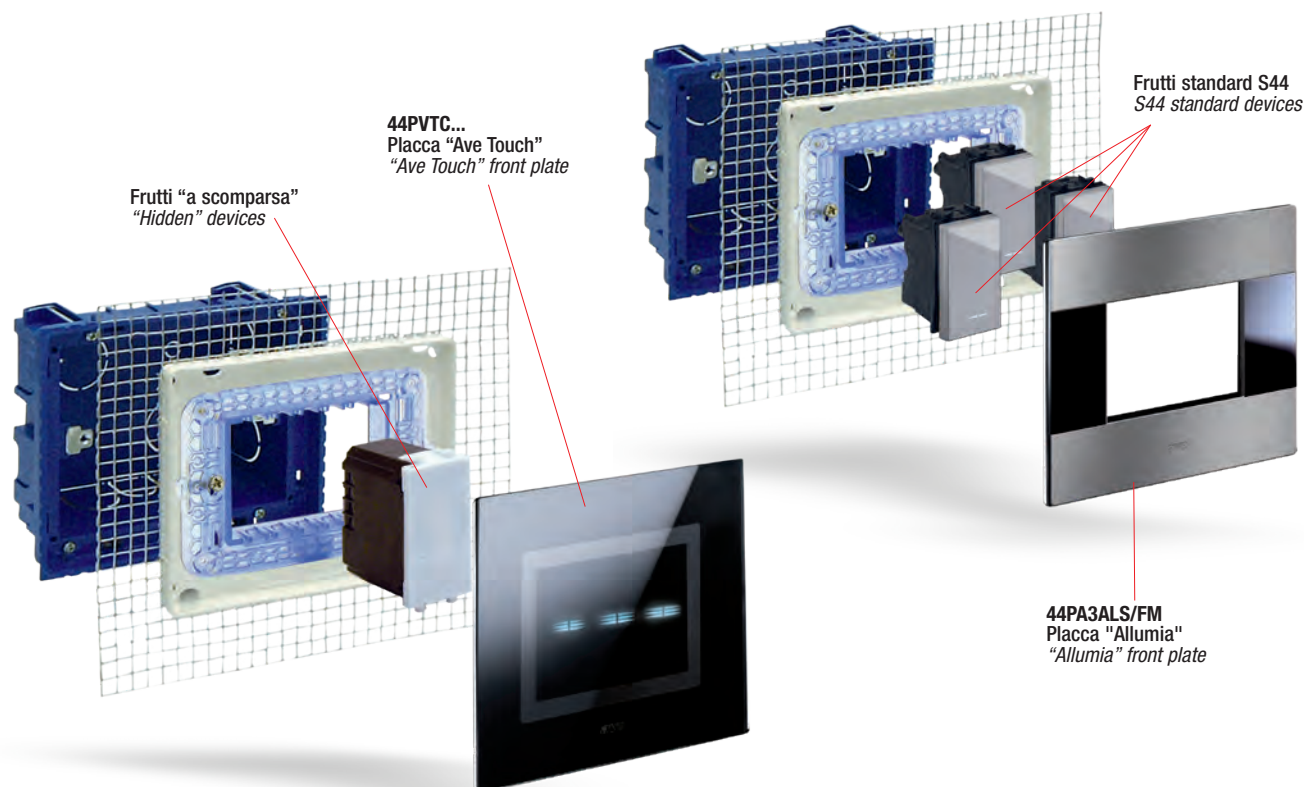

Le dimensioni, salvo diversamente specificato, sono in mm
Dimensions, except where otherwise specified, are in mm

□ Imballo Minimo pcs
Min. Packaging pcs

□ Imballo Standard pcs
Std. Packaging pcs