





WHITETEK<sup>44</sup>



TEKLA<sup>44</sup>



Domus<sup>100</sup>



CLASS<sup>44</sup>

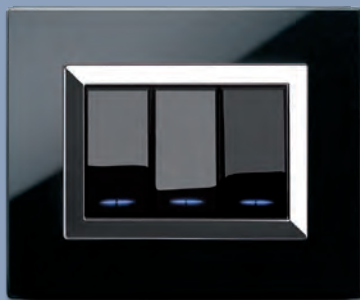

LIFE<sup>44</sup>



ALLUMIA

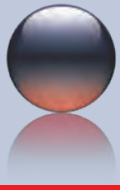

# Serie WHITEK - TEKLA

WHITEK - TEKLA series

Assiali  
Axial

Dimensione del modulo

Module dimension

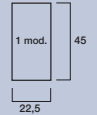

**Serie Whitek**  
colore RAL 9010  
finitura OPACO

color RAL 9010  
MATT finish



**Serie Tekla**  
colore RAL 7016  
finitura OPACO

color RAL 7016  
MATT finish

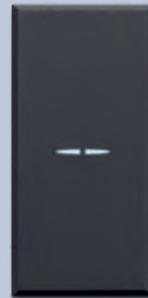

Caratteristiche Tecniche Technical Features

### Comandi assiali

con i comandi assiali di nuova generazione è possibile attivare il carico premendo qualsiasi punto della superficie dei tasti. Una volta premuti ritornano in posizione restando sempre perfettamente allineati alla placca di finitura.

### Axial switches

by using the new generation axial controls it is possible to activate the load by pressing any point on the surface of the keys. Once pressed they return to position, always remaining perfectly aligned with the front plate.

Superficie del comando completamente chiusa per ridurre al minimo l'ingresso della polvere  
Fully enclosed control surface to minimize dust ingress

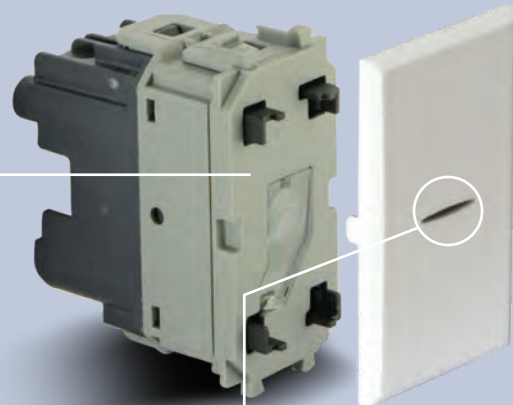
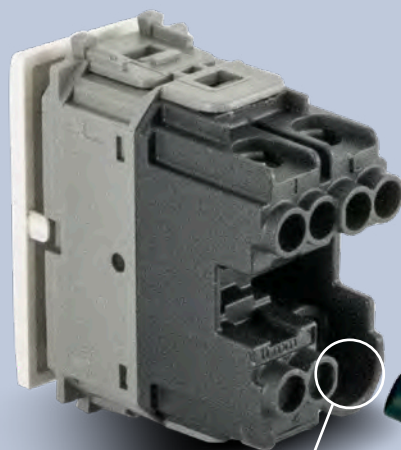

Consigliato l'utilizzo di lampada a led colore blu (cod. 0230LDB)  
It is recommended the use of blue colour led lamp (code 0230LDB)

Inserimento lampadina di segnalazione  
Lamp insertion



Per la disponibilità contattare la rete commerciale  
For availability please contact sales dept.



Disponibilità fino ad esaurimento scorte  
Available until stock out



Prodotto per scatola rettangolare inglese  
Product for British standard rectangular box



Prodotto per Export  
For Export only



## Corpo Comando Assiali 250V~ Axial switches 250V~

Tekla			Descrizione Description	Info	€	□	□
			<b>□ 445001STAS</b> Corpo interruttore assiale per tasti Tekla, Whitek e Allumia, 1P 10AX illuminabile-1 mod. <i>Axial switch body for Tekla, Whitek and Allumia rocker, 1P 10AX lightable - 1 mod.</i>		8,95	10	100
445001STAS	445002STAS	445005STAS	<b>□ 445002STAS</b> Corpo deviatore assiale per tasti Tekla, Whitek e Allumia, 1P 10AX illuminabile-1 mod. <i>Axial two way switch body for Tekla, Whitek and Allumia rocker, 1P 10AX lightable - 1 mod.</i>		10,54	10	100
			<b>□ 445005STAS</b> Corpo pulsante assiale per tasti Tekla, Whitek e Allumia, 1P 10A illuminabile-1 mod. <i>Axial pushbutton body for Tekla, Whitek and Allumia rocker, 1P 10A lightable - 1 mod.</i>		10,57	10	100
<b>Nota:</b> forniti senza lampada di segnalazione <b>Note:</b> supplied without lamp							

## Comandi Assiali Axial switches

Whitek	Tekla	Descrizione Description	Info	€	□	□
		<b>□ 446001AS</b> ■ <b>445001AS</b> Interruttore assiale con gemma, 1P 10AX illuminabile - 1 mod. <i>Axial switch with gem, 1P 10AX lightable - 1 mod.</i>		9,13	10	100
446001AS 446010AS	445001AS 445010AS	<b>□ 446010AS</b> ■ <b>445010AS</b> Interruttore bipolare assiale con gemma, 2P 10AX illuminabile - 1 mod. <i>Axial bipolar switch with gem, 2P 10AX lightable - 1 mod.</i>		22,37	10	100
		<b>□ 446002AS</b> ■ <b>445002AS</b> Deviatore assiale con gemma, 1P 10AX illuminabile - 1 mod. <i>Axial two way switch with gem, 1P 10AX lightable - 1 mod.</i>		10,92	10	100
446002AS	445002AS	<b>□ 446004AS</b> ■ <b>445004AS</b> Invertitore assiale con gemma, 1P 10AX illuminabile - 1 mod. <i>Axial intermediate switch with gem, 1P 10AX lightable - 1 mod.</i>		22,37	10	100
		<b>□ 446005AS</b> ■ <b>445005AS</b> Pulsante assiale con gemma, 1P 10A illuminabile -1 mod. <i>Axial push-button with gem, 1P 10A illuminated - 1 mod.</i>		11,10	10	100
446004AS	445004AS	<b>Nota:</b> forniti senza lampada di segnalazione <b>Note:</b> supplied without lamp				
446005AS	445005AS					

## Tasti intercambiabili assiali Interchangeable rockers axial

Whitek	Tekla	Descrizione Description	Info	€	□	□
		<b>□ 446TAS</b> ■ <b>445TAS</b> Tasto intercambiabile con gemma per comandi assiali - 1 mod. <i>Interchangeable rocker with gem for axial controls - 1 mod.</i>		2,58	5	5
446TKPAS	446TMCAS	<b>□ 446TKPAS</b> ■ <b>445TKPAS</b> Tasto intercambiabile con simbolo chiave per comandi assiali - 1 mod. <i>Interchangeable rocker with key symbol for axial controls - 1 mod.</i>		3,52	5	5
		<b>□ 446TLPAS</b> ■ <b>445TLPAS</b> Tasto intercambiabile con simbolo lampada per comandi assiali - 1 mod. <i>Interchangeable rocker with lamp symbol for axial controls - 1 mod.</i>		3,52	5	5
446TLPAS	445TLPAS	<b>□ 446TSPAS</b> ■ <b>445TSPAS</b> Tasto intercambiabile con simbolo suoneria per comandi assiali - 1 mod. <i>Interchangeable rocker with ringtone symbol for axial commands - 1 mod.</i>		3,52	5	5
		<b>□ 446TMCAS</b> Tasto intercambiabile con gemma ovale per comandi assiali - 1 mod. <i>Interchangeable rocker with oval gem for axial commands - 1 mod.</i>		5,68	5	5
446TSPAS	445TSPAS					



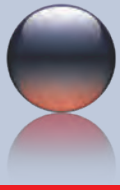

# Serie WHITEK - TEKLA

WHITEK - TEKLA series

Interruttori 250V~

One way switches 250V~

Dimensioni del modulo Module dimensions

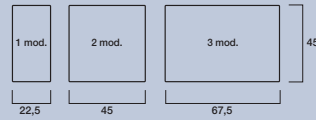

Caratteristiche Tecniche Technical Features

**Serie Whitek**  
colore RAL 9010  
finitura OPACO

color RAL 9010  
MATT finish



**Serie Tekla**  
colore RAL 7016  
finitura OPACO

color RAL 7016  
MATT finish



### Cacciaviti per comandi e prese di corrente *Screwdrivers for control devices and socket outlets*

Indicazioni per l'utilizzo di cacciaviti appropriati:

- tutti i prodotti elettromeccanici (interruttori, prese, supporti) sono dotati di viti con testa a croce che possono essere fissate con avvitatori automatici e manuali intaglio a croce PHILLIPS dimensione 2 e cacciavite a lama con larghezza max 5 mm e spessore max 0,8 mm.
- il momento torcente massimo non deve superare 1,8 Nm.

Information on use of suitable screwdrivers:

- all electromechanical products (switches, sockets and supports) are equipped with crosshead screws which can be fixed by automatic PHILLIPS screwdrivers size 2 and manual crosshead screwdrivers with max width 5 mm and max thickness 0,8 mm.
- maximum torque must not exceed 1.8 Nm

### Illuminazione Comandi *Controls Lighting*

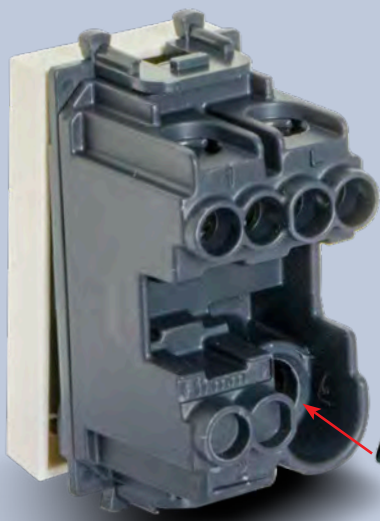

Inserimento lampadina di segnalazione  
Lamp insertion

Consigliato l'utilizzo di lampada a led colore blu (cod. 0230LDB)

It is recommended the use of blue color led lamp (code 0230LDB)



Per la disponibilità contattare la rete commerciale  
For availability please contact sales dept.



Disponibilità fino ad esaurimento scorte  
Available until stock out



Prodotto per scatola rettangolare inglese  
Product for British standard rectangular box



Prodotto per Export  
For Export only

Interruttori 250V~  
One way switches 250V~

Whitek	Tekla	Descrizione Description	Info	€	□	□
		<p>■ <b>445001ST</b> Corpo interruttore 1P 16AX illuminabile da completare con tasto Tekla o Whitek1 o 2 moduli - 1 modulo <i>1P 16AX one way lightable switch mechanism to be completed with Tekla or Whitek1 or 2 mod. rocker - 1 mod.</i></p>		<b>8,13</b>	10	100
	445001ST	<p>□ <b>446001</b> ■ <b>445001</b> Interruttore 1P 16AX illuminabile - tasto intercambiabile - 1 modulo <i>1P 16AX one way lightable switch - interchangeable rocker - 1 module</i></p>		<b>4,03</b>	10	100
		<p>□ <b>446001/10A</b> ■ <b>445001/10A</b> Interruttore 1P 10AX illuminabile - tasto intercambiabile - 1 modulo <i>1P 10AX one way lightable switch - interchangeable rocker - 1 module</i></p>		<b>3,74</b>	10	100
446001 446001/20A	445001 445001/20A	<p>□ <b>446001/20A</b> ■ <b>445001/20A</b> Interruttore 1P 20AX illuminabile - tasto intercambiabile - 1 modulo <i>1P 20AX one way lightable switch - interchangeable rocker - 1 module</i></p>		<b>7,31</b>	10	100
		<p>□ <b>446001/2</b> ■ <b>445001/2</b> Interruttore 1P 16AX a tasto largo illuminabile - tasto intercambiabile - 2 moduli <i>1P 16AX one way lightable large switch - interchangeable rocker - 2 modules</i></p>		<b>7,86</b>	5	50
		<p>□ <b>446010</b> ■ <b>445010</b> Interruttore 2P 16AX illuminabile - tasto intercambiabile - 1 modulo <i>2P 16AX one way lightable switch - interchangeable rocker - 1 module</i></p>		<b>14,42</b>	10	100
446001/2	445001/2	<p>□ <b>446010SL</b> ■ <b>445010SL</b> Interruttore 2P 16AX con gemma ad alta visibilità - tasto intercambiabile - 1 modulo <i>2P 16AX one way lightable switch - interchangeable rocker - 1 module</i></p>		<b>15,98</b>	10	100
		<p>□ <b>446010/20A</b> ■ <b>445010/20A</b> Interruttore bipolare 2P 20AX illuminabile - tasto intercambiabile - 1 modulo <i>2P 20AX one way lightable switch - interchangeable rocker - 1 module</i></p>		<b>17,41</b>	1	1
446010 446010/20A	445010 445010/20A	<p>□ <b>446010/2</b> ■ <b>445010/2</b> Interruttore 2P 16AX a tasto largo illuminabile - tasto intercambiabile - 2 moduli <i>2P 16AX one way lightable large switch - interchangeable rocker - 2 modules</i></p>		<b>18,15</b>	1	1
		<p>■ <b>445010LV/20A</b> Interruttore bipolare a levetta 2P 20AX illuminabile - 1 modulo <i>2P 20AX lightable toggle one way switch - 1 module</i></p>		<b>29,27</b>	1	1
		<p>■ <b>442010RS/20A</b> Interruttore 2P 20AX illuminabile - rosso - 1 modulo <i>2P 20AX one way lightable switch - red - 1 module</i></p>		<b>16,15</b>	1	10
446010SL	445010SL					
	445010LV/20A					
	442010RS/20A					

**Nota:** forniti senza lampada di segnalazione  
*Note:* supplied without lamp

Sistema 45



# Serie WHITEK - TEKLA

WHITEK - TEKLA series



Deviatori 250V~  
Two way switches 250V~

40

Whitek

Tekla

Descrizione *Description*

Info

€

□

□



446002



446002/2



446002K3/10A



445002ST



445002



445002/2



445002K3/10A



445002LV

■ **445002ST**  
Corpo deviatore 1P 16AX illuminabile da completare con tasto Tekla o Whitek 1 o 2 moduli - 1 modulo  
*1P 16AX two way lightable switch mechanism to be completed with Tekla or Whitek 1 or 2 modules rocker - 1 module*



9,92

10

100

□ **446002** ■ **445002**  
Deviatore 1P 16AX illuminabile - tasto intercambiabile - 1 modulo  
*1P 16AX two way lightable switch - interchangeable rocker - 1 module*

5,37

10

100

□ **446002/10A** ■ **445002/10A**  
Deviatore 1P 10AX illuminabile - tasto intercambiabile - 1 modulo  
*1P 10AX two way lightable smooth switch - interchangeable rocker - 1 module*



5,02

10

100

□ **446002/2** ■ **445002/2**  
Deviatore 1P 16AX a tasto largo illuminabile - tasto intercambiabile - 2 moduli  
*1P 16AX two way lightable large switch - interchangeable rocker - 2 modules*

9,11

5

50

□ **446002K3/10A** ■ **445002K3/10A**  
Triplo deviatore 1P 10AX - n° 3 tasti indipendenti - 2 moduli  
*1P 10AX triple two way switch - 3 independent rockers - 2 modules*



16,36

5

5

■ **445002LV**  
Deviatore a levetta 1P 10AX illuminabile - 1 modulo  
*1P 10AX toggle two-way switch - lightable - 1 module*

27,50

1

1

**Nota: forniti senza lampada di segnalazione**  
**Note: supplied without lamp**



Per la disponibilità contattare la rete commerciale  
For availability please contact sales dept.



Disponibilità fino ad esaurimento scorte  
Available until stock out



Prodotto per scatola rettangolare inglese  
Product for British standard rectangular box



Prodotto per Export  
For Export only



## Invertitori 250V~ Intermediate switches 250V~

Whitek	Tekla	Descrizione Description	Info	€	□	□
		<input type="checkbox"/> 446004 <input checked="" type="checkbox"/> 445004 Invertitore 1P 16AX illuminabile - tasto intercambiabile - 1 modulo <i>1P 16AX lightable intermediate switch - interchangeable rocker - 1 module</i>		17,59	10	100
446004	445004	<input type="checkbox"/> 446004/10A <input checked="" type="checkbox"/> 445004/10A Invertitore 1P 10AX illuminabile - tasto intercambiabile - 1 modulo <i>1P 10AX intermediate lightable switch - interchangeable rocker - 1 module</i>		16,98	10	100
		<input type="checkbox"/> 446004/2 <input checked="" type="checkbox"/> 445004/2 Invertitore 1P 16AX a tasto largo illuminabile - tasto intercambiabile - 2 moduli <i>1P 16AX lightable large intermediate switch - interchangeable rocker - 2 modules</i>		20,37	5	50
446004/2	445004/2	<input checked="" type="checkbox"/> 445004LV Invertitore a levetta 1P 10AX illuminabile - 1 modulo <i>1P 10AX toggle two-way switch - lightable - 1 module</i>		30,97	1	1
	445004LV					

**Nota:** forniti senza lampada di segnalazione  
*Note:* supplied without lamp

41

Sistema 45

## Tasti intercambiabili per Interruttori, Deviatori, Invertitori e Assiali Interchangeable rockers for one way switch, two way switch, intermediate switch and axial

Whitek	Tekla	Descrizione Description	Info	€	□	□
		<input type="checkbox"/> 446T <input checked="" type="checkbox"/> 445T Tasto intercambiabile liscio illuminabile - 1 modulo <i>Interchangeable smooth lightable rocker - 1 module</i>		1,41	14	14
446T	445T	<input type="checkbox"/> 446T/2 <input checked="" type="checkbox"/> 445T/2 Tasto intercambiabile liscio illuminabile - 2 moduli <i>Interchangeable smooth lightable rocker - 2 modules</i>		3,18	2	2
		<input type="checkbox"/> 446TGP <input checked="" type="checkbox"/> 445TGP Tasto intercambiabile con gemma illuminabile - diffusore visibile anche di giorno - 1 modulo <i>Interchangeable rocker with lightable lens - diffuser visible even in daylight - 1 module</i>		2,67	14	14
446T/2	445T/2	<input type="checkbox"/> 446TSL <input checked="" type="checkbox"/> 445TSL Tasto intercambiabile con gemma ad alta visibilità - 1 modulo <i>Interchangeable button with high visibility gem - 1 module</i>		3,03	5	5
446TG	445TGP					
446TSL	445TSL					

Le dimensioni, salvo diversamente specificato, sono in mm  
Dimensions, except where otherwise specified, are in mm

Imballo Minimo pcs  
Min. Packaging pcs

Imballo Standard pcs  
Std. Packaging pcs



# Serie WHITEK - TEKLA

## WHITEK - TEKLA series

Pulsanti 250V~  
Push-buttons 250V~



42

Whitek

Tekla

Descrizione *Description*

Info

€



445005ST

■ **445005ST**  
Corpo pulsante 1P NA 10A illuminabile da completare con tasto Tekla o Whitek  
1 o 2 moduli - 1 modulo  
*1P NO 10A lightable push-button mechanism to be completed with Tekla o Whitek  
1 or 2 mod rocker - 1 module*



8,50 10 100

□ **446005** ■ **445005**  
Pulsante 1P NA 10A illuminabile - tasto intercambiabile - 1 modulo  
*1P NO 10A lightable push-button - interchangeable rocker - 1 module*

5,43 10 100



446005  
446025



445005  
445025

□ **446005/2** ■ **445005/2**  
Pulsante 1P NA 10A a tasto largo illuminabile - tasto intercambiabile - 2 moduli  
*1P NO 10A large lightable push-button - interchangeable rocker - 2 modules*

8,60 5 50

□ **446025** ■ **445025**  
Pulsante 1P NA+NC 10A illuminabile - tasto intercambiabile - 1 modulo  
*1P NO+NC 10A lightable push-button - interchangeable rocker - 1 module*

9,63 10 10



446005/2



445005/2

□ **446050** ■ **445050**  
Pulsante 1P NA 10A 250V con spia di segnalazione illuminabile - diffusore  
trasparente - fornito con etichette di personalizzazione - 1 modulo  
*1P NO 10A 250V - lightable push-button - transparent diffuser - supplied with  
customization labels - 1 module*

17,05 1 10

□ **446056** ■ **445056**  
Doppio pulsante 1P NA + 1P NA 10A senza interblocco: è consentita la chiusura  
contemporanea dei 2 circuiti - 1 modulo  
*1P NO + 1P NO 10A double push-button - lightable - without interblock:  
the simultaneous closure of the 2 circuits is allowed - 1 module*

16,63 1 10



446050



445050

□ **446005SL** ■ **445005SL**  
Pulsante 1P NA 10A con gemma ad alta visibilità - 1 modulo  
*1P NO 10A high visibility push-button with gem - 1 module*



8,64 10 100

■ **445005LV**  
Pulsante a levetta 1P NA 10A illuminabile - 1 modulo  
*1P NO 10A toggle push-button - lightable - 1 module*

26,98 1 1



446056



445056

**Note:** ✓ gli articoli illuminabili sono forniti senza lampada di segnalazione  
✓ 44...056 consentendo la chiusura contemporanea di due circuiti non sono adatti  
all'inversione di marcia di motori (es. tapparelle, ecc.)

**Notes:** ✓ *lightable articles are supplied without lamp*  
✓ *Since 44...056 allow the simultaneous closure of two circuits, they are not  
suitable for motor reversing (ex. rolling shutter, ecc.)*



446005SL



445005SL



445005LV



Per la disponibilità contattare  
la rete commerciale  
For availability please contact  
sales dept.



Disponibilità fino ad  
esaurimento scorte  
Available until stock out



Prodotto per scatola  
rettangolare inglese  
Product for British standard  
rectangular box



Prodotto  
per Export  
For Export  
only

Pulsanti 250V~  
Push-buttons 250V~

Whitek	Tekla	Descrizione Description	Info	€	□	□
		<b>□ 446056F</b> <b>■ 445056F</b> Doppio pulsante 1P NA + 1P NA 10A con frecce direzionali - senza interblocco: è consentita la chiusura contemporanea dei 2 circuiti - 1 modulo <i>1P NO + 1P NO 10A double push-button with arrows - without interblock :            the simultaneous closure of the 2 circuits is allowed - 1 module</i>		16,62	1	10
446056F	445056F	<b>□ 446017</b> <b>■ 445017</b> Pulsante 1P NA+NC 10A a tirante - cordone in materiale isolante 1,5 m - 1 modulo <i>1P NO+NC 10A cord operated push-button - insulating material cord 1,5 m - 1 module</i>		16,85	1	10
		<b>□ 441005TP/2</b> Pulsante 1P NA 10A con targhetta portanome retroilluminabile - illuminazione a mezzo lampada con attacco E10 10x28 mm tipo T10 1,5W max ad incandescenza o led - fornito con lampada - fornito con cartoncino portanome personalizzabile - 2 moduli <i>1P NO 10A push-button with lightable name tag - illumination by incandescent or led lamp E10 10x28 mm T10 1,5W max type - supplied with customizable name tag card - supplied with lamp - 2 modules</i>		21,40	1	6
		<b>■ 442005TP/2</b> Pulsante 1P NA 10A con targhetta portanome retroilluminabile - illuminazione a mezzo lampada con attacco E10 10x28 mm tipo T10 1,5W max ad incandescenza o led - fornito con lampada - fornito con cartoncino portanome personalizzabile - 2 moduli <i>1P NO 10A push-button with lightable name tag - illumination by incandescent or led lamp E10 10x28 mm T10 1,5W max type - supplied with customizable name tag card - supplied with lamp - 2 modules</i>		28,92	1	6
		<b>■ 442025RS/2</b> Pulsante di emergenza 1P NA+NC 10A a tasto largo illuminabile - rosso - 2 moduli <i>1P NO+NC 10A large emergency push-button - red - 2 modules</i>		16,13	1	6
441005TP/2	442005TP/2	<b>Note:</b> ✓ gli articoli illuminabili sono forniti senza lampada di segnalazione ✓ 44..056F consentendo la chiusura contemporanea di due circuiti non sono adatti all'inversione di marcia di motori (es. tapparelle, ecc.) <b>Notes:</b> ✓ lightable articles are supplied without lamp ✓ Since 44..056F allow the simultaneous closure of two circuits, they are not suitable for motor reversing (ex. rolling shutter, ecc.)				



442025RS/2

Pulsante con targhetta portanome Push button with name tag

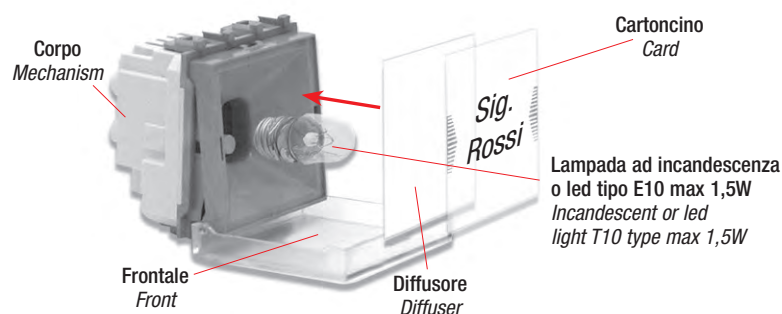

Montaggio lampada e cartoncino  
Lamp and card assembly



Sistema 45























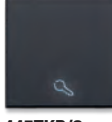

# Serie WHITEK - TEKLA

WHITEK - TEKLA series



Tasti intercambiabili per pulsanti  
Interchangeable rockers for push buttons

44

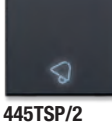
Whitek	Tekla	Descrizione Description	Info	€	□	□
 446T	 445T	<input type="checkbox"/> 446T <input checked="" type="checkbox"/> 445T Tasto intercambiabile liscio illuminabile - 1 modulo <i>Interchangeable smooth lighttable rocker - 1 module</i>		1,41	14	14
 446T/2	 445T/2	<input type="checkbox"/> 446T/2 <input checked="" type="checkbox"/> 445T/2 Tasto intercambiabile liscio illuminabile - 2 moduli <i>Interchangeable smooth lighttable rocker - 2 modules</i>		3,18	2	2
 446TGP	 445TGP	<input type="checkbox"/> 446TGP <input checked="" type="checkbox"/> 445TGP Tasto intercambiabile con gemma illuminabile - diffusore visibile anche di giorno - 1 modulo <i>Interchangeable rocker with lighttable lens - diffuser visible even in daylight - 1 module</i>		2,67	14	14
 446TGP/2	 445TGP/2	<input type="checkbox"/> 446TGP/2 <input checked="" type="checkbox"/> 445TGP/2 Tasto intercambiabile con gemma illuminabile - diffusore visibile anche di giorno - 2 moduli <i>Interchangeable rocker with lighttable lens - diffuser visible even in daylight - 2 modules</i>		4,52	2	2
 446TKP	 445TKP	<input type="checkbox"/> 446TKP <input checked="" type="checkbox"/> 445TKP Tasto intercambiabile con simbolo CHIAVE illuminabile - 1 modulo <i>Interchangeable rocker with lighttable KEY symbol - 1 module</i>		2,52	14	14
 446TKP/2	 445TKP/2	<input type="checkbox"/> 446TKP/2 <input checked="" type="checkbox"/> 445TKP/2 Tasto intercambiabile con simbolo CHIAVE illuminabile - 2 moduli <i>Interchangeable rocker with lighttable KEY symbol - 2 modules</i>		3,91	2	2
 446TLP	 445TLP	<input type="checkbox"/> 446TLP <input checked="" type="checkbox"/> 445TLP Tasto intercambiabile con simbolo LAMPADA illuminabile - 1 modulo <i>Interchangeable rocker with lighttable LAMP symbol - 1 module</i>		2,52	14	14
 446TLP/2	 445TLP/2	<input type="checkbox"/> 446TLP/2 <input checked="" type="checkbox"/> 445TLP/2 Tasto intercambiabile con simbolo LAMPADA illuminabile - 2 moduli <i>Interchangeable rocker with lighttable LAMP symbol - 2 modules</i>		3,91	2	2
 446TSL	 445TSL	<input type="checkbox"/> 446TSL <input checked="" type="checkbox"/> 445TSL Tasto intercambiabile con gemma ad alta visibilità - 1 modulo <i>Interchangeable button with high visibility gem - 1 module</i>		3,03	5	5
 446TSP	 445TSP	<input type="checkbox"/> 446TSP <input checked="" type="checkbox"/> 445TSP Tasto intercambiabile con simbolo SUONERIA illuminabile - 1 modulo <i>Interchangeable rocker with lighttable BELL symbol - 1 module</i>		2,52	14	14
 446TSP/2	 445TSP/2	<input type="checkbox"/> 446TSP/2 <input checked="" type="checkbox"/> 445TSP/2 Tasto intercambiabile con simbolo SUONERIA illuminabile - 2 moduli <i>Interchangeable rocker with lighttable BELL symbol - 2 modules</i>		3,91	2	2



Per la disponibilità contattare la rete commerciale  
For availability please contact sales dept.



Disponibilità fino ad esaurimento scorte  
Available until stock out



Prodotto per scatola rettangolare inglese  
Product for British standard rectangular box



Prodotto per Export  
For Export only

## Tasti intercambiabili per pulsanti

### Interchangeable rockers for push buttons

Whitek	Tekla	Descrizione Description	Info	€	□	□
		<b>□ 446TBP</b> ■ 445TBP Tasto intercambiabile con simbolo BOILER illuminabile - 1 modulo <i>Interchangeable rocker with lightable BOILER symbol - 1 module</i>		2,60	14	14
		<b>□ 446TREP</b> ■ 445TREP Tasto intercambiabile illuminabile con simbolo RESISTENZA ELETTRICA - 1 modulo <i>Interchangeable rocker with lightable ELECTRICAL RESISTANCE symbol - 1 module</i>		2,52	14	14
		<b>□ 446TNDP</b> ■ 445TNDP Tasto intercambiabile illuminabile con simbolo/scritta DO NOT DISTURB - 1 modulo <i>Interchangeable rocker with lightable DO NOT DISTURB symbol - 1 module</i>		2,52	14	14

45

Sistema 45

## Commutatori 250V~ Rolling blind switches 250V~

Whitek	Tekla	Descrizione Description	Info	€	□	□
		<b>□ 446051</b> ■ 445051 Commutatore 1P 10AX (3 morsetti) - 3 posizioni (OFF centrale) - con interblocco: non è consentita la chiusura contemporanea dei 2 circuiti - 2 tasti - con frecce direzionali - 1 modulo <i>1P 10AX rolling blind switch (3 terminals) - 3 positions (central OFF) - with interlock: the simultaneous closure of the 2 circuits is not allowed - 2 rockers - with arrows - 1 module</i>		19,98	1	10
		<b>□ 446052</b> ■ 445052 Commutatore 2P 10AX (6 morsetti) - 3 posizioni (OFF centrale) - con interblocco: non è consentita la chiusura contemporanea dei 2 circuiti - 2 tasti - con frecce direzionali - 1 modulo <i>2P 10AX rolling blind switch (6 terminals) - 3 positions (central OFF) - with interlock: the simultaneous closure of the 2 circuits is not allowed - 2 rockers - with arrows - 1 module</i>		24,33	1	10
		<b>□ 446053</b> ■ 445053 Commutatore 1P 10A (3 morsetti) a pulsante - 3 posizioni (OFF centrale) - con interblocco: non è consentita la chiusura contemporanea dei 2 circuiti - 2 tasti - con frecce direzionali - 1 modulo <i>1P 10A rolling blind push-button (3 terminals) - 3 positions (central OFF) - with interlock: the simultaneous closure of the 2 circuits is not allowed - 2 rockers - with arrows - 1 module</i>		20,81	1	10
		<b>□ 446054</b> ■ 445054 Commutatore 2P 10A (6 morsetti) a pulsante - 3 posizioni (OFF centrale) - con interblocco: non è consentita la chiusura contemporanea dei 2 circuiti - 2 tasti - con frecce direzionali - 1 modulo <i>2P 10A rolling blind push-button (6 terminals) - 3 positions (central OFF) - with interlock: the simultaneous closure of the 2 circuits is not allowed - 2 rockers - with arrows - 1 module</i>		21,37	1	10
		<b>□ 446051BS</b> ■ 445051BS Commutatore a bascula 1P 10AX 3 posizioni (OFF centrale) con frecce direzionali - 1 modulo <i>1P 10AX rolling blind switch 3 positions (central OFF) with arrows - 1 module</i>		18,09	1	10
		<b>□ 446053BS</b> ■ 445053BS Commutatore pulsante a bascula 1P 10A 3 posizioni con frecce direzionali - 1 modulo <i>1P 10A rolling blind push-button 3 positions (central OFF) with arrows - 1 module</i>		17,85	1	10
		<b>■ 445051LV</b> Commutatore a levetta 1P 10AX (3 morsetti) - 3 posizioni (OFF centrale) - con interblocco - con frecce direzionali - 1 modulo <i>1P 10AX toggle rolling blind (3 terminals) - 3 positions (central OFF) - with interlock - with arrows - 1 module</i>		29,38	1	1
		<b>■ 445053LV</b> Commutatore pulsante senza freccia a levetta 1P 10A (3 morsetti) - 3 posizioni (OFF centrale) - con interblocco - 1 modulo <i>1P 10A toggle push button rolling blind (3 terminals) - 3 positions (central OFF) without arrow - with interlock - 1 module</i>		29,64	1	1

Nota: 44...052 e 44...54 utilizzabili per inversione di marcia, es. motori abbaini. Comandi non illuminabili.  
 Note: 44...52 and 440054 usable for reversing, e.g. dormer motors. Not lightable controls.

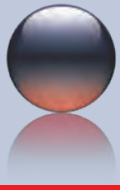

### Applicazioni con 44..016S Applications with 44..016S

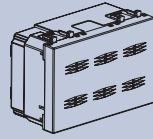

446016S  
445016S

Dispositivo Multi Touch "a sfioramento"  
Multi touch control device

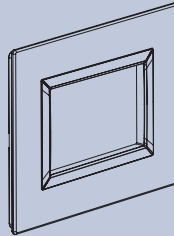

44PV3...  
Placca "Vera 44" per scatola rettangolare  
"Vera 44" front plate for rectangular box

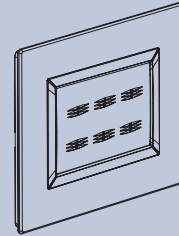

44..016S + 44PV3...

### Personalizzazione comando 44..016S Customization touch control device 44..016S

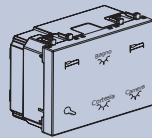

446016S  
445016S

Dispositivo Multi Touch "a sfioramento" personalizzato  
Customized multi touch control device

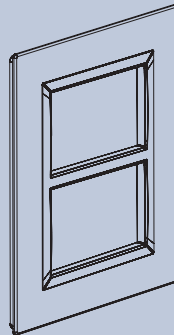

44PV33...  
Placca "Vera 44" per scatola BL02P  
"Vera 44" front plate for BL02P box

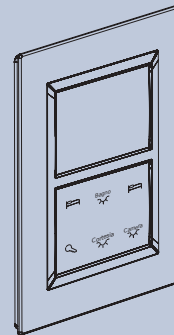

44..016S + 44PV33...

Per verificarne la fattibilità e i costi contattare la rete commerciale Ave Please check costs and feasibility with Ave export sales department.

### Applicazioni con 442TC05 Applications with 442TC05

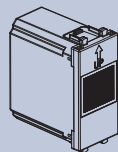

442TC05  
Pulsante "a scomparsa"  
Touch push-button "hidden installation"

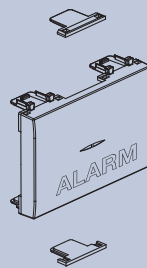

441013A/3  
445013A/3  
449013A/3  
Tappo copriforo attrezzabile  
Equippable blank insert

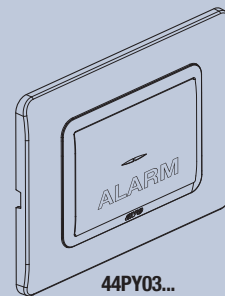

44PY03...  
Placche 3 moduli S44  
S44 3 modules front plates

### Esempi di personalizzazione Customization examples



Per la disponibilità contattare la rete commerciale  
For availability please contact sales dept.













Disponibilità fino ad esaurimento scorte  
Available until stock out

# Prodotto per scatola rettangolare inglese  
Product for British standard rectangular box

△ Prodotto per Export  
For Export only



Comandi 230V~ "a sfioramento"  
"Touch" controls 230V~

Whitek	Tekla	Descrizione Description	Info	€	<input type="checkbox"/>	<input type="checkbox"/>
 446001S	 445001S	<p><input type="checkbox"/> 446001S    <input checked="" type="checkbox"/> 445001S</p> <p>Interruttore elettronico con uscita a relè 1P NA 6A 230V~ - comando mediante sfioro superficie frontale o da più punti con normali pulsanti NA - funzionamento bistabile - led di individuazione al buio a basso consumo - memorizzazione dello stato del relè d'uscita in caso di interruzione di rete - alimentazione 230V~ - 1 modulo <i>Electronic touch switch - relay output 1P NO 6A 230V~ - controlled by touching the frontal area or from multiple points with NO push buttons - bistable operating mode - low consumption led for identification in the dark - output relay status memorization in case of black out - 230V~ power supply - 1 module</i></p>		76,21	1	10
 446005S	 445005S	<p><input type="checkbox"/> 446005S    <input checked="" type="checkbox"/> 445005S</p> <p>Pulsante elettronico per comando remoto con sensore a sfioramento - comando mediante sfioro superficie frontale - funzionamento monostabile - led di individuazione al buio a basso consumo - alimentazione 230V~ - da abbinare a interruttore elettronico 441001S, dimmer a sfioramento 441048SU o commutatore a sfioramento 441051S - 1 modulo <i>Electronic push button for remote control with touch sensor - controlled by touching the frontal area - monostable operating mode - low consumption led for identification in the dark - 230V~ power supply - to be combined with electronic switch 441001S, with touch dimmer 441048SU or touch rolling blind switch 441051S - 1 module</i></p>		70,19	1	10
 446016S	 445016S	<p><input type="checkbox"/> 446016S    <input checked="" type="checkbox"/> 445016S</p> <p>Comando elettronico multi-touch con 6 uscite a relè monostabili con contatto in chiusura 1P NA 2A 230V~ libero da potenziale - comando mediante sfioro superficie frontale o da più punti con normali pulsanti NA - funzionamento uscite: monostabili, bistabili o temporizzate, tapparelle (con interblocco funzionale) - n° 6 led frontali (di cui solo massimo 6 contemporaneamente accesi) di individuazione al buio a basso consumo - memorizzazione dello stato dei relè d'uscita in caso di interruzione di rete - alimentazione 100÷240V~ 50-60 Hz - 3 moduli <i>Electronic multi-touch control - 6 monostable output-relay 1P NO 2A 230V~ Dry contact - controlled by touching the frontal area or from multiple points with NO push-buttons - operating mode: monostable, bistable or timed, curtains (with interlock) - n. 6 led consumption front leds for identification in the darkness (max 6 leds active at the same time) - status memory in case of blackout - powered 100÷240 V ~ 50-60 HZ - 3 modules.</i></p>		245,52	1	1
 446051S	 445051S	<p><input type="checkbox"/> 446051S    <input checked="" type="checkbox"/> 445051S</p> <p>Commutatore elettronico con uscita a 2 relè monostabili con contatto in chiusura NA 2A 230V~ - comando mediante sfioro superficie frontale o da più punti con normali pulsanti NA - funzionamento monostabile o temporizzato - led di individuazione al buio a basso consumo - alimentazione 230V~ - 1 modulo <i>Electronic touch rolling blind switch with 2 monostable relay output, NO contact 2A 230V~ - controlled by touching the frontal area or from multiple points with NO push buttons - monostable or timed operating mode - low consumption LED for identification in the dark - 230V~ power supply - 1 module</i></p>		84,27	1	10
 446051S	 445048SU	<p><input checked="" type="checkbox"/> 445048SU</p> <p>Regolatore di luminosità 230V~ per carichi resistivi e induttivi (lampade ad incandescenza e alogene 40-400W, trasformatori ferromagnetici per lampade alogene in bassissima tensione 40-400VA, trasformatori elettronici con comportamento induttivo  40-300VA tipo OSRAM HALOTRONIC HTM 70/230-240, HTM 105/230-240, HTM 150/230-240) - comando e regolazione mediante sfioro superficie frontale o da più punti con normali pulsanti NA - led di individuazione al buio a basso consumo - memorizzazione dello stato e del livello dell'uscita in caso d'interruzione di rete - 1 modulo 230V~ dimmer for resistive and inductive loads (incandescent and halogen lamps 40-400W, ferromagnetic transformers for low voltage 40-400 VA halogen lamps, electronic inductive transformer type  40-300VA OSRAM HALOTRONIC HTM 70/230-240, HTM 105/230-240, HTM 150/230-240) - controlled by touching the frontal area or from multiple points with NO buttons - low consumption led for identification in the darkness - status and level memory in case of black out - 1 module</p>		87,61	1	10



Sistema 45



# Serie WHITEK - TEKLA

WHITEK - TEKLA series

Dimmer per regolazione luci  
Dimmer for lighting controls



48

Whitek

Tekla

Descrizione Description

Info

€



446018



445018

446018     445018

Regolatore di luminosità 230V~ (127 V~) 50-60Hz per carichi resistivi (lampade ad incandescenza e alogene) 60÷800W (30÷500W) e induttivi (trasformatori ferromagnetici ed elettronici) 40÷300VA - regolazione con potenziometro rotativo - led di individuazione al buio - non dotato di filtro EMC - 1 modulo  
*Dimmer 230V~ (127 V~) 50-60Hz for resistive loads (incandescent and halogen lamps) 60÷800W (30÷500W) and inductive (ferromagnetic and electronic transformers) 40÷300VA - regulation with rotary potentiometer - led for identification in the dark - EMC filter not included - 1 module*

41,95 1 6



445048

445048

Regolatore di luminosità 230V~ (127 V~) 50-60Hz - TRIAC - taglio di fase per lampade ad incandescenza e alogene 100÷500W - regolazione con potenziometro rotativo - led di individuazione al buio - 1 modulo  
*Dimmer 230V~ (127 V~) 50-60Hz for resistive loads (incandescent and halogen lamps) 100÷500W (60÷300W) - regulation with rotary potentiometer - led for identification in the dark - 1 module*

43,02 1 6



446048D



445048D

446048D     445048D

Regolatore di luminosità 230V~ 50-60Hz - TRIAC - taglio di fase per lampade ad incandescenza e alogene 40÷300W - comando con deviatore incorporato e regolazione con potenziometro rotativo - led di individuazione al buio - profondità ridotta - viti dei morsetti laterali - 1 modulo  
*Dimmer 230V~ 50-60Hz for resistive loads (incandescent and halogen lamps) 40÷300W - control with built-in two-way switch and regulation with rotary potentiometer - led for identification in the dark - reduced depth - side terminal screws - 1 module*

52,07 1 6



446048UL



445048UL  
445048U

446048UL     445048UL

Regolatore di luminosità 230V~ 50-60 Hz per carichi resistivi e induttivi (lampade ad incandescenza e alogene 3-220W, trasformatori elettronici 20-220W, lampade LED 3-120W, lampade CFL 3-220W - alimentatori elettronici LED a taglio di fase) - comando e regolazione con pulsante incorporato o da più punti con normali pulsanti NA - led di individuazione al buio a basso consumo - memorizzazione dello stato e del livello dell'uscita in caso d'interruzione di rete - 1 modulo  
*230V~ 50-60 Hz dimmer for resistive and inductive loads (3-220W incandescent and halogen lamps, ferromagnetic transformers 20-220W, LED lamps 3-120W, CFL lamps 3-220W - electronic ballasts for LED with line interruption) - control and regulation by built-in push-button or by normal NO push-button from more points - low consumption led for identification in the dark - status and level memory in case of blackout - 1 module*

92,30 1 6



446048UR



445048UR

446048UR     445048UR

Regolatore di luminosità 230V~ 50Hz per lampade ad incandescenza, alogene e LED 3-120W - regolazione con potenziometro rotativo - non dotato di filtro EMC - 1 modulo  
*Dimmer 230V~ 50Hz for incandescent, halogen and LED lamps 3-120W - adjustment with rotary potentiometer - not equipped with EMC filter - 1 module*



47,85 1 1

445048AE

Regolatore per alimentatori elettronici ingresso 1÷10V - contatto 4A/250V~ - 1 modulo  
*Dimmer for electronic power units input 1÷10V - contact 4A/250V~ - 1 module*

87,56 1 6



445048AE

**Nota:** 441018 utilizzabile solo in paesi non membri dell'Unione Europea

**Note:** 441018 must be used only in non-EU Countries



Per la disponibilità contattare la rete commerciale  
For availability please contact sales dept.



Disponibilità fino ad esaurimento scorte  
Available until stock out



Prodotto per scatola rettangolare inglese  
Product for British standard rectangular box



Prodotto per Export  
For Export only

## Comandi a chiave key commands

Whitek		Tekla	Descrizione Description	Info	€	<input type="checkbox"/>	<input type="checkbox"/>	49
				<p><input type="checkbox"/> 446071    <input checked="" type="checkbox"/> 445071</p> <p>Interruttore 2P 10AX con chiave - codifica chiave casuale - fornito con 2 chiavi - la chiave esce in entrambe le posizioni - 1 modulo <i>2P 10AX one way switch with key - random key coding - supplied with 2 keys - the key exits in both positions - 1 module</i></p>	53,97	1	10	
446071 446071EA 446071MCEA	445071 445071EA 445071MCEA		<p><input type="checkbox"/> 446071EA    <input checked="" type="checkbox"/> 445071EA</p> <p>Interruttore 2P 10AX con chiave estraibile solo in posizione di aperto- codifica chiave casuale - fornito con 2 chiavi - 1 modulo <i>2P 10AX one way switch with key - random key coding - supplied with 2 keys - the key exits in 0 position - 1 module</i></p>	53,97	1	10		
			<p><input type="checkbox"/> 446071MCEA    <input checked="" type="checkbox"/> 445071MCEA</p> <p>Interruttore 2P 10AX con chiave estraibile solo in posizione di aperto - codifica chiave "511" - fornito con 2 chiavi - 1 modulo <i>2P 10AX one way switch with key - key code "511" - supplied with 2 keys - the key exits in 0 position - 1 module</i></p>	53,97	1	10		
				<p><input type="checkbox"/> 446072    <input checked="" type="checkbox"/> 445072</p> <p>Deviatore 1P 10AX con chiave - codifica chiave casuale - fornito con 2 chiavi - la chiave esce in entrambe le posizioni - 1 modulo <i>1P 10AX two way switch with key - random key encoding - supplied with 2 keys - the key exits in both positions - 1 module</i></p>	55,09	1	10	
446072	446072EA	445072	445072EA	<p><input type="checkbox"/> 446075    <input checked="" type="checkbox"/> 445075</p> <p>Pulsante 2P NA 10A con chiave - codifica chiave casuale - fornito con 2 chiavi - la chiave esce solo in posizione di aperto - 1 modulo <i>2P NO 10A push-button with key - random key coding - supplied with 2 keys - the key exits only in the open position - 1 module</i></p>	54,64	1	10	
			<p><b>Note:</b> ✓ a richiesta i deviatori a chiave 44..072 potranno essere forniti con chiave estraibile solo in posizione "0"</p> <p><b>Note:</b> ✓ 44..072 two way switches with key can be supplied with key removable only in the "0" position upon request</p>					
446075	446075EA	445075	445075EA					

Sistema 45

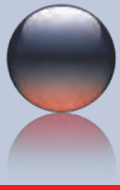

# Serie WHITEK - TEKLA

WHITEK - TEKLA series

Rilevatori di presenza  
Detectors



### Diagramma di copertura *Covering Diagram*

Vista in pianta *Plan view*

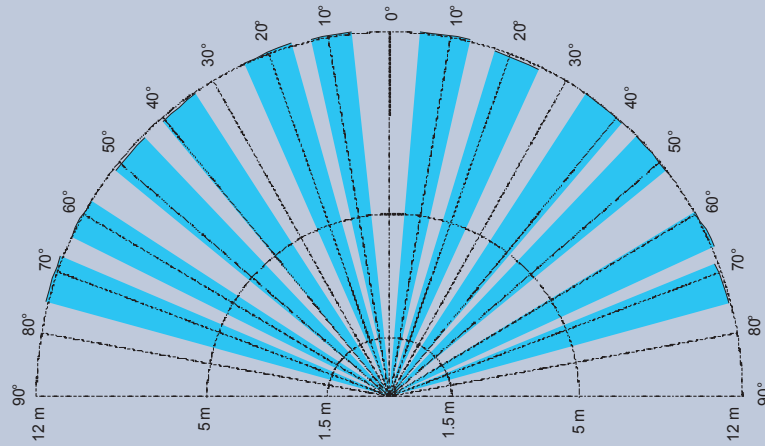

Vista laterale *Side view*

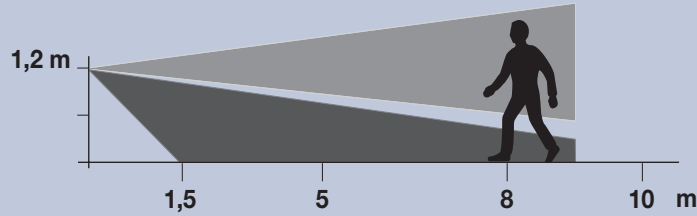

### Schemi applicativi *Application Diagrams*

Installazione per comando carico da due o più punti di rivelazione  
*Installation to control the load from two or more detecting spots*

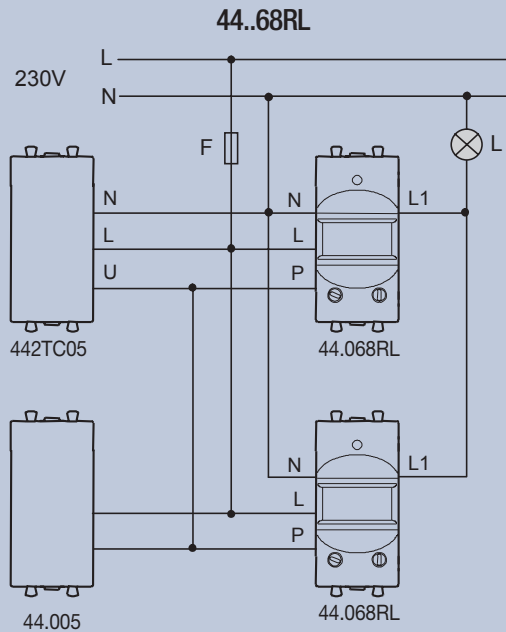

L: carico NA 10A 230V    L: load NA 10A 230V    F: fusibile tipo T 10 H 250 V    F: fuse type T 10 H 250 V



Per la disponibilità contattare la rete commerciale  
For availability please contact sales dept.



Disponibilità fino ad esaurimento scorte  
Available until stock out



Prodotto per scatola rettangolare inglese  
Product for British standard rectangular box



Prodotto per Export  
For Export only











## Rilevatori di presenza Detectors

Whitek	Tekla	Descrizione Description	Info	€	□	□
		<p>□ 446068RL    ■ 445068RL</p> <p>LUCE AMICA Rivelatore di movimento a raggi infrarossi per accensione luci - uscita a relè NA 10(4)A 230V~ - alimentazione 110÷230V~ - regolazione frontale del ciclo di temporizzazione da 10 s a 7 min - regolazione frontale della soglia della luminosità ambiente - lente fissa con portata regolabile da 2 m a 12 m e apertura 150° - ingresso per pulsanti di comando remoti - possibilità di impostazione funzionamento: Automatico/Crepuscolare/Forzatura ON/Semiautomatico - 1 modulo</p> <p>LUCE AMICA Infrared motion detector for lighting control - NO 10(4)A 230V~ output relay - 110÷230V~ power supply - Frontal duty cycle time regulation from 10 s to 7 min - Frontal regulation of light sensitivity threshold - fixed lens range from 2 m to 12 m and 150° opening - input for remote controls push buttons - possibility to set operating mode: Automatic/Night/Forced ON/Semi-Automatic - 1 module</p>	135,74	1	6	

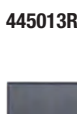

Sistema 45

## Copriforo e uscita Blank insert and cable outlet

Whitek	Tekla	Descrizione Description	Info	€	□	□
		<p>□ 446008    ■ 445008</p> <p>Uscita Ø 9 mm con serracavo antitrazione - consente il passaggio di cavi da Ø 4 mm a Ø 8 mm - 1 modulo</p> <p>Cable outlet Ø 9 mm with cable grip - it allows the passage of cables from Ø 4 mm to Ø 8 mm - 1 module</p>	3,37	10	100	
		<p>□ 446013    ■ 445013</p> <p>Tappo copriforo - pretranciatura posteriore centrale per agevolare eventuali fori - 1 modulo</p> <p>Blank insert - central pre-cut in rear side to facilitate any holes - 1 module</p>	1,31	10	300	
		<p>□ 446013R    ■ 445013R</p> <p>Tappo copriforo attrezzabile - pretranciatura posteriore centrale per agevolare eventuali fori - 1/2 modulo</p> <p>Equippable blank insert - central pre-cut in rear side to facilitate any holes - 1/2 module</p>	2,89	12	72	
		<p>□ 446013A/2    ■ 445013A/2</p> <p>Tappo copriforo attrezzabile - predisposizione per aggancio a involucro vuoto - 2 moduli</p> <p>Equippable blank insert - preset for clipping it to empty base - 2 modules</p>	2,76	4	24	
		<p>■ 445013A/3</p> <p>Tappo copriforo attrezzabile - predisposizione per aggancio a involucro vuoto - 3 moduli</p> <p>Equippable blank insert - preset for clipping it to empty base - 3 modules</p>	4,33	2	14	
						
						

**Nota:** a richiesta potrà essere fornito l'involucro per l'aggancio al tappo copriforo 446013A/2 e 445013A/3  
**Note:** the base for the 446013A/2 and 445013A/3 blank insert clipping can be supplied upon request



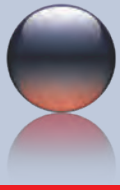

## Serie WHITEK - TEKLA

WHITEK - TEKLA series

Prese di corrente e speciali  
Standard and special socket outlets

NEW WIRING ACCESSORIES

BREVETTO AVE N° 254 MODELLO COMUNITARIO  
AVE PATENT N° 254 EU MODEL

52

AVE presenta un innovativo monoblocco multiprese con brevetto Ave. Una novità assoluta sul mercato che permette di integrare, anche nella tradizionale scatola da incasso a tre moduli, fino a 4 combinazioni: una presa bipasso, una presa schuko, una presa USB tipo A e una presa USB tipo C (uscita 3A).

La velocità di installazione è un altro grande vantaggio di questo prodotto.

È sufficiente un singolo cablaggio per collegare il dispositivo e dotare un punto-prese fino a 4 combinazioni.

AVE presents an innovative multi-socket monobloc with AVE patent. An absolute novelty on the market which allows to integrate up to 4 combinations also in the traditional three-module flush-mounted box: a combined Italian standard socket, a schuko socket, a USB type A socket and a USB type C socket (output 3A).

Speed of installation is another great advantage of this product.

A single cable is enough to connect the device and equip a socket-point with combinations up to 4 sockets.

Caratteristiche Tecniche Technical Features

# -50%

tempo di LAVORO

working time



# x2

produttività  
productivity

Il tutto in un'unica combinazione, installabili in scatole standard a 3 moduli uscita - USB 3A con utilizzo della singola presa  
All in a single combination, which can be installed in standard 3-module boxes - USB 3A output using the single socket



Per la disponibilità contattare la rete commerciale  
For availability please contact sales dept.



Disponibilità fino ad esaurimento scorte  
Available until stock out



















Prodotto per scatola rettangolare inglese  
Product for British standard rectangular box



Prodotto per Export  
For Export only





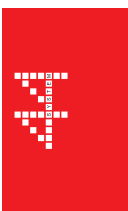



## Prese di corrente e speciali Standard and special socket outlets

Whitek	Tekla	Descrizione Description	Info	€	□	□
 44609015USB	 44509015USB	<p>□ <b>44609015USB</b>            Presa bipasso P17/11 2P+T 10/16A - Presa schuko bipasso P40 (UNIVERSALE) 2P+T 10/16A - alveoli schermati - USB 5V 1 uscita di tipo C - 1 uscita di tipo A - carico max in uscita 3A - 3 moduli</p> <p><i>P17/11 2P+E 10/16A Combined Italian standard socket - P40 (UNIVERSAL) 2P+E 10/16A Schuko + Italian standard socket - shuttered - USB 5V - 1 type C outlet - 1 type A outlet - max output load 3A - 3 modules</i></p>	 	57,38	2	2
 44609015MB	 44509015MB	<p>■ <b>44509015USB</b>            Presa bipasso P17/11 2P+T 10/16A - Presa schuko bipasso P40 (UNIVERSALE) 2P+T 10/16A - alveoli schermati - USB 5V 1 uscita di tipo C - 1 uscita di tipo A - carico max in uscita 3A - 3 moduli</p> <p><i>P17/11 2P+E 10/16A Combined Italian standard socket - P40 (UNIVERSAL) 2P+E 10/16A Schuko + Italian standard socket - shuttered - USB 5V - 1 type C outlet - 1 type A outlet - max output load 3A - 3 modules</i></p>	 	57,38	2	2
 44609015MB	 44509015MB	<p>□ <b>44609015MB</b>            Presa bipasso P17/11 2P+T 10/16A - Presa schuko bipasso P40 (UNIVERSALE) 2P+T 10/16A - alveoli schermati - 3 moduli</p> <p><i>P17/11 2P+E 10/16A Combined Italian standard socket - P40 (UNIVERSAL) 2P+E 10/16A Schuko + Italian standard socket - shuttered - 3 modules</i></p>	 	25,49	3	30
 44609015MB	 44509015MB	<p>■ <b>44509015MB</b>            Presa bipasso P17/11 2P+T 10/16A - Presa schuko bipasso P40 (UNIVERSALE) 2P+T 10/16A - alveoli schermati - 3 moduli</p> <p><i>P17/11 2P+E 10/16A Combined Italian standard socket - P40 (UNIVERSAL) 2P+E 10/16A Schuko + Italian standard socket - shuttered - 3 modules</i></p>	 	25,49	3	30



Sistema 45

## Prese di corrente standard esteri Various standards socket outlets

Whitek	Tekla	Descrizione Description	Info	€	□	□
 44603392MB	 44503392MB	<p>□ <b>44603392MB</b> ■ <b>44503392MB</b>            Presa polarizzata euroamericana 2P 16A 250V~ più presa standard francese 2P+T 16A 250V~, alveoli schermati - 3 moduli</p> <p><i>2P 16A 250V~ Euro-American polarized socket + 2P+E 16A 250V~ French standard socket, shielded sockets - 3 modules</i></p>	 	19,90	3	30
 44603392USB	 44503392USB	<p>□ <b>44603392USB</b> ■ <b>44503392USB</b>            Presa polarizzata euroamericana 2P 16A 250V~ più presa standard francese 2P+T 16A 250V~, alveoli schermati - USB 5V 1 uscita tipo C - 1 uscita di tipo A - carico max in uscita 3A - 3 moduli</p> <p><i>2P 16A 250V~ Euro-American polarized socket + 2P+E 16A 250V~ French standard socket, shielded sockets - USB 5V 1 type C output - 1 type A output - max output load 3A - 3 modules</i></p>	 	58,71	2	2

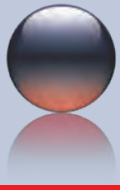

## Serie WHITEK - TEKLA

WHITEK - TEKLA series



Prese di corrente standard italiano 250V~  
250V~ Italian standard socket outlets

54

### Prese Standard Italiano Italian Standard Socket Outlets



Morsetto di terra evidenziato per un'immediata  
identificazione  
Earth terminal highlighted for immediate identification

### Prese Schuko Schuko Socket Outlets

Presca con sportello Socket with lid



Presca illuminata Illuminated socket outlet

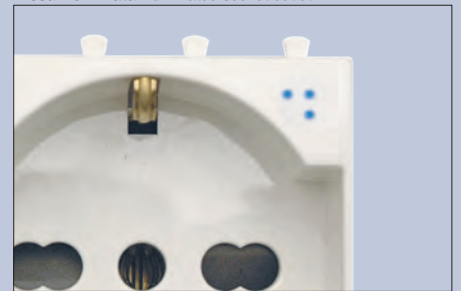

Consigliato l'utilizzo di Lampada a led  
colore blu (cod. 0230LDB)  
It is recommended the  
use of blue colour led lamp (code 0230LDB)

### Prese Schuko bipasso Combined Schuko + Italian standard socket

Prese Schuko  
Schuko Sockets

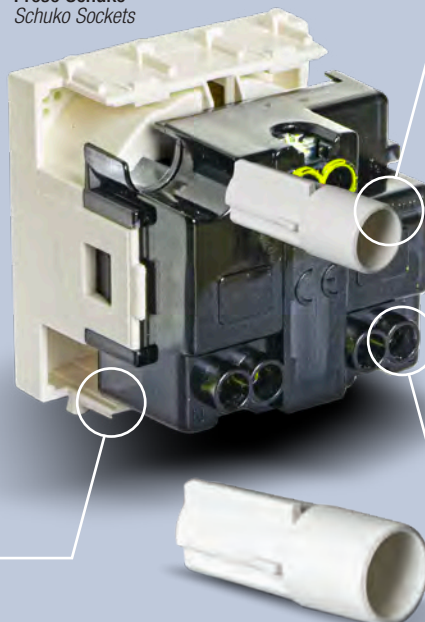

Adattatore per lampada  
di segnalazione  
Adaptor for led lamp



Collare consente l'ingresso  
del doppio puntale  
per il filo da 2,5 mm  
This terminal allows an easy  
entry of the double tip for  
2.5mm wire

Ingombro ridotto  
Reduced footprint

Caratteristiche Tecniche Technical Features



Per la disponibilità contattare  
la rete commerciale  
For availability please contact  
sales dept.



Disponibilità fino ad  
esaurimento scorte  
Available until stock out



Prodotto per scatola  
rettangolare inglese  
Product for British standard  
rectangular box



Prodotto  
per Export  
For Export  
only

Prese di corrente standard italiano 250V~  
250V~ Italian standard socket outlets

Whitek	Tekla	Descrizione Description	Info	€	□	□
		<input type="checkbox"/> 446006/15TS <input checked="" type="checkbox"/> 445006/15TS Presa bipasso P17/11 2P+T 10/16A - alveoli schermati - possibilità di utilizzo del ponticello isolato cod. 442PONTE per il cablaggio rapido di più prese affiancate - 1 modulo <i>Combined P17/11 Italian standard socket 2P+E 10/16A - shuttered - possibility of using insulated jumper code 442PONTE for rapid wiring of more sockets side by side 1 module</i>		7,14	10	100
446006/15TS	445006/15TS	<input type="checkbox"/> 446006TS <input checked="" type="checkbox"/> 445006TS Presa P11 2P+T 10A - alveoli schermati - possibilità di utilizzo del ponticello isolato cod. 442PONTE per il cablaggio rapido di più prese affiancate - 1 modulo <i>P11 2P+E 10A socket - shuttered - possibility of using insulated jumper code 442PONTE for rapid wiring of more sockets side by side - 1 module</i>		6,65	10	100
		<input type="checkbox"/> 446090TS <input checked="" type="checkbox"/> 445090TS Presa schuko P30 2P+T 16A - alveoli schermati - illuminabile (segnalazione presenza rete) - contatti di terra laterale e centrale - 2 moduli <i>P30 2P+E 16A Schuko socket - shuttered - lighttable (indicating the presence of the line) - lateral and central earth contacts - 2 modules</i>		12,47	5	50
446006TS	445006TS	<input type="checkbox"/> 446090TSS <input checked="" type="checkbox"/> 445090TSS Presa schuko P30 2P+T 16A con sportello - alveoli schermati - contatti di terra laterale e centrale - 2 moduli <i>P30 2P+E 16A Schuko socket with lid - shuttered - lateral and central earth contacts - 2 modules</i>		13,65	5	50
		<input type="checkbox"/> 446090/15TS <input checked="" type="checkbox"/> 445090/15TS Presa schuko bipasso P40 (UNIVERSALE) 2P+T 10/16A - alveoli schermati - illuminabile (segnalazione presenza rete) - 2 moduli <i>2P+E 10/16A (UNIVERSAL) combined Schuko + Italian standard socket - shuttered - lighttable (indicating the presence of the line) - 2 modules</i>		13,31	5	50
446090TS	445090TS	<input type="checkbox"/> 442PONTE Ponticello isolato per cablaggio rapido di 2 prese affiancate standard italiano 1 modulo - unico blocco fase/terra/neutro - consigliato l'utilizzo con cavi di sezione 2,5 mm <sup>2</sup> o 4 mm <sup>2</sup> <i>Insulated jumper for rapid wiring of 2 Italian standard 1 module sockets side by side - single block phase/earth/neutral - it is recommended the use of 2,5 mm<sup>2</sup> or 4 mm<sup>2</sup> cables</i>		0,99	50	50
446090TSS	445090TSS					
446090/15TS	445090/15TS					
442PONTE						

Nota: gli articoli illuminabili sono forniti senza lampada di segnalazione  
 Note: lighttable articles are supplied without lamp

Presse per rasoi 240V~ 240V~ shaver socket

Whitek	Tekla	Descrizione Description	Info	€	□	□
		<input type="checkbox"/> 446033RS <input checked="" type="checkbox"/> 445033RS Presa per rasoi con trasformatore di isolamento 20VA - standard euroamericano - alimentazione 240V~ - tensione prelevabile in uscita selezionabile tramite commutatore 240V~ o 120V~ - alveoli schermati - 3 moduli <i>Shaver socket with 20VA insulating transformer - Euro-American standard - 240V~ input - selectable output voltage 240V~ or 120V~ - shuttered - 3 modules</i>		107,38	1	1
446033RS	445033RS					

Nota: la presa è munita di dispositivo di autoprotezione contro il sovraccarico  
 Note: the socket is supplied with a built-in surge protection device

Sistema 45



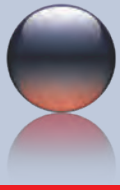

# Serie WHITEK - TEKLA

WHITEK - TEKLA series



Prese di corrente per linee dedicate 250V~  
Socket outlets for dedicated circuits 250V~

Caratteristiche Tecniche Technical Features

## Campo di applicazione prevalente *Predominant field of application*

**Rosso:**  
Linee alimentate da sistema statico di continuità UPS  
*Red:*  
Line powered by a UPS



**Verde:**  
Linee alimentate da rete/gruppo elettrogeno  
*Green:*  
Line powered by a network/power unit



**Arancione:**  
Linee alimentate da rete/gruppo elettrogeno e trasformatore di isolamento  
*Orange:*  
Line powered by a network/power unit and insulation transformer

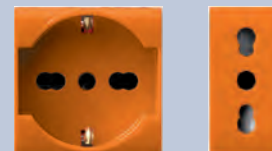

**Nota: esempi di impiego puramente indicativi non esistendo prescrizioni normative specifiche**  
*Nota: the above examples are purely indicative as no specific standard regulations are available*



Per la disponibilità contattare la rete commerciale  
For availability please contact sales dept.



Disponibilità fino ad esaurimento scorte  
Available until stock out



Prodotto per scatola rettangolare inglese  
Product for British standard rectangular box



Prodotto per Export  
For Export only



Prese di corrente per linee dedicate 250V~  
Socket outlets for dedicated circuits 250V~

		Descrizione Description	Info	€	<input type="checkbox"/>	<input type="checkbox"/>
		<p>■ <b>442006/15TSR</b>            Presa bipasso P17/11 2P+T 10/16A - alveoli schermati - rossa - possibilità di utilizzo del ponticello isolato cod. 442PONTE per il cablaggio rapido di più prese affiancate - 1 modulo  <i>Combined P17/11 Italian standard socket 2P+E 10/16A - shuttered - red - possibility of using insulated jumper code 442PONTE for rapid wiring of more sockets side by side - 1 module</i></p>		9,39	10	100
442006/15TSR	442090/15TSR					
		<p>■ <b>442006/15TSV</b>            Presa bipasso P17/11 2P+T 10/16A - alveoli schermati - verde - possibilità di utilizzo del ponticello isolato cod. 442PONTE per il cablaggio rapido di più prese affiancate - 1 modulo  <i>Combined P17/11 Italian standard socket 2P+E 10/16A - shuttered - green - possibility of using insulated jumper code 442PONTE for rapid wiring of more sockets side by side - 1 module</i></p>		9,39	10	100
442006/15TSV	442090/15TSV					
		<p>■ <b>442006/15TSA</b>            Presa bipasso P17/11 2P+T 10/16A - alveoli schermati - arancione - possibilità di utilizzo del ponticello isolato cod. 442PONTE per il cablaggio rapido di più prese affiancate - 1 modulo  <i>Combined P17/11 Italian standard socket 2P+E 10/16A - shuttered - orange - possibility of using insulated jumper code 442PONTE for rapid wiring of more sockets side by side - 1 module.</i></p>		9,39	10	100
442006/15TSA	442090/15TSA					
		<p>■ <b>442090TSR</b>            Presa schuko P30 2P+T 16A - alveoli schermati - rossa - illuminabile (segnalazione presenza rete) - contatti di terra laterale e centrale - 2 moduli  <i>P30 2P+E 16A Schuko socket - shuttered - red - lighttable (indicating the line presence) - lateral and central earth contacts - 2 modules</i></p>		13,85	5	50
442090TSR						
		<p>■ <b>442090/15TSR</b>            Presa schuko bipasso P40 (UNIVERSALE) 2P+T 10/16A - alveoli schermati - rossa illuminabile (segnalazione presenza rete) - 2 moduli  <i>2P+E 10/16A (UNIVERSAL) Schuko + Italian standard socket - shuttered - red lighttable (indicating the line presence) - 2 modules</i></p>		16,98	5	50
		<p>■ <b>442090/15TSV</b>            Presa schuko bipasso P40 (UNIVERSALE) 2P+T 10/16A - alveoli schermati - verde - illuminabile (segnalazione presenza rete) - 2 moduli  <i>2P+E 10/16A (UNIVERSAL) Schuko + Italian standard socket - shuttered - green - lighttable (indicating the line presence) - 2 modules</i></p>		16,98	5	50
		<p>■ <b>442090/15TSA</b>            Presa schuko bipasso P40 (UNIVERSALE) 2P+T 10/16A - alveoli schermati - arancione - illuminabile (segnalazione presenza rete) - 2 moduli  <i>2P+E 10/16A (UNIVERSAL) Schuko + Italian standard socket - shuttered - orange - lighttable (indicating the line presence) - 2 modules</i></p>		16,98	5	50
		<p>■ <b>442092TSR</b>            Presa standard francese 2P+T 16A - alveoli schermati - rossa - con terra - illuminabile (segnalazione presenza rete) - 2 moduli  <i>2P+E 16A French standard socket - shuttered - red - with earth - lighttable (indicating the line presence) - 2 modules</i></p>		14,13	5	50
442092TSR		<p><b>Nota:</b> gli articoli illuminabili sono forniti senza lampada di segnalazione  <b>Nota:</b> lighttable articles are supplied without lamp</p>				

Sistema 45



# Serie WHITEK - TEKLA

## WHITEK - TEKLA series



### Prese di corrente standard esteri Various standards socket outlets

58

Whitek



Tekla

Descrizione Description

Info

€

□ □



446033  
446033S



445033  
445033S

□ 446033 ■ 445033  
Presse polarizzata euroamericana 2P 16A 250V~ - alveoli non schermati - 1 modulo  
*2P 16A 250V~ Euro-American polarized socket - not shuttered - 1 module*

△ 7,43 10 100



446033TD



445033TD

□ 446033S ■ 445033S  
Presse polarizzata euroamericana 2P 16A 250V~ - alveoli schermati - 1 modulo  
*2P 16A 250V~ Euro-American polarized socket - shuttered - 1 module*

△ 8,01 10 100

□ 446033TD ■ 445033TD  
Presse polarizzata euroamericana 2P+T 16A 127~/250V~ - con terra laterale - alveoli non schermati - 1 modulo  
*2P+E 16A 127~/250V~ Euro-American polarized socket -with lateral earth - not shuttered - 1 module*

△ 9,86 10 100



44603392MB

□ 44603392MB ■ 44503392MB  
Presse polarizzata euroamericana 2P 16A 250V~ più prese standard francese 2P+T 16A 250V~, alveoli schermati - 3 moduli  
*2P 16A 250V~ Euro-American polarized socket + 2P+E 16A 250V~ French standard socket, shielded sockets - 3 modules*

△ 19,90 3 30



44603392USB

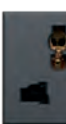

44503392USB

□ 44603392USB ■ 44503392USB  
Presse polarizzata euroamericana 2P 16A 250V~ più prese standard francese 2P+T 16A 250V~, alveoli schermati - USB 5V 1 uscita tipo C - 1 uscita di tipo A - carico max in uscita 3A - 3 moduli  
*2P 16A 250V~ Euro-American polarized socket + 2P+E 16A 250V~ French standard socket, shielded sockets - USB 5V 1 type C output - 1 type A output - max output load 3A - 3 modules*

△ 58,71 2 2



446059TS



445059TS

■ 445034S  
Presse 2P 16A 250V~ - alveoli Ø 4,8 mm - alveoli schermati - possibilità di utilizzo del ponticello isolato cod. 442PONTE per il cablaggio rapido di più prese affiancate - 1 modulo  
*2P 16A 250V~ - pins with 4,8 mm diameter - shuttered - possibility of using insulated jumper code 442PONTE for rapid wiring of more sockets side by side - 1 module*

△ 5,78 10 100



446090S



445090S

□ 446059TS ■ 445059TS  
Presse multistandard 2P+T 5/6/10/13A 250V~ - alveoli schermati - 2 moduli  
*2P+E 5/6/10/13A 250V~ multistandard socket - shuttered - 2 modules*

△ 12,55 10 10



446090SS



445090SS

□ 446090S ■ 445090S  
Presse standard tedesco 2P+T 16A 250V~ - alveoli schermati - illuminabile (segnalazione presenza rete) - 2 moduli  
*2P+E 16A 250V~ German standard socket - shuttered - lightable (indicating the presence of the line) - 2 modules*

△ 13,10 5 50



446090SS



445090SS

□ 446090SS ■ 445090SS  
Presse standard tedesco 2P+T 16A 250V~ con sportello - alveoli schermati - da utilizzare in scatole con profondità minima 45 mm - 2 moduli  
*2P+E 16A 250V~ German standard socket with lid - shuttered - to be used in boxes with min. depth 45 mm - 2 modules*

△ 16,25 5 50



446092TS

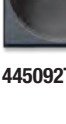

445092TS

□ 446092TS ■ 445092TS  
Presse standard francese 2P+T 16A 250V~ - alveoli schermati - con terra - illuminabile (segnalazione presenza rete) - 2 moduli  
*2P+E 16A 250V~ French standard socket - shuttered - with earth - lightable (indicating the presence of the line) - 2 modules*

△ 12,45 5 50



445092TSS

■ 445092TSS  
Presse standard francese 2P+T 16A 250V~ con sportello - alveoli schermati - con terra - da utilizzare in scatole con profondità minima 45 mm - 2 moduli  
*2P+E 16A 250V~ French standard socket with lid - shuttered - to be used in boxes with min. depth 45 mm - 2 modules*

△ 13,90 5 50



Per la disponibilità contattare la rete commerciale  
For availability please contact sales dept.



Disponibilità fino ad esaurimento scorte  
Available until stock out





Prodotto per scatola rettangolare inglese  
Product for British standard rectangular box



Prodotto per Export  
For Export only

## Prese di corrente standard esteri Various standards socket outlets





Whitek	Tekla	Descrizione Description	Info	€	□	□
		<b>446097TS</b> ■ <b>445097TS</b> Presa standard inglese BS1363 2P+T 13A 250V~ - alveoli schermati - illuminabile (segnalazione presenza rete) - 2 moduli <i>2P+E 13A 250V BS1363 British standard socket - shuttered - lighttable (indicating the presence of the line) - 2 modules</i>	△	16,41	5	50
446097TS	445097TS	<b>445023T</b> Presa standard svizzero tipo 23 con pozzetto 2P+T 16A 250V~ - alveoli non schermati 1,5 moduli <i>Swiss standard type 23 socket 2P+E 16A 250V~ - unshuttered - 1,5 modules</i>	△	9,94	7	70
		<b>Note:</b> ✓ 44..033, 44..033S, 44..033TD, 44..033TD2/3, 44..034, 44..034S, 44..059TS, 44..098T2/3 utilizzabili solo in paesi non membri dell'Unione Europea ✓ gli articoli illuminabili sono forniti senza lampada di segnalazione <b>Notes:</b> ✓ 44..033, 44..033S, 44..033TD, 44..033TD2/3, 44..034, 44..034S, 44..059TS, 44..098T2/3 must be used only in non-EU Countries ✓ the lighttable articles are supplied without lamp				

59







Sistema 45

## Prese per usi speciali e caricatori USB universali Socket outlets for special uses and Universal USB chargers

Whitek	Tekla	Descrizione Description	Info	€	□	□
		<b>446082USB3A</b> ■ <b>445082USB3A</b> Caricatore USB universale 5V 3A - n° 1 uscita USB frontale - alimentazione 110÷240V~ 50-60 Hz - assorbimento a riposo < 0,1 W - consente la ricarica di telefoni cellulari, riproduttori audio portatili, console portatili e ogni altro apparecchio elettronico che offra la possibilità di ricarica da una qualsiasi presa standard USB - 1 modulo <i>Universal USB charger 5V 3A - 1 frontal USB output - powered with 110÷240V~ 50-60 Hz - stand-by consumption &lt; 0,1 W - It allows the charging of mobile phones, mobile audio player, and all electronic devices with charging system through standard USB Inputs - 1 module</i>		28,73	1	1
446082USB3A	445082USB3A	<b>446082USBC</b> Caricatore USB tipo C - nr 1 uscita USB frontale - alimentazione 110-240V~ 50-60 Hz uscita 5V 3A - assorbimento a riposo < 0,1 W - consente la ricarica di telefoni cellulari, riproduttori audio portatili, console portatili e ogni altro apparecchio elettronico che offra la possibilità di ricarica da una qualsiasi presa standard USB tipo C - 1 modulo <i>Universal USB type C charger 5V 3A - 1 frontal USB output - powered with 110÷240V~ 50-60 Hz - stand-by consumption &lt; 0,1 W - It allows the charging of mobile phones, mobile audio player, and all electronic devices with charging system through standard USB type C Inputs - 1 module</i>		28,63	1	1
		<b>445082USBC</b> Alimentatore USB 5V con 1 uscita di tipo C, 1 uscita di tipo A - alimentazione 110÷230V~ 50-60 Hz - assorbimento a riposo < 0,1 W - carico max in uscita 3 A. 1 modulo <i>USB charger - 5V - 1 type C and 1 type A output - powered with 110÷230V~ 50-60 Hz - stand-by consumption &lt; 0,1 W - maximum output load 3A - 1 module</i>		39,62	1	1
						

## Prese telefoniche Telephone socket outlets

Whitek	Tekla	Descrizione Description	Info	€	□	□
		<b>446024</b> ■ <b>445024</b> Presa telefonica RJ11 (6 poli / 4 contatti) - morsetti a vite - 1 modulo <i>RJ11 telephone socket (6 poles / 4 contacts)- screw terminals - 1 module</i>		20,48	1	12
446024	445024	<b>446026K</b> ■ <b>445026K</b> Presa telefonica standard inglese "BT SECONDARY" (6 contatti) - morsetti a vite - 1 modulo <i>"BT SECONDARY" telephone socket (6 contacts) - screw terminals - 1 module</i>	△	13,09	2	2
						

Le dimensioni, salvo diversamente specificato, sono in mm  
Dimensions, except where otherwise specified, are in mm

 Imballo Minimo pcs  
Min. Packaging pcs

 Imballo Standard pcs  
Std. Packaging pcs

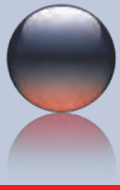

# Serie WHITEK - TEKLA

WHITEK - TEKLA series

NEW WIRING ACCESSORIES

Prese dati  
Data socket outlets

## Cablaggio universale T568A e T568B Universal wiring T568A and T568B

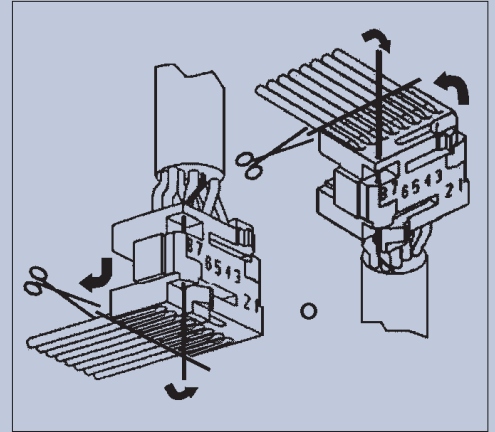
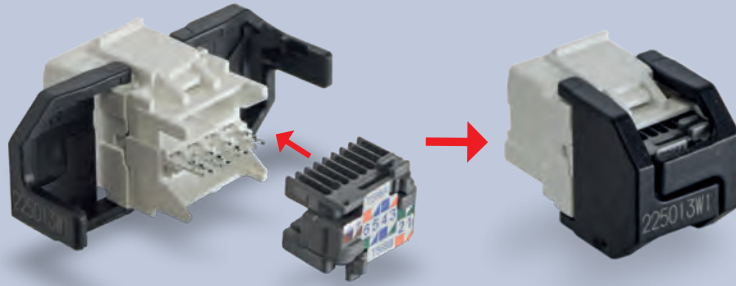

Non necessita di apposito attrezzo per i conduttori  
The special tool for conductors is not required

Caratteristiche Tecniche Technical Features

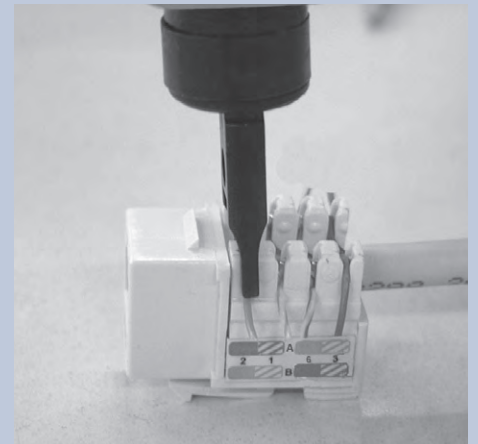

Connettori Ave, usare l'apposito attrezzo per premere i conduttori  
Ave connectors, use the special tool to press the conductors

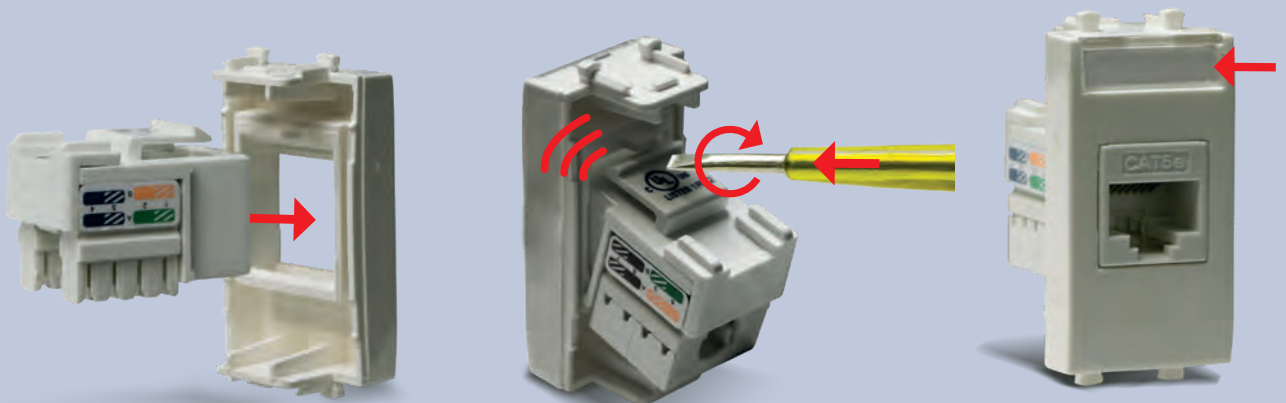

Aggancio  
Coupling

Sgancio  
Uncoupling

Cartellino identificativo  
Identification card

Per la disponibilità contattare la rete commerciale  
For availability please contact sales dept.

Disponibilità fino ad esaurimento scorte  
Available until stock out

# Prodotto per scatola rettangolare inglese  
Product for British standard rectangular box

△ Prodotto per Export  
For Export only



Prese dati  
Data socket outlets

Whitek	Tekla	Descrizione Description	Info	€	<input type="checkbox"/>	<input type="checkbox"/>
		<input type="checkbox"/> 446027C5E <input checked="" type="checkbox"/> 445027C5E Presa RJ45 categoria 5 enhanced - non schermata - morsetti ad incisione d'isolante - cablaggio universale T568A e T568B - 8 contatti - 1 modulo <i>RJ45 category 5 enhanced outlet - not shuttered - insulation piercing terminals - T568A and T568B universal wiring - 8 contacts - 1 module</i>		12,26	1	10
446027C5E	445027C5E	<input type="checkbox"/> 446027C6 <input checked="" type="checkbox"/> 445027C6 Presa RJ45 categoria 6 - non schermata - connettore AVE - morsetti ad incisione d'isolante - cablaggio universale T568A e T568B - 8 contatti - 1 modulo <i>RJ45 category 6 outlet - not shuttered - AVE connector - insulation piercing terminals - T568A and T568B universal wiring - 8 contacts - 1 module</i>		14,76	1	10
		<input type="checkbox"/> 446027C7S <input checked="" type="checkbox"/> 445027C7S Presa RJ45 categoria 7 - schermata - connettore AVE - morsetti ad incisione d'isolante - cablaggio universale T568A e T568B - 8 contatti - 1 modulo <i>RJ45 category 7 outlet - shuttered - AVE connector - insulation piercing terminals - T568A and T568B universal wiring - 8 contacts - 1 module</i>		23,11	1	10
446027C6	445027C6	<input type="checkbox"/> 446029C5E <input checked="" type="checkbox"/> 445029C5E Presa RJ45 categoria 5 enhanced - non schermata - connettore 3M - morsetti ad incisione d'isolante con cablaggio rapido - cablaggio universale T568A e T568B - 8 contatti - sportellino antipolvere integrato nel connettore - 1 modulo <i>RJ45 category 5 enhanced outlet - not shuttered - 3M connector - insulation piercing terminals with rapid wiring - T568A and T568B universal wiring - 8 contacts - anti-dust lid integrated in the connector - 1 module</i>		24,91	1	10
		<input type="checkbox"/> 446029C6 <input checked="" type="checkbox"/> 445029C6 Presa RJ45 categoria 6 - non schermata - connettore 3M - morsetti ad incisione d'isolante con cablaggio rapido - cablaggio universale T568A e T568B - 8 contatti - sportellino antipolvere integrato nel connettore - 1 modulo <i>RJ45 category 6 outlet - not shuttered - 3M connector - insulation piercing terminals with rapid wiring - T568A and T568B universal wiring - 8 contacts - anti-dust lid integrated in the connector - 1 module</i>		26,19	1	10
446027C7S	445027C7S	<input type="checkbox"/> 446029C6S <input checked="" type="checkbox"/> 445029C6S Presa RJ45 categoria 6 - schermata - connettore 3M - morsetti ad incisione d'isolante con cablaggio rapido - cablaggio universale T568A e T568B - 8 contatti - sportellino antipolvere integrato nel connettore - 1 modulo <i>RJ45 category 6 outlet - shuttered - 3M connector - insulation piercing terminals with rapid wiring - T568A and T568B universal wiring - 8 contacts - anti-dust lid integrated in the connector - 1 module</i>		31,74	1	10
		<input type="checkbox"/> 446029C6S <input checked="" type="checkbox"/> 445029C6AS Presa RJ45 categoria 6a FTP - schermata - morsetti ad incisione d'isolante con cablaggio rapido - cablaggio universale T568A e T568B - 8 contatti - sportellino antipolvere integrato nel connettore - 1 modulo <i>RJ45 category 6a FTP outlet - shuttered - AVE connector - insulation piercing terminals with rapid wiring T568A and T568B universal wiring - 8 contacts - anti-dust lid integrated in the connector - 1 module</i>		29,89	1	10
446029C5E 446029C6	445029C5E 445029C6	<b>Nota:</b> previsto, nella parte superiore, vetrino trasparente e relativo cartellino per consentire all'installatore/utente l'identificazione del tipo di presa <b>Note:</b> on the upper part there is a transparent glass with card to allow the installer/user to identify the outlet type				
446029C6S	445029C6S					
446029C6AS	445029C6AS					

Adattatori per connettori RJ45 e connettori di segnale AVE Adaptors for RJ45 connectors and AVE signal connectors

Whitek	Tekla	Descrizione Description	Info	€	<input type="checkbox"/>	<input type="checkbox"/>
		<input type="checkbox"/> 446029SC <input checked="" type="checkbox"/> 445029SC Adattatore per connettori RJ45 3M, AT&T, CEAM-QUBIX, KRONE, CLIPSAL, AMPHENOL, FANTON o connettori AVE RJ11, RJ45, RCA, TV, ecc. - 1 modulo <i>Adaptor for RJ45 3M, AT&amp;T, CEAM-QUBIX, KRONE, CLIPSAL, AMPHENOL, FANTON or AVE RJ11, RJ45, RCA, TV, etc. connectors - 1 module</i>		6,35	4	4
446029SC	445029SC	<input type="checkbox"/> 446030SC <input checked="" type="checkbox"/> 445030SC Adattatore per connettori RJ45 AMP, RSX, BRAND-REX - 1 modulo <i>Adaptor for RJ45 AMP, RSX, BRAND-REX connectors - 1 module</i>		6,35	4	4
		<input checked="" type="checkbox"/> 445029SC/2C Adattatore per n° 2 connettori AVE TV, RCA, BNC, USB, HDMI - 1 modulo <i>Adaptor for n. 2 AVE TV, RCA, BNC, USB, HDMI connectors - 1 module</i>		6,56	4	4
446030SC	445030SC					

Le dimensioni, salvo diversamente specificato, sono in mm  
Dimensions, except where otherwise specified, are in mm

Imballo Minimo pcs  
Min. Packaging pcs

Imballo Standard pcs  
Std. Packaging pcs

Sistema 45



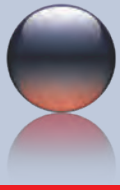

# Serie WHITEK - TEKLA

WHITEK - TEKLA series



Prese TV/SAT  
TV/SAT socket outlets

Caratteristiche Tecniche Technical Features

### Prese TV passanti Through line TV outlet

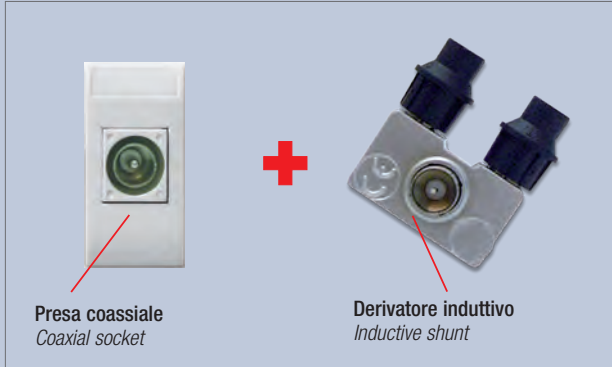

### Vista laterale Side view

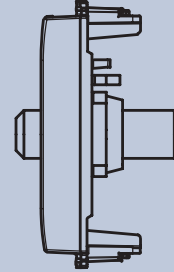

### Applicazione etichetta adesiva per diversificazione TV/SAT Domus Application of sticky label for diversification Domus TV/SAT



### Applicazione cartellino per diversificazione TV/SAT Tekla Application of the card to diversify Tekla TV/SAT

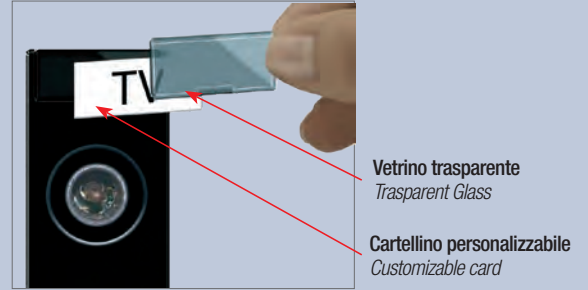

### CAP

#### Collegamento Connection

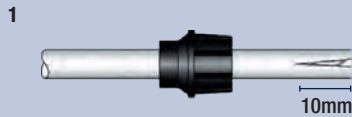

Taglio trasversale guaina  
Cross cut on sheath

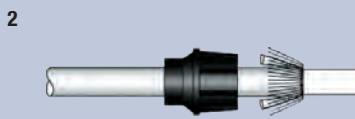

Ripiegamento calza  
Fold back braiding

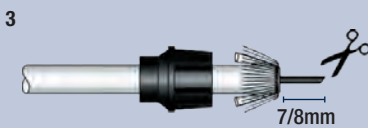

Taglio del dielettrico e del conduttore centrale a 45°  
45° cut of the dielectric and central conductor

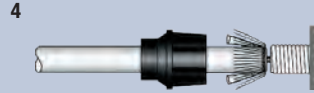

Inserzione conduttore centrale su connettore F femmina  
Insert central conductor on F-type female connector

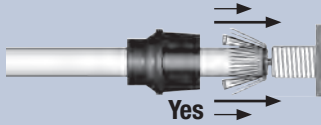
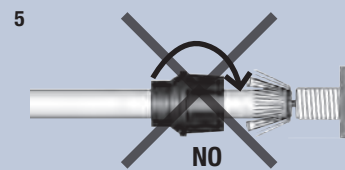

Inserzione CAP (non avvitando)  
Insert CAP (do not screw)

#### Estrazione Extraction

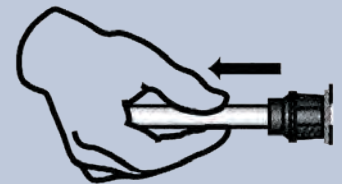

NO

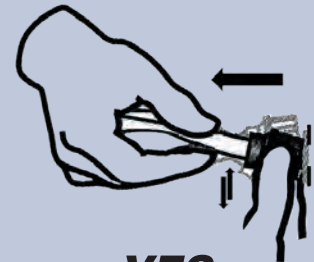

YES



Per la disponibilità contattare la rete commerciale  
For availability please contact sales dept.



Disponibilità fino ad esaurimento scorte  
Available until stock out



Prodotto per scatola rettangolare inglese  
Product for British standard rectangular box



Prodotto per Export  
For Export only

Prese TV/SAT con CAP - Ø 9,5 mm - Accessori  
TV/SAT socket outlets - Ø 9,5 mm - Accessories

Whitek	Tekla	Descrizione Description	Info	€	□	□
		<p>□ 446096IM    ■ 445096IM</p> <p>Presse coassiale TV/SAT diretta con porta utente IEC 60169-2 maschio per frequenze fino a 2400 MHz - collegamento in ingresso mediante connettore maschio tipo F - fornita con connettore plastico (CAP) per la connessione in ingresso del cavo coassiale - fornita con etichette adesive TV/SAT - 1 modulo</p> <p><i>TV/SAT direct coaxial socket with IEC 60169-2 male connector for frequencies until 2400 MHz - incoming connection through F male connector - supplied with plastic connector (CAP) for coaxial cable connection - supplied with sticky labels TV/SAT - 1 module</i></p>		12,35	1	12
		<p>□ 446096F    ■ 445096F</p> <p>Presse coassiale TV/SAT diretta con porta utente femmina tipo F per frequenze fino a 2400 MHz - collegamento in ingresso e in uscita mediante connettore maschio tipo F - fornita con connettore plastico (CAP) per la connessione in ingresso del cavo coassiale - fornita con etichette adesive TV/SAT - 1 modulo</p> <p><i>TV/SAT direct coaxial socket with F female connector for frequencies until 2400 MHz - incoming and outgoing connection through F male connector - supplied with plastic connector (CAP) for coaxial cable connection - supplied with sticky labels TV/SAT - 1 module</i></p>		12,67	1	12
		<p>□ 446096IF    ■ 445096IF</p> <p>Presse coassiale TV/SAT diretta con porta utente IEC 60169-2 femmina per frequenze fino a 2400 MHz - collegamento in ingresso mediante connettore maschio tipo F - fornita con connettore plastico (CAP) per la connessione in ingresso del cavo coassiale - fornita con etichette adesive TV/SAT - 1 modulo</p> <p><i>TV/SAT direct coaxial socket with IEC 60169-2 female connector for frequencies until 2400 MHz - incoming connection through F male connector - supplied with plastic connector (CAP) for coaxial cable connection - supplied with sticky labels TV/SAT - 1 module</i></p>		12,70	2	12
		<p>□ 446096DM    ■ 445096DM</p> <p>Presse TV - SAT diretta demiscelata, 2 uscite con connettore maschio (TV) e connettore tipo F (SAT) - per frequenze 5-2400 MHz - attenuazione di derivazione 1dB - permette il passaggio di corrente continua e segnali di controllo (24V 500mA max) - collegamento in ingresso mediante morsetto a vite - 1 modulo</p> <p><i>TV/SAT demixed direct socket, 2-outputs with male connector (TV) and type F (SAT) connector - for frequencies 5-2400 MHz - attenuation 1dB - it allows the passage of direct current and control signals (24V 500mA max) - incoming connection with screw terminal - 1 module</i></p>		30,18	1	1
		<p><b>TVDER-DB6</b></p> <p>Derivatore induttivo TV/SAT ad innesto su presa 44..096IM, 44..096IF, 44..096F - attenuazione di derivazione 6dB</p> <p><i>TV/SAT inductive shunt to be connected to 44..096IM, 44..096IF, 44..096F - attenuation 6dB</i></p>		10,31	1	6
		<p><b>TVDER-DB10</b></p> <p>Derivatore induttivo TV/SAT ad innesto su presa 44..096IM, 44..096IF, 44..096F - attenuazione di derivazione 10dB</p> <p><i>TV/SAT inductive shunt to be connected to 44..096IM, 44..096IF, 44..096F - attenuation 10dB</i></p>		10,09	1	6
		<p><b>TVDER-DB14</b></p> <p>Derivatore induttivo TV/SAT ad innesto su presa 44..096IM, 44..096IF, 44..096F - attenuazione di derivazione 14dB</p> <p><i>TV/SAT inductive shunt to be connected to 44..096IM, 44..096IF, 44..096F - attenuation 14dB</i></p>		10,09	1	6



TVDER-DB6  
TVDER-DB10  
TVDER-DB14

**Nota:** TVDER-DB... permettono la trasformazione delle prese 44..096IM, 44..096IF, 44..096F da dirette a passanti  
**Note:** TVDER-DB... allow to change the 44..096IM, 44..096IF, 44..096F sockets from direct to through line

Presse TV/SAT Ø 9,5 mm TV/SAT socket outlet Ø 9,5 mm

Whitek	Tekla	Descrizione Description	Info	€	□	□
		<p>□ 446096FE    ■ 445096FE</p> <p>Presse TV femmina IEC 60169-2 - per frequenze 4÷2400 MHz - collegamento in ingresso mediante morsetto a vite - 1 modulo</p> <p><i>Female TV socket IEC 60169-2 - for frequencies 4÷2400 MHz - input connection through screw terminals - 1 module</i></p>	△	6,10	10	10



# Serie WHITEK - TEKLA

WHITEK - TEKLA series



Presse TV/SAT Ø9,5 mm  
TV/SAT socket outlet Ø 9,5 mm

64

Whitek  Tekla **Descrizione Description** **Info** € □ □



446096M/DB6  
446096M/DB10



445096M/DB6  
445096M/DB10

□ 446096M/DB6 ■ 445096M/DB6

Presse TV/SAT passante con porta utente IEC 60169-2 maschio - per frequenze 4÷2400 MHz - attenuazione di derivazione 6dB - collegamento in ingresso mediante morsetto a vite - 1 modulo  
*Through-line TV/SAT outlet with male IEC 60169-2 connector - for frequencies 4÷2400 MHz - attenuation 6dB - input connection through screw terminal - 1 module*

26,98 1 1

□ 446096M/DB10 ■ 445096M/DB10

Presse TV/SAT passante con porta utente IEC 60169-2 maschio - per frequenze 4÷2400 MHz - attenuazione di derivazione 10dB - collegamento in ingresso mediante morsetto a vite - 1 modulo  
*Through-line TV/SAT outlet with male IEC 60169-2 connector - for frequencies 4÷2400 MHz - attenuation 10dB - input connection through screw terminal - 1 module*

26,98 1 1

Presse TV/SAT Ø 9,5 mm TV/SAT socket outlet Ø 9,5 mm

Whitek  Tekla **Descrizione Description** **Info** € □ □



446096M



445096M

□ 446096M ■ 445096M

Presse TV/SAT diretta con porta utente IEC 60169-2 maschio - per frequenze 4÷2400 MHz - attenuazione di derivazione 1dB - permette il passaggio di corrente continua e segnali di controllo (24V 300mA max) - collegamento in ingresso mediante morsetto a vite - fornita con etichette adesive TV/SAT - 1 modulo  
*Direct TV/SAT socket with male IEC 60169-2 connector - for frequencies 4÷2400 MHz - attenuation 1dB - it allows the passage of direct current and control signals (24V 300mA max) input connection through screw terminals -supplied with TV/SAT adhesive labels - 1 module*

18,60 1 10

Presse TV/SAT con 2 e 3 porte utente TV/SAT socket outlets with 2 and 3 connectors

**Tekla** **Descrizione Description** **Info** € □ □



445096/3PU

■ 445096/3PU

Presse TV-FM-SAT diretta - demiscelata - 3 porte utente con connettore TV IEC 60169-2 maschio, connettore radio IEC 60169-2 femmina, connettore SAT tipo F femmina - per frequenze 4÷2400 MHz - attenuazione di derivazione 1dB - permette il passaggio di corrente continua e segnali di controllo (24V 300mA max) attraverso il connettore F femmina - collegamento in ingresso mediante morsetto a vite - 2 moduli  
*Direct TV-FM/SAT - demixed triplex socket with IEC 60169-2 male TV connector, IEC 60169-2 female radio connector and SAT female F-type connector - frequency range 4÷2400 MHz - Attenuation 1dB - it allows the passage of direct current and control signals (24V 300mA max) through the female F-type connector - incoming connection with screw terminal - 2 modules*

63,47 1 6

**Nota:** 44..096/3PU per un ottimale funzionamento della presa tutte le uscite devono essere utilizzate

**Note:** 44..096/3PU for a perfect functioning of the socket, all the connectors must be used



Per la disponibilità contattare la rete commerciale  
For availability please contact sales dept.



Disponibilità fino ad esaurimento scorte  
Available until stock out



Prodotto per scatola rettangolare inglese  
Product for British standard rectangular box



Prodotto per Export  
For Export only

## Interruttori automatici magnetotermici 120-230V~ MCB 120-230V~

Whitek	Tekla	Descrizione Description	Info	€	□ □
		<input type="checkbox"/> 446052X6 <input checked="" type="checkbox"/> 445052X6 Interruttore automatico magnetotermico 1P+N 6A 120-230V~ p.i. 1,5kA potenza dissipata 1,2W - 1 modulo <i>MCB 1P+N 6A 120-230V~ b.c. 1,5kA - dissipated power 1,2W - 1 module</i>	70,19	1	10
446052X6	445052X6	<input type="checkbox"/> 446052X10 <input checked="" type="checkbox"/> 445052X10 Interruttore automatico magnetotermico 1P+N 10A 120-230V~ p.i. 3kA potenza dissipata 1W - 1 modulo <i>MCB 1P+N 10A 120-230V~ b.c. 3kA - dissipated power 1W - 1 module</i>	72,32	1	10
		<input type="checkbox"/> 446052X16 <input checked="" type="checkbox"/> 445052X16 Interruttore automatico magnetotermico 1P+N 16A 120-230V~ p.i. 3kA potenza dissipata 2,1W - 1 modulo <i>MCB 1P+N 16A 120-230V~ b.c. 3kA dissipated power 2,1W - 1 module</i>	72,96	1	10
446052X10	445052X10	<b>Note:</b> magnetotermici curva C <b>Note:</b> MCB type C			
446052X16	445052X16				

65

Sistema 45

## Interruttori automatici magnetotermici differenziali 120-230V~ SRCBO 120-230V~

Whitek	Tekla	Descrizione Description	Info	€	□ □
		<input checked="" type="checkbox"/> 445062X6 Interruttore automatico magnetotermico differenziale 1P+N 6A 120-230V~ $I_{\Delta n}$ 10mA p.i. 1,5kA - potenza dissipata 1,3W - 2 moduli <i>SRCBO 1P+N 6A 120-230V~ <math>I_{\Delta n}</math> 10mA b.c. 1,5kA - dissipated power 1,3W - 2 modules</i>	167,43	1	6
	445062X6	<input type="checkbox"/> 446062X10 <input checked="" type="checkbox"/> 445062X10 Interruttore automatico magnetotermico differenziale 1P+N 10A 120-230V~ $I_{\Delta n}$ 10mA p.i. 3kA - potenza dissipata 1,1W - 2 moduli <i>SRCBO 1P+N 10A 120-230V~ <math>I_{\Delta n}</math> 10mA b.c. 3kA - dissipated power 1,1W - 2 modules</i>	167,43	1	6
		<input type="checkbox"/> 446062X16 <input checked="" type="checkbox"/> 445062X16 Interruttore automatico magnetotermico differenziale 1P+N 16A 120-230V~ $I_{\Delta n}$ 10mA p.i. 3kA - potenza dissipata 2,5W - 2 moduli <i>SRCBO 1P+N 16A 120-230V~ <math>I_{\Delta n}</math> 10mA b.c. 3kA - dissipated power 2,5W - 2 modules</i>	184,37	1	6
446062X10	445062X10	<b>Note:</b> ✓ prevedono una segnalazione frontale di alimentazione e contatto chiuso a mezzo led colore verde ✓ magnetotermici curva C - differenziali tipo A <b>Notes:</b> ✓ frontal signal of power supply and closed contact through a green led ✓ MCB type C - SRCBO type A			
446062X16	445062X16				

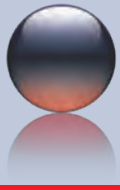

# Serie WHITEK - TEKLA

WHITEK - TEKLA series



Relè di chiamata  
Call Relays

## Schema di Collegamento 44..087C Connection Diagram 44..087C

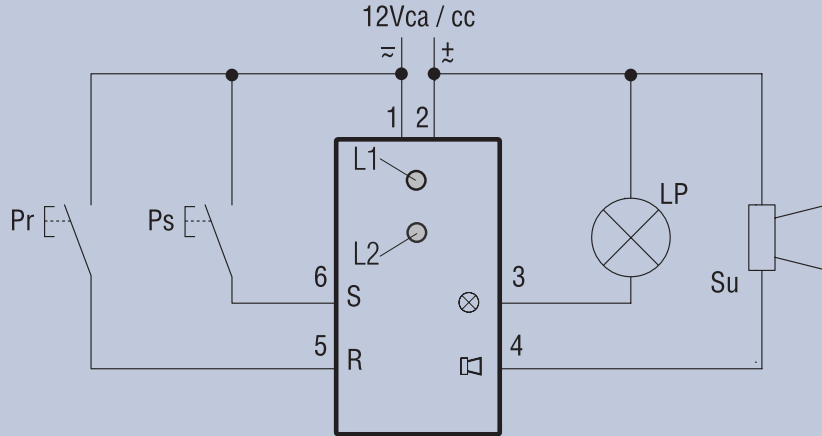

**Nota:** ✓ per il corretto funzionamento del relè è necessario prevedere un trasformatore 12 Vca oppure un alimentatore 12 Vcc opportunamente dimensionati  
 ✓ se il relè è alimentato in corrente alternata la tensione efficace sui carichi (lampada e suoneria) è pari alla metà della tensione di alimentazione

**Note:** ✓ for the proper functioning of the relay it is necessary to provide a transformer 12 Vac or a power supply 12 Vdc appropriately sized  
 ✓ If the relay is powered in alternating current, the RMS voltage on the loads (lamp and sounder) is equal to the half of powering voltage.

## Relè di Chiamata - Sistema di Chiamata Call Relay - Call System

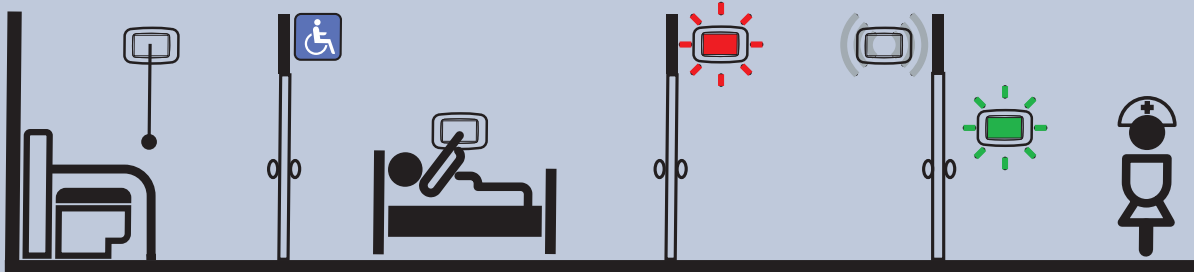

Il paziente agendo sul pulsante effettua una chiamata. Il relè attiva le segnalazioni ottiche ed acustiche nel corridoio e la segnalazione ottica in reception corrispondente al numero del chiamante

*By pressing a push button the patient makes a call. The relay activates the visual and sound signals in the corridor and the visual signal at reception corresponding to the caller's number*



L'infermiera intervenendo nella camera del paziente effettua l'azione di reset agendo sul pulsante posto nella camera stessa, annullando l'attivazione delle segnalazioni ottiche ed acustiche

*The nurse is summoned to the patient's room and can reset by pressing the push-button in the room, cancelling the visual and sound signals.*

Caratteristiche Tecniche Technical Features



Per la disponibilità contattare la rete commerciale  
 For availability please contact sales dept.



Disponibilità fino ad esaurimento scorte  
 Available until stock out





Prodotto per scatola rettangolare inglese  
 Product for British standard rectangular box



Prodotto per Export  
 For Export only



## Relè di chiamata Call Relays

Whitek	Tekla	Descrizione Description	Info	€	□	□
		<b>□ 446087C</b> <b>■ 445087C</b> Relè statico bistabile (tipo Flip-Flop SR) 12Vca/cc per impianti di chiamata - 2 uscite: per segnalazione ottica (lampeggiante o fissa) e per segnalazione acustica (suono continuo o temporizzato da 3 secondi a 1 minuto) - attivazione e tacitazione da più punti con normali pulsanti NA collegati in parallelo - 1 modulo <i>Static bistable relay (type Flip-Flop SR) 12Vca/cc for call systems - 2 outputs: for visual signals (flashing or fixed) and acoustic signals (continuous sound or at intervals of 3 seconds to 1 minute) - activated and silenced from various points using normal NO push buttons connected in parallel - 1 module</i>		143,58	1	1
446087C	445087C	<b>KITCHIAMATEKLA</b> Kit base per sistema di chiamata d'emergenza La confezione contiene: - n° 1 445087C relè per impianti di chiamata 12Vca/cc; - n° 1 445081 segnalatore ausiliario d'allarme 86dB 12÷24Vca/cc; - n° 1 445082ALI alimentatore 230Vca/12Vcc 5W; - n° 1 442076 spia di segnalazione sporgente (lampadina esclusa); - n° 1 0212LDW/E10HI lampada a led con fili 12-24Vca/cc (per art. 441050); - n° 1 445050 pulsante 1P NA 10A con scritta "RESET" sull'etichetta di segnalazione; - n° 1 445017 pulsante 1P NA+NC 10A a tirante; - n° 3 44A03 supporti con viti per scatole rettangolari 3 moduli <i>Basic kit for emergency call</i> The package includes: - n° 1 445087C static bistable relay - n° 1 445081 auxiliary alarm signal - n° 1 445082ALI flush mounted power supply - n. 1 442076 prominent lamp holder (bulb excluded); - n. 1 0212LDW/E10HI led signalling lamp with wires 12-24Vca/cc (for art. 441050); - n° 1 445050 1P NO 10A 250V lightable push-button "RESET" label on the diffuser - n° 1 445017 1P NO+NC 10A cord operated push-button - n° 3 44A03 frame with screws for rectangular box		346,20	1	1



KITCHIAMA...

Integrabili nel Sistema  
Can be integrated with the system



**Note:** per ulteriori informazioni vedere paragrafo "suonerie elettroniche"

**Notes:** for further information, see the "electronic ringtones" paragraph



Sistema 45







# Serie WHITEK - TEKLA

WHITEK - TEKLA series









Suonerie / Ronzatori elettromeccanici  
Bells / Buzzers

68

Whitek	 Tekla	Descrizione Description	Info	€	□	□
 446028 446029	 445028 445029	<input type="checkbox"/> 446028 <input checked="" type="checkbox"/> 445028 Suoneria squillante 12V~ 8VA (SELV) - 1 modulo <i>Ringling bell 12V~ 8VA (SELV) - 1 module</i>		27,55	1	10
		<input type="checkbox"/> 446029 <input checked="" type="checkbox"/> 445029 Suoneria squillante 230V~ - 1 modulo <i>Ringling bell 230V~ - 1 module</i>		33,62	1	10
		<input type="checkbox"/> 446030 <input checked="" type="checkbox"/> 445030 Ronzatore 12V~ 8VA (SELV) - 1 modulo <i>Buzzer 12V~ 8VA (SELV) - 1 module</i>		21,37	1	10
 446030 446031	 445030 445031	<input type="checkbox"/> 446031 <input checked="" type="checkbox"/> 445031 Ronzatore 230V~ - 1 modulo <i>Buzzer 230V~ - 1 module</i>		27,77	1	10

**Nota:** Utilizzare solo per servizio ad intermittenza. Tempo massimo di utilizzo continuo 5" con relativa pausa di 15"  
*Note: Use only for intermittent service. Maximum time of continuous use 5 " with relative pause of 15"*

## Suonerie elettroniche Electronic bells

Whitek	 Tekla	Descrizione Description	Info	€	□	□
 446081	 445081	<input type="checkbox"/> 446081 <input checked="" type="checkbox"/> 445081 Segnalatore ausiliario d'allarme con possibilità di temporizzazione suoneria per 5 secondi - alimentazione 12-24 Vcc/ca - possibilità regolazione intensità sonora - pressione acustica 86 dB a 1m - led frontale di segnalazione - 1 modulo <i>Auxiliary alarm signal - possibility of setting a timer to ring for 5 second-12s depending on input voltage- input 12-24 Vac/dc - it is possible to adjust the sound volume - acoustic pressure 85 dB at 1m - front signalling led - 1 module</i>		62,08	1	10
		<input checked="" type="checkbox"/> 445083/2 Suoneria elettronica tritonale - alimentazione 12 Vcc/ca - possibilità di scelta tra sei diversi suoni acustici - regolazione frontale intensità sonora - led frontale di segnalazione - pressione acustica 71÷76 dB a 1 m a seconda del suono attivato - 2 moduli <i>Three tone electronic bell - 12 Vac/dc power supply - possibility to choose one out of six acustics tones - frontal sound regulation - frontal signalling led - acoustic pressure 71÷76 dB at 1 m according to the sound activated - 2 modules</i>		120,11	1	6
	 445083/2	<input checked="" type="checkbox"/> 441083/2RS Suoneria tritonale 12vcc per sistemi chiamata di emergenza colore rosso - assorbimento 160mA - possibilità scelta tra 3 tipologie di segnalazioni acustiche temporizzate che identificano le seguenti chiamate: <b>GENERICA - EMERGENZA - ALLARME</b> - regolazione frontale intensità sonora da 45 a 65 dB - led frontale - 2 moduli <i>12Vdc sounders for emergency call systems, red colour - 160mA absorption - Three different timed sound time options identifying following calls: <b>GENERIC - EMERGENCY - ALARM</b> - frontal trimmer for sound pressure adjustment from 45 to 65 dB - frontal led - 2 modules</i>		118,09	1	1
 AF442099RS	 441083/2RS	<input checked="" type="checkbox"/> AF442099RS Sirena da interni rossa per sistemi antifurto o avvisatore acustico - alimentazione 12 Vcc - possibilità di impostazione di due livelli di intensità sonora - possibilità di scelta tra quattro diversi suoni acustici - pressione acustica 90 dB a 3 m - 2 moduli <i>Indoor siren for burglar alarm systems or acoustical device - 12 Vdc - power supply - possibility to set two different levels of acoustic intensity - possibility to choose among four different acoustic sounds - acoustic pressure 90 dB at 3m - 2 modules</i>		78,96	1	1



Per la disponibilità contattare la rete commerciale  
For availability please contact sales dept.



Disponibilità fino ad esaurimento scorte  
Available until stock out





Prodotto per scatola rettangolare inglese  
Product for British standard rectangular box



Prodotto per Export  
For Export only

## Portafusibili 250V~ Fuse Holders 250V~

Whitek	Tekla	Descrizione Description	Info	€	<input type="checkbox"/>	<input type="checkbox"/>
 446007	 445007	<p><input type="checkbox"/> 446007    <input checked="" type="checkbox"/> 445007</p> <p>Portafusibile per fusibili in miniatura 1P 10A - per fusibili Ø 5x20 mm - fornito senza fusibile - 1 modulo  <i>Fuse holder for miniature fuses 1P 10A - for fuses Ø 5x20 mm - supplied without fuse - 1 module</i></p>		14,95	1	10

69

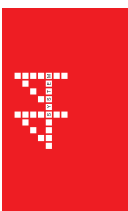

Sistema 45

## Alimentatori Power supplies

Whitek	Tekla	Descrizione Description	Info	€	<input type="checkbox"/>	<input type="checkbox"/>
	 445082ALI	<p><input checked="" type="checkbox"/> 445082ALI</p> <p>Alimentatore supplementare da incasso - tensione di ingresso: 85÷265V~ 50-60Hz - tensione d'uscita 12 Vcc - corrente erogabile: 400mA a servizio continuo - 1 modulo  <i>Additional flush mounted power supply - input voltage 85÷265V~ 50-60Hz - output voltage 12 Vdc - suppliable current: 400mA continuous - 1 module</i></p>		76,75	1	1

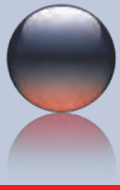

# Serie WHITEK - TEKLA

WHITEK - TEKLA series

Lampade  
Lights



Caratteristiche Tecniche Technical Features

## Lampade estraibili 44..086 Removable lights 44..086

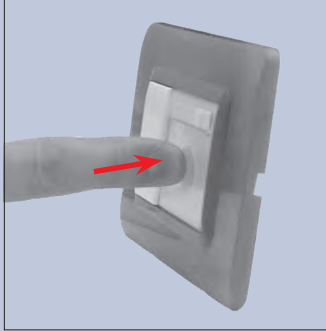

Estrazione lampada: premere sul fronte  
Light removal: push on the front

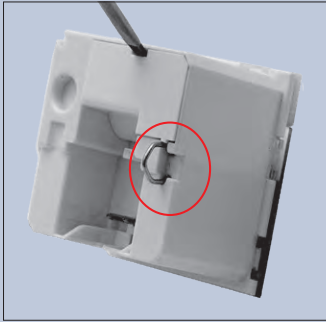
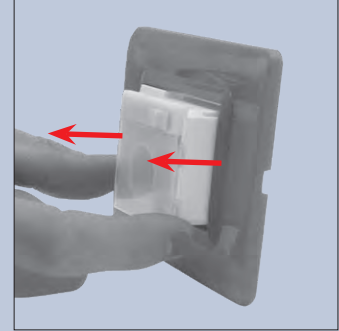
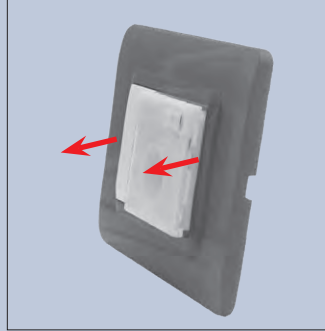

Gancio appendi-lampada  
Light clipping hook

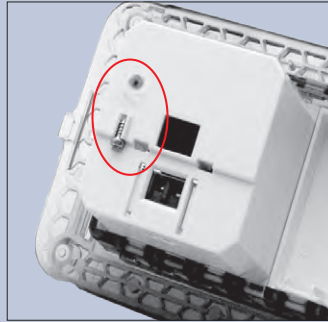

Vite per blocco estrazione lampada  
Light anti-removal screw

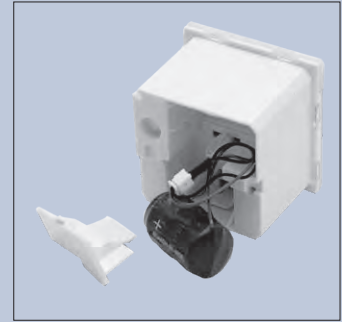

Sostituzione batteria  
Battery replacement

## Lampada di emergenza MULTICOMPATIBILE MULTI-COMPATIBLE emergency light

Installazione su scatole standard da 4 e 7 moduli  
Installation on 4 modules and 7 modules standard boxes

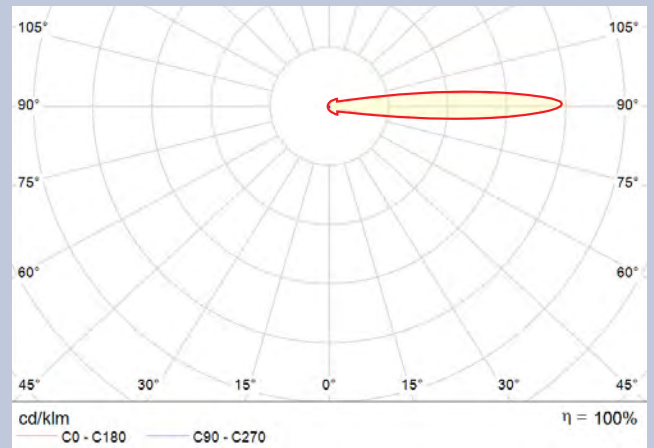

- Flusso luminoso 90 lumen
- Completa di supporto MULTICOMPATIBILE 6/7 moduli
- Installabile sia in scatole da incasso standard 6/7 moduli sia in 4 moduli
- Da completare con placche standard 7 moduli S44 di Ave o con analoghe placche di altri costruttori (Bticino Livinglight, Bticino Living International, Bticino Light, Vimar Eikon, Vimar Plana)
- placche Serie SMART NON INSTALLABILI
- Luminous flux 90 lumen
- Supplied with MULTICOMPATIBILE 6/7 modules frame
- It can be installed both in 6/7 modules standard flush mounted boxes and in 4 modules boxes
- To be completed with AVE S44, 7 mod front plates or with similar front plates by other manufacturers (Bticino Livinglight, Bticino Living International, Bticino Light, Vimar Eikon, Vimar Plana)
- SMART Series front plates NOT INSTALLABLE

Per la disponibilità contattare la rete commerciale  
For availability please contact sales dept.

Disponibilità fino ad esaurimento scorte  
Available until stock out





# Prodotto per scatola rettangolare inglese  
Product for British standard rectangular box

△ Prodotto per Export  
For Export only

## Lampada segnagrado e lampada estraibile portatile

### Step marker light and removable portable light

BREVETTO AVE N° 102  
MODELLO COMUNITARIO  
AVE PATENT N° 102

Whitek	Tekla	Descrizione Description	Info	€	□	□
		<b>□ 446070/1</b> <b>■ 445070/1</b> Lampada segnagrado - alimentazione 12-24 Vcc/ca o 230 V~ - led colore bianco ad alta efficienza - 1 modulo <i>Step marker light - input 12-24 Vac/dc o 230 V~ - white led, high efficiency - 1 module</i>		41,49	1	10
446070/1	445070/1	<b>□ 446086</b> <b>■ 445086</b> Lampada anti black-out estraibile portatile - completa di base di ricarica - completa di batterie ricaricabili e sostituibili - lampada: led colore bianco ad alta efficienza - interruttore frontale per spegnimento in assenza tensione di rete - tempo di ricarica 36 ore - autonomia 3 ore circa - alimentazione 110-230 V~ - 2 moduli <i>Anti black out removable portable light - with recharging base - with interchangeable and rechargeable batteries - lamp: high efficiency white led - front switch in case of power failure - 36 hours recharge time - 3 hours endurance - 110-230 V~ power supply - 2 module</i>		107,48	1	1
		<b>45786B</b> Batteria (4x1,2)V - 80mAh, di ricambio per 44..086 <i>Spare battery for 44..086 (4x1,2)V - 80mAh</i>		14,82	1	1
446086	445086					



45786B



Sistema 45

## Lampada di emergenza MULTICOMPATIBILE MULTI-COMPATIBLE emergency light

	Descrizione Description	Info	€	□	□
	<b>442089</b> Lampada di emergenza a LED bianchi ad alta efficienza 230 V~ 50/60 Hz - SE - assorbimento in stand-by 5 mA (340 mW) - batteria ricaricabile e sostituibile 3,7 V 700 mAh - tempo di ricarica 12 ore - autonomia 2 ore - autodiagnosi permanente della funzionalità della batteria con segnalazione luminosa in caso di anomalia - <b>flusso luminoso 90 lumen</b> - completa di supporto MULTICOMPATIBILE 6/7 moduli - <b>installabile sia in scatole da incasso standard 6/7 moduli sia in scatole 4 moduli</b> - da completare con placche standard 7 moduli S44 di Ave o con placche di altri costruttori (Bticino Livinglight, Bticino Living International, Bticino Light, Vimar Eikon, Vimar Plana) - <u>placche Serie SMART NON INSTALLABILI</u> - 4x7 moduli <i>Emergency light with a white high-efficiency LED 230 V ~ 50/60 Hz - N/M - absorption on stand-by 5 mA (340 mW) - Rechargeable and changeable battery: 3.7 V 700 mAh - Recharge time: 12 hours - 2 hours of endurance - permanent self-diagnosis of the battery functionality with warning light in case of failures - luminous flux 90 lumens - complete with MULTI-COMPATIBLE 6/7 modules frames - <b>installable in standard 6/7 modules flush mounted boxes or in 4 modules boxes</b> - to be completed with Ave S44 standard 7 modules front plates or plates from other manufacturers (Bticino Livinglight, Bticino Living International, BTicino Light, Vimar Eikon, Vimar Plana) - <u>SMART Series front plates NOT INSTALLABLE</u> - 4x7 modules</i>		109,97	1	1
442089	<b>442089B</b> Batteria Li-Ion 3,7 V 700 mAh di ricambio per lampada d'emergenza 442089 <i>Spare battery Li-Ion 3,7 V 700 mAh for emergency light 442089</i>		32,15	1	1

**Nota:** Non installabili le placche di finitura della Gamma Smart  
*Note: The Smart Range finishing front plates cannot be installed*



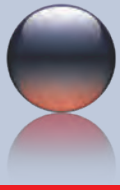

# Serie WHITEK - TEKLA

WHITEK - TEKLA series

Cronotermostato  
Chronothermostat



### MASSIME PRESTAZIONI per il RISPARMIO ENERGETICO:

- \* Differenziale termico minimo: vengono rilevate velocemente variazioni di temperatura in modo da evitare eccessive escursioni della temperatura ambiente controllata.
- \* Deriva sotto carico ridotta al minimo, ovvero la variazione tra la temperatura regolata quando il contatto del termostato è a vuoto e quando invece è a pieno carico elettrico.

### MAXIMUM PERFORMANCE for ENERGY SAVING:

- \* Minimum thermal differential: temperature variations are detected in order to avoid extreme room temperature oscillations
- \* Minimized on-duty offset, as to say the variation of the adjusted temperature between no load and full load operating conditions.

Caratteristiche Tecniche Technical Features



Ingresso comando da remoto  
Input for remote control

Contatto in scambio  
5A 250V  
switching  
contact 5A 250V

Tasti retro illuminati  
Backlighted controls

Set di temperatura al momento attivo a seconda del programma in corso:  
t1 Comfort o t2 Attività (precomfort) o t3 Economy (risparmio) o antigelo  
Temperature set currently active on the basis of the running program: T1 Comfort or T2 Activity (precomfort) or T3 Economy (saving) or antifreeze

Giorno, ora e minuti  
Day, hour and minutes

Completamente a filo placca  
Front plate levelness

Temperatura ambiente rilevata  
Detected room temperature

Scala oraria e termica programmata sulle 24 ore  
Hourly and thermal scale set up on 24 hours



Per la disponibilità contattare la rete commerciale  
For availability please contact sales dept.



Disponibilità fino ad esaurimento scorte  
Available until stock out







Prodotto per scatola rettangolare inglese  
Product for British standard rectangular box



Prodotto per Export  
For Export only

## Termostati Thermostats

Whitek	Tekla	Descrizione Description	Info	€	□	□
		<p><b>□ 446085</b>      <b>■ 445085</b></p> <p>Termostato elettronico a manopola per controllo temperatura ambiente - uscita con contatto in scambio NA+NC 5A (2A induttivi) 230V~ - range regolazione temperatura da 5 °C a 30 °C - alimentazione 230V~ 50-60 Hz - 2 moduli</p> <p><i>Electronic thermostat with rotary knob for room temperature control - switching contact output NO+NC 5A (2A inductive) - temperature range from 5 °C to 30 °C - 230V~ power supply - 50-60 Hz - 2 modules</i></p>	83,76	1	1	
		<p><b>□ 446085SW</b>      <b>■ 445085SW</b></p> <p>Termostato elettronico estate/inverno a display retroilluminato per controllo temperatura ambiente (riscaldamento e condizionamento) - uscita con contatto in scambio NA+NC 2A 230V~ - range regolazione temperatura da 0 °C a 35 °C - tasti di comando retroilluminati - ingresso per attivazione a distanza e ingresso per forzatura a temperatura ridotta - alimentazione 230V~ 50-60 Hz - 2 moduli</p> <p><i>Electronic winter/summer thermostat with backlit display for room temperature control (heating and air-conditioning) - switching contact output NO+NC 2A 230V~ - temperature range from 0 °C to 35 °C - backlit controls - input for remote activation and input for forcing at reduced temperature - 230V~ power supply - 50-60 Hz - 2 modules</i></p>	157,50	1	1	

## Cronotermostati 230V~ Chronothermostats 230V~

Whitek	Tekla	Descrizione Description	Info	€	□	□
		<p><b>□ 446CRT3</b>      <b>■ 445CRT3</b></p> <p>Cronotermostato elettronico da incasso a filo placca, con display retroilluminato per controllo temperatura ambiente (riscaldamento e condizionamento) - programmazione giornaliera/settimanale uscita con contatto in scambio libero da potenziale NA+NC 5A 250V~ - range regolazione temperatura da 5 °C a 37 °C. Set di programmazione per inibizione pulizie - 4 tasti di comando retroilluminati - ingresso per attivazione a distanza - passaggio automatico all'ora legale/solare - menù con guida testuale multilingue - alimentazione 230V~ 50-60 Hz - 3 moduli.</p> <p><i>Flush-mounted (front plate levelness) electronic chronothermostat with backlit display for room temperature control (heating and air-conditioning) - daily/weekly programming - switching contact output NO+NC 5A 250V~ temperature control range: from 5 °C to 37 °C - programming set for cleaning inhibition - 4 backlit controls - input for remote control - automatic passage to daylight saving/solar time - menu with multilingual text guide - 230V~ power supply - 50-60 Hz - 3 modules</i></p>	197,81	1	1	

## Variatore per agitatori d'aria Dimmer for ceiling fan

Whitek	Tekla	Descrizione Description	Info	€	□	□
		<p><b>■ 445048AA</b></p> <p>Variatore a 3 velocità (+ spegnimento) 55÷80VA 230V~ 50-60Hz- comando con pulsante incorporato o da più punti con normali pulsanti NA - tecnologia che garantisce l'assoluta "silenziosità" - led di individuazione al buio - 1 modulo</p> <p><i>3-speed push button dimmer (+ switch off) 55÷80VA 230V~ 50-60Hz- control by built-in push-button or by normal NO push-button from more points - technology guaranteeing absolute "silence" - led for identification in the dark - 1 module</i></p>	88,19	1	6	

## Commutatore per fan-coil Rotary switch for fan-coil

Whitek	Tekla	Descrizione Description	Info	€	□	□
		<p><b>■ 445055</b></p> <p>Commutatore rotativo 1P 3A 250V~ a 4 posizioni per variazione velocità fan-coil (ventilconvettori) - 2 moduli</p> <p><i>1P 3A 250V rotary switch 4 positions for fan coil (convectors) - 2 modules</i></p>	50,90	1	1	

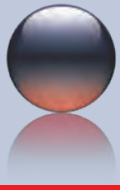

# Serie Domus - Class

Domus - Class series

Assiali  
Axial

Dimensione del modulo

Module dimension

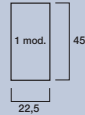

**Serie Domus**  
colore RAL 9010  
finitura LUCIDA

color RAL 9010  
POLISHED finish



**Serie Class**  
colore RAL 1013  
finitura LUCIDA

color RAL 1013  
POLISHED finish



### Comandi assiali

con i comandi assiali di nuova generazione è possibile attivare il carico premendo qualsiasi punto della superficie dei tasti. Una volta premuti ritornano in posizione restando sempre perfettamente allineati alla placca di finitura.

### Axial switches

by using the new generation axial controls it is possible to activate the load by pressing any point on the surface of the keys. Once pressed they return to position, always remaining perfectly aligned with the front plate.

Superficie del comando completamente chiusa per ridurre al minimo l'ingresso della polvere  
Fully enclosed control surface to minimize dust ingress

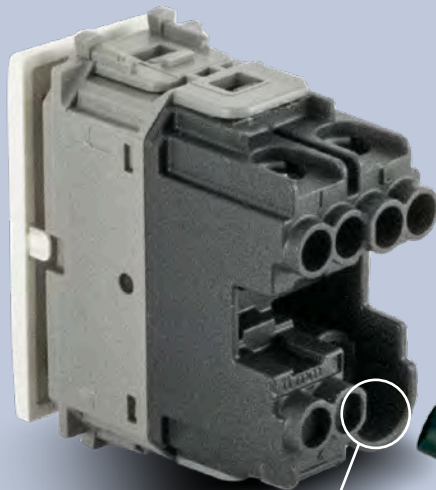

Inserimento lampadina di segnalazione  
Lamp insertion

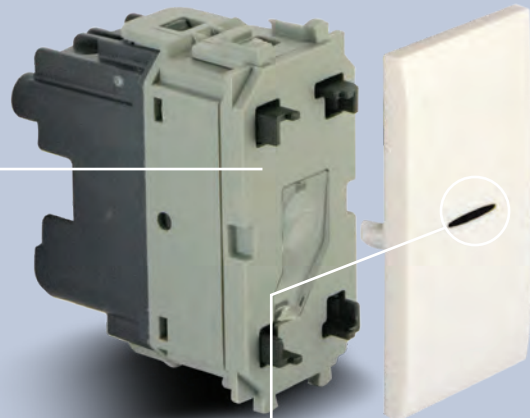

Consigliato l'utilizzo di lampada a led colore blu (cod. 0230LDB)  
It is recommended the use of blue colour led lamp (code 0230LDB)

Caratteristiche Tecniche Technical Features



Per la disponibilità contattare la rete commerciale  
For availability please contact sales dept.



Disponibilità fino ad esaurimento scorte  
Available until stock out





Prodotto per scatola rettangolare inglese  
Product for British standard rectangular box













Prodotto per Export  
For Export only









## Corpo Comando Assiali 250V~ Axial switches 250V~

Domus	Descrizione Description	Info	€	□	□	
 441001STAS	 441002STAS	 441005STAS	<p>□ 441001STAS Corpo interruttore assiale per tasti Domus e Class, 1P 10AX illuminabile-1 mod. <i>Axial switch body for Domus and Class rockers, 1P 10AX lighttable - 1 mod.</i></p> <p>□ 441002STAS Corpo deviatore assiale per tasti Domus e Class, 1P 10AX illuminabile-1 mod. <i>Axial two way switch body for Domus and Class rockers, 1P 10AX lighttable - 1 mod.</i></p> <p>□ 441005STAS Corpo pulsante assiale per tasti Domus e Class, 1P 10A illuminabile-1 mod. <i>Axial pushbutton body for Domus and Class rockers, 1P 10A lighttable - 1 mod.</i></p>	NEW	8,32	10 100
			NEW	9,79	10 100	
			NEW	9,80	10 100	

## Comandi Assiali Axial switches

Domus	Class	Descrizione Description	Info	€	□	□
 441001AS	 449001AS	<p>□ 441001AS    ■ 449001AS Interruttore assiale con gemma, 1P 10AX illuminabile - 1 mod. <i>Axial switch with gem, 1P 10AX lighttable - 1 mod.</i></p>	NEW	8,10	10 100	
 441010AS	 449010AS	<p>□ 441010AS    ■ 449010AS Interruttore bipolare assiale con gemma, 2P 10AX illuminabile - 1 mod <i>Axial bipolar switch with gem, 2P 10AX lighttable - 1 mod.</i></p>	NEW	19,83	10 100	
 441002AS	 449002AS	<p>□ 441002AS    ■ 449002AS Deviatore assiale con gemma, 1P 10AX illuminabile - 1 mod. <i>Axial two way switch with gem, 1P 10AX lighttable - 1 mod.</i></p>	NEW	9,67	10 100	
 441004AS	 449004AS	<p>□ 441004AS    ■ 449004AS Invertitore assiale con gemma, 1P 10AX illuminabile - 1 mod. <i>Axial intermediate switch with gem, 1P 10AX lighttable - 1 mod.</i></p>	NEW	19,83	10 100	
 441005AS	 449005AS	<p>□ 441005AS    ■ 449005AS Pulsante assiale con gemma, 1P 10A illuminabile - 1 mod. <i>Axial push-button with gem, 1P 10A illuminated - 1 mod.</i></p> <p><b>Nota:</b> forniti senza lampada di segnalazione <b>Note:</b> supplied without lamp</p>	NEW	9,84	10 100	

## Tasti intercambiabili assiali Interchangeable rockers axial

Domus	Class	Descrizione Description	Info	€	□	□
 441TKPAS	 449TKPAS	<p>□ 441TAS    ■ 449TAS Tasto intercambiabile con gemma per comandi assiali - 1 mod. <i>Interchangeable rocker with gem for axial controls - 1 mod.</i></p>	NEW	2,29	5 5	
 441TKPAS	 449TKPAS	<p>□ 441TKPAS    ■ 449TKPAS Tasto intercambiabile con simbolo chiave per comandi assiali - 1 mod. <i>Interchangeable rocker with key symbol for axial controls - 1 mod.</i></p>	NEW	3,12	5 5	
 441TLPAS	 449TLPAS	<p>□ 441TLPAS    ■ 449TLPAS Tasto intercambiabile con simbolo lampada per comandi assiali - 1 mod. <i>Interchangeable rocker with lamp symbol for axial controls - 1 mod.</i></p>	NEW	3,12	5 5	
 441TSPAS	 449TSPAS	<p>□ 441TSPAS    ■ 449TSPAS Tasto intercambiabile con simbolo suoneria per comandi assiali - 1 mod. <i>Interchangeable rocker with ringtone symbol for axial commands - 1 mod.</i></p>	NEW	3,12	5 5	



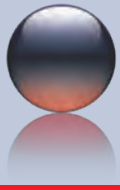

# Serie Domus - Class

Domus - Class series

Interruttori 250V~

One way switches 250V~

Dimensioni del modulo Module dimensions

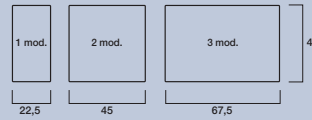

## Serie Domus colore RAL 9010 color RAL 9010



## Serie Class colore RAL 1013 color RAL 1013

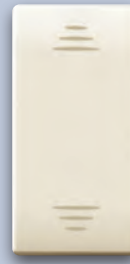

### Cacciaviti per comandi e prese di corrente *Screwdrivers for control devices and socket outlets*

Indicazioni per l'utilizzo di cacciaviti appropriati:

- tutti i prodotti elettromeccanici (interruttori, prese, supporti) sono dotati di viti con testa a croce che possono essere fissate con avvitatori automatici e manuali intaglio a croce PHILLIPS dimensione 2 e cacciavite a lama con larghezza max 5 mm e spessore max 0,8 mm.
- il momento torcente massimo non deve superare 1,8 Nm.

Information on use of suitable screwdrivers:

- all electromechanical products (switches, sockets and supports) are equipped with crosshead screws which can be fixed by automatic PHILLIPS screwdrivers size 2 and manual crosshead screwdrivers with max width 5 mm and max thickness 0,8 mm.
- maximum torque must not exceed 1.8 Nm

### Illuminazione Comandi *Controls Lighting*

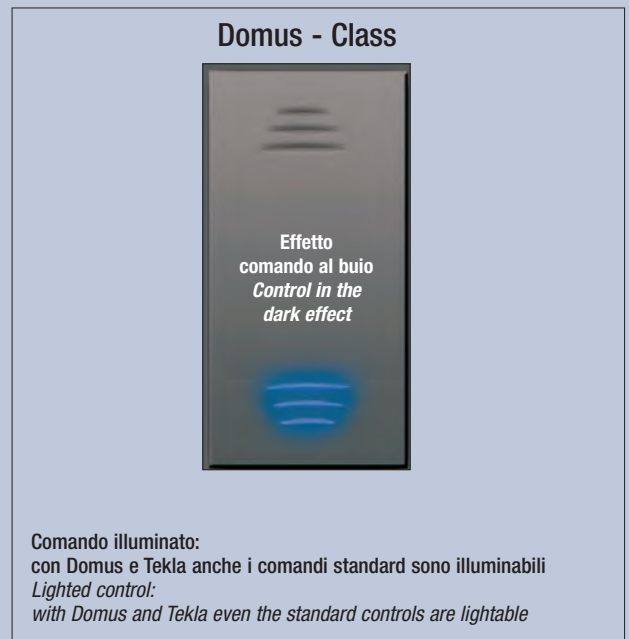
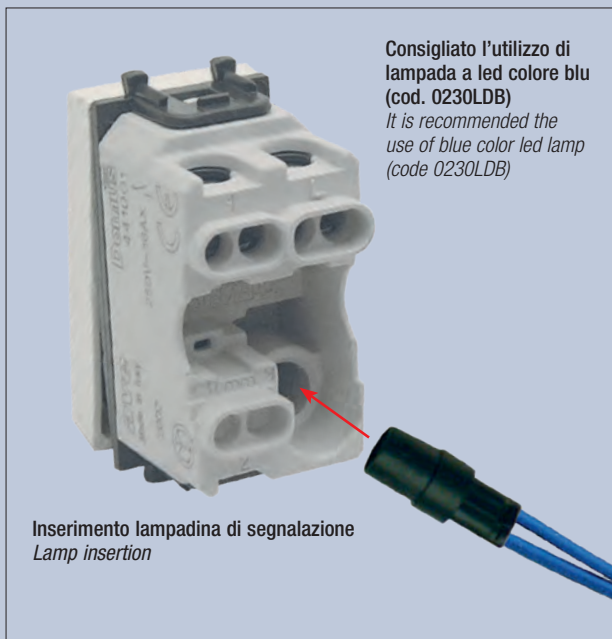

Per la disponibilità contattare la rete commerciale  
For availability please contact sales dept.



Disponibilità fino ad esaurimento scorte  
Available until stock out



















Prodotto per scatola rettangolare inglese  
Product for British standard rectangular box



Prodotto per Export  
For Export only

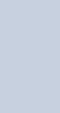

## Interruttori 250V~ One way switches 250V~

Domus	Class	Descrizione Description	Info	€	□ □
		□ <b>441001ST</b> Corpo interruttore 1P 16AX illuminabile da completare con tasto Domus o Class 1 o 2 mod.-1 mod. <i>1P 16AX one way lightable switch mechanism to be completed with Domus and Class</i> <i>1 or 2 modules rocker - 1 module</i>		<b>3,80</b>	10 100
<b>441001ST</b>		□ <b>441001</b> ■ <b>449001</b> Interruttore 1P 16AX illuminabile - tasto intercambiabile - 1 modulo <i>1P 16AX one way lightable switch - interchangeable rocker - 1 module</i>		<b>3,70</b>	10 100
		□ <b>441001/10A</b> ■ <b>449001/10A</b> Interruttore 1P 10AX a tasto liscio - tasto intercambiabile - 1 modulo <i>1P 10AX one way smooth switch - interchangeable rocker - 1 module</i>		<b>3,53</b>	10 100
<b>441001</b> <b>441001/20A</b>	<b>449001</b> <b>449001/20A</b>	□ <b>441001/20A</b> ■ <b>449001/20A</b> Interruttore 1P 20AX illuminabile - tasto intercambiabile - 1 modulo <i>1P 20AX one way lightable switch - interchangeable rocker - 1 module</i>		<b>6,72</b>	10 100
		□ <b>441001/2</b> ■ <b>449001/2</b> Interruttore 1P 16AX a tasto largo illuminabile - tasto intercambiabile - 2 moduli <i>1P 16AX one way lightable large switch - interchangeable rocker - 2 modules</i>		<b>7,22</b>	5 50
<b>441001/2</b> <b>441001/20A</b>	<b>449001/2</b> <b>449001/20A</b>	□ <b>441001TL/2</b> Interruttore 1P 10AX a tasto largo liscio illuminabile - tasto intercambiabile - 2 moduli <i>1P 10AX one way lightable smooth large switch - interchangeable rocker - 2 modules</i>		<b>6,38</b>	5 50
		□ <b>441010</b> ■ <b>449010</b> Interruttore 2P 16AX illuminabile - tasto intercambiabile - 1 modulo <i>2P 16AX one way lightable switch - interchangeable rocker - 1 module</i>		<b>13,27</b>	10 100
<b>441010/2</b> <b>441010/20A</b>	<b>449010/2</b> <b>449010/20A</b>	□ <b>441010LV/20A</b> Interruttore bipolare a levetta 2P 20AX illuminabile - 1 modulo <i>2P 20AX lightable toggle one way switch - 1 module</i>		<b>28,22</b>	1 1
		□ <b>441010SL</b> ■ <b>449010SL</b> Interruttore 2P 16AX con gemma ad alta visibilità - tasto intercambiabile - 1 modulo <i>2P 16AX one way lightable switch with gem - interchangeable rocker - 1 module</i>		<b>15,47</b>	10 100
<b>441010SL</b> <b>441010/10A</b>	<b>449010SL</b> <b>449010/10A</b>	□ <b>441010/20A</b> ■ <b>449010/20A</b> Interruttore bipolare 2P 20AX illuminabile - tasto intercambiabile - 1 modulo <i>2P 20AX one way lightable switch - interchangeable rocker - 1 module</i>		<b>16,02</b>	1 1
		□ <b>441010/2</b> Interruttore 2P 16AX a tasto largo illuminabile - tasto intercambiabile - 2 moduli <i>2P 16AX one way lightable large switch - interchangeable rocker - 2 modules</i>		<b>16,67</b>	1 1
<b>441010LV/20A</b>		■ <b>442010RS/20A</b> Interruttore 2P 20AX illuminabile - rosso - 1 modulo <i>2P 20AX one way lightable switch - red - 1 module</i>		<b>16,15</b>	1 10
		<b>Nota:</b> forniti senza lampada di segnalazione <b>Note:</b> supplied without lamp			
<b>441010SL</b> <b>441010/20A</b>	<b>449010SL</b> <b>449010/20A</b>				
					
<b>441010</b> <b>441010/20A</b>	<b>449010</b> <b>449010/20A</b>				
					
<b>441010/2</b>					
					
<b>442010RS/20A</b>					

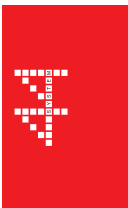



# Serie Domus - Class

Domus - Class series

Deviatori 250V~

Two way switches 250V~



78

Domus	Class	Descrizione Description	Info	€	□	□
		□ <b>441002ST</b> Corpo deviatore 1P 16AX illuminabile da completare con tasto Domus e Class 1 o 2 moduli - 1 modulo <i>1P 16AX two way lightable switch mechanism to be completed with Domus and Class 1 or 2 modules rocker - 1 module</i>		5,00	10	100
<b>441002ST</b>		□ <b>441002</b> ■ <b>449002</b> Deviatore 1P 16AX illuminabile - tasto intercambiabile - 1 modulo <i>1P 16AX two way lightable switch - interchangeable rocker - 1 module</i>		4,94	10	100
		□ <b>441002/10A</b> ■ <b>449002/10A</b> Deviatore 1P 10AX a tasto liscio illuminabile - tasto intercambiabile - 1 modulo <i>1P 10AX two way lightable smooth switch - interchangeable rocker - 1 module</i>		4,74	10	100
<b>441002</b> <b>441002/20A</b>	<b>449002</b>	□ <b>441002/20A</b> Deviatore 1P 20AX illuminabile - tasto intercambiabile - 1 modulo <i>1P 20AX two way lightable switch - interchangeable rocker - 1 module</i>		7,43	10	100
		□ <b>441002/2</b> ■ <b>449002/2</b> Deviatore 1P 16AX a tasto largo illuminabile - tasto intercambiabile - 2 moduli <i>1P 16AX two way lightable large switch - interchangeable rocker - 2 modules</i>		8,37	5	50
<b>441002/2</b>	<b>449002/2</b>	□ <b>441002LV</b> Deviatore a levetta 1P 10AX illuminabile - 1 modulo <i>1P 10AX toggle two-way switch - lightable - 1 module</i>		26,53	1	1
		□ <b>441002TL/2</b> ■ <b>449002TL/2</b> Deviatore 1P 10AX a tasto largo liscio illuminabile - tasto intercambiabile - 2 moduli <i>1P 10AX two way lightable smooth large switch - interchangeable rocker - 2 modules</i>		7,27	5	50
<b>441002/10A</b>	<b>449002/10A</b>	□ <b>441002K3/10A</b> ■ <b>449002K3/10A</b> Tripla deviatore 1P 10AX - n° 3 tasti indipendenti - 2 moduli <i>1P 10AX triple two way switch - 3 independent rockers - 2 modules</i>	△	15,23	5	5
						
<b>441002TL/2</b>	<b>449002TL/2</b>					
						
<b>441002LV</b>						
						
<b>441002K3/10A</b>	<b>449002K3/10A</b>					

Nota: forniti senza lampada di segnalazione

Note: supplied without lamp

### Morsetto "comune" "Common" terminal

Morsetto "comune" rialzato per un'immediata individuazione  
"Common" terminal raised for immediate identification

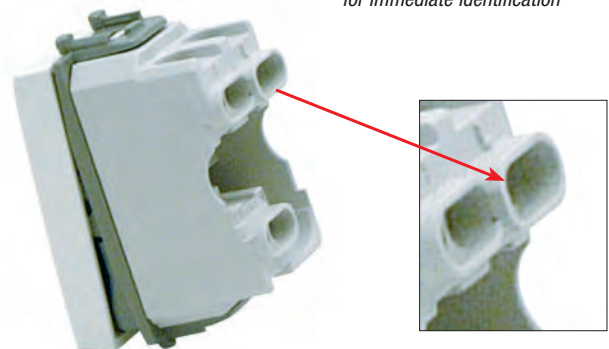

Per la disponibilità contattare la rete commerciale  
For availability please contact sales dept.



Disponibilità fino ad esaurimento scorte  
Available until stock out











Prodotto per scatola rettangolare inglese  
Product for British standard rectangular box











Prodotto per Export  
For Export only

## Invertitori 250V~ Intermediate switches 250V~

Domus	Class	Descrizione Description	Info	€	□	□
		<b>□ 441004ST</b> Corpo invertitore 1P 16AX illuminabile da completare con tasto Domus e Class 1 o 2 moduli - 1 modulo <i>1P 16AX lightable intermediate switch mechanism to be completed with Domus and Class 1 or 2 modules rocker - 1 module</i>		15,91	1	1
441004ST						
		<b>□ 441004</b> <b>■ 449004</b> Invertitore 1P 16AX illuminabile - tasto intercambiabile - 1 modulo <i>1P 16AX lightable intermediate switch - interchangeable rocker - 1 module</i>		16,19	10	100
441004	449004					
		<b>□ 441004/10A</b> <b>■ 449004/10A</b> Invertitore 1P 10AX a tasto liscio illuminabile - tasto intercambiabile - 1 modulo <i>1P 10AX intermediate lightable smooth switch - interchangeable rocker - 1 module</i>		15,61	1	1
441004/2						
		<b>□ 441004/2</b> Invertitore 1P 16AX a tasto largo illuminabile - tasto intercambiabile - 2 moduli <i>1P 16AX lightable large intermediate switch - interchangeable rocker - 2 modules</i>		18,72	5	50
441004/2						
		<b>□ 441004TL/2</b> <b>■ 449004TL/2</b> Invertitore 1P 16AX a tasto largo liscio illuminabile - tasto intercambiabile - 2 moduli <i>1P 16AX lightable smooth large intermediate switch - interchangeable rocker - 2 modules</i>		18,51	5	50
441004TL/2	449004TL/2					
		<b>□ 441004LV</b> Invertitore a levetta 1P 10AX illuminabile - 1 modulo <i>1P 10AX toggle two-way switch - lightable - 1 module</i>		29,85	1	1
441004LV						

Nota: forniti senza lampada di segnalazione  
 Note: supplied without lamp

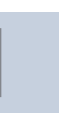
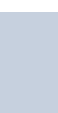
## Tasti intercambiabili per Interruttori, Deviatori e Invertitori Interchangeable rockers for one way switch, two way switch and intermediate switch

Domus	Class	Descrizione Description	Info	€	□	□
		<b>□ 441T</b> <b>■ 449T</b> Tasto intercambiabile liscio illuminabile - 1 modulo <i>Interchangeable smooth lightable rocker - 1 module</i>		1,30	14	14
441T	449T					
		<b>□ 441T/2</b> <b>■ 449T/2</b> Tasto intercambiabile liscio illuminabile - 2 moduli <i>Interchangeable smooth lightable rocker - 2 modules</i>		2,88	2	2
441T/2	449T/2					
		<b>□ 441TG</b> Tasto intercambiabile con gemma illuminabile - diffusore visibile anche di giorno - 1 modulo <i>Interchangeable rocker with lightable lens - diffuser visible even in daylight - 1 module</i>		2,53	14	14
441TG						
		<b>□ 441TG/2</b> Tasto intercambiabile con gemma illuminabile - diffusore visibile anche di giorno - 2 moduli <i>Interchangeable rocker with lightable lens - diffuser visible even in daylight - 2 modules</i>		4,13	2	2
441TG/2						
		<b>□ 441TG/3</b> Tasto intercambiabile con gemma illuminabile - diffusore visibile anche di giorno - 3 moduli <i>Interchangeable rocker with lightable lens - diffuser visible even in daylight - 3 modules</i>		6,52	3	30
441TG/3						
		<b>□ 441TSL</b> <b>■ 449TSL</b> Tasto intercambiabile con gemma ad alta visibilità - da utilizzare con corpo comando 44500..ST - 1 modulo <i>Interchangeable button with high visibility gem - to be used with 44500..ST - 1 module</i>		2,63	5	5
441TSL	449TSL					

Le dimensioni, salvo diversamente specificato, sono in mm  
 Dimensions, except where otherwise specified, are in mm

 Imballo Minimo pcs  
 Min. Packaging pcs

 Imballo Standard pcs  
 Std. Packaging pcs



















# Serie Domus - Class

Domus - Class series

Pulsanti 250V~  
Push-buttons 250V~



80

Domus	Class	Descrizione Description	Info	€	□	□
		<input type="checkbox"/> <b>441005ST</b> Corpo pulsante 1P NA 10A illuminabile da completare con tasto Domus e Class 1 o 2 moduli - 1 modulo <i>1P NO 10A lightable push-button mechanism to be completed with Domus and Class 1 or 2 mod rocker - 1 module</i>		4,84	10	100
441005ST		<input checked="" type="checkbox"/> <b>442005ST</b> Corpo pulsante 1P NA 10A illuminabile da completare con tasto Tekla 1 o 2 moduli - 1 modulo <i>1P NO 10A lightable push-button mechanism to be completed with Tekla 1 or 2 mod rocker - 1 module</i>		8,98	10	100
		<input type="checkbox"/> <b>441005</b> <input checked="" type="checkbox"/> <b>449005</b> Pulsante 1P NA 10A illuminabile - tasto intercambiabile - 1 modulo <i>1P NO 10A lightable push-button - interchangeable rocker - 1 module</i>		5,00	10	100
441005 441005/10A 441005/2P 441025	449005 449025 449005/10A	<input type="checkbox"/> <b>441005/10A</b> <input checked="" type="checkbox"/> <b>449005/10A</b> Pulsante 1P NA 10A a tasto liscio illuminabile - tasto intercambiabile - 1 modulo <i>1P NO 10A lightable smooth push-button - interchangeable rocker - 1 module</i>		4,74	10	100
		<input type="checkbox"/> <b>441005/2</b> <input checked="" type="checkbox"/> <b>449005/2</b> Pulsante 1P NA 10A a tasto largo illuminabile - tasto intercambiabile - 2 moduli <i>1P NO 10A large lightable push-button - interchangeable rocker - 2 modules</i>		7,91	5	50
		<input type="checkbox"/> <b>441005TL/2</b> Pulsante 1P NA 10A a tasto largo liscio illuminabile - tasto intercambiabile - 2 moduli <i>1P NO 10A smooth large lightable push-button - interchangeable rocker - 2 modules</i>		7,63	5	50
441005/2	449005/2	<input type="checkbox"/> <b>441005/2P</b> Pulsante 2P NA 10A illuminabile - tasto intercambiabile - 1 modulo <i>2P NO 10A lightable push-button - interchangeable rocker - 1 module</i>		10,14	1	10
		<input type="checkbox"/> <b>441005LV</b> Pulsante a levetta 1P NA 10A illuminabile - 1 modulo <i>1P NO 10A toggle push-button - lightable - 1 module</i>		26,02	1	1
441005TL/2		<input type="checkbox"/> <b>441005SL</b> <input checked="" type="checkbox"/> <b>449005SL</b> Pulsante 1P NA 10A con gemma ad alta visibilità - 1 modulo <i>1P NO 10A high visibility push-button with gem - 1 module</i>		7,74	10	100
		<input type="checkbox"/> <b>441025</b> <input checked="" type="checkbox"/> <b>449025</b> Pulsante 1P NA+NC 10A illuminabile - tasto intercambiabile - 1 modulo <i>1P NO+NC 10A lightable push-button - interchangeable rocker - 1 module</i>		8,86	10	10
		<input type="checkbox"/> <b>441050</b> <input checked="" type="checkbox"/> <b>449050</b> Pulsante 1P NA 10A 250V con spia di segnalazione illuminabile - diffusore trasparente - fornito con etichette di personalizzazione - 1 modulo <i>1P NO 10A 250V - lightable push-button -transparent diffuser - supplied with customization labels - 1 module</i>		15,67	1	10
441005LV		<input type="checkbox"/> <b>441056</b> <input checked="" type="checkbox"/> <b>449056</b> Doppio pulsante 1P NA + 1P NA 10A - illuminabile (solo versione Domus - Class) - senza interblocco: è consentita la chiusura contemporanea dei 2 circuiti - 1 modulo <i>1P NO + 1P NO 10A double push-button - lightable - without interblock: the simultaneous closure of the 2 circuits is allowed - 1 module</i>		15,32	1	10
						
441005SL	449005SL					
						
441050	449050					
						
441056	449056					

**Note:** ✓ gli articoli illuminabili sono forniti senza lampada di segnalazione  
✓ 44..056 consentendo la chiusura contemporanea di due circuiti non sono adatti all'inversione di marcia di motori (es. tapparelle, ecc.)

**Notes:** ✓ lightable articles are supplied without lamp  
✓ Since 44..056 allow the simultaneous closure of two circuits, they are not suitable for motor reversing (ex. rolling shutter, ecc.)



Per la disponibilità contattare la rete commerciale  
For availability please contact sales dept.



Disponibilità fino ad esaurimento scorte  
Available until stock out









Prodotto per scatola rettangolare inglese  
Product for British standard rectangular box



Prodotto per Export  
For Export only

Pulsanti 250V~  
Push-buttons 250V~

Domus	Class	Descrizione Description	Info	€	□	□
 441056F	 449056F	<p>□ 441056F      ■ 449056F</p> <p>Doppio pulsante 1P NA + 1P NA 10A con frecce direzionali - illuminabile (solo versione Domus - Class) - senza interblocco: è consentita la chiusura contemporanea dei 2 circuiti - 1 modulo <i>1P NO + 1P NO 10A double push-button with arrows - lightable - without interblock : the simultaneous closure of the 2 circuits is allowed - 1 module</i></p>		15,32	1	10
 441017	 449017	<p>□ 441017      ■ 449017</p> <p>Pulsante 1P NA+NC 10A a tirante - cordone in materiale isolante 1,5 m - 1 modulo <i>1P NO+NC 10A cord operated push-button - insulating material cord 1,5 m - 1 module</i></p>		15,49	1	10
 441005TP/2	 442025RS/2	<p>□ 441005TP/2</p> <p>Pulsante 1P NA 10A con targhetta portanome retroilluminabile - illuminazione a mezzo lampada con attacco E10 10x28 mm tipo T10 1,5W max ad incandescenza o led - fornito senza lampada - fornito con cartoncino portanome personalizzabile - 2 moduli <i>1P NO 10A push-button with lightable name tag - illumination by incandescent or led lamp E10 10x28 mm T10 1,5W max type - supplied with customizable name tag card - supplied without lamp - 2 modules</i></p> <p>■ 442025RS/2</p> <p>Pulsante di emergenza 1P NA+NC 10A a tasto largo illuminabile - rosso - 2 moduli <i>1P NO+NC 10A large emergency push-button - red - 2 modules</i></p>		21,40	1	6

- Note:**
- ✓ gli articoli illuminabili sono forniti senza lampada di segnalazione
  - ✓ 44..056F consentendo la chiusura contemporanea di due circuiti non sono adatti all'inversione di marcia di motori (es. tapparelle, ecc.)
- Notes:**
- ✓ lightable articles are supplied without lamp
  - ✓ Since 44..056F allow the simultaneous closure of two circuits, they are not suitable for motor reversing (ex. rolling shutter, ecc.)

Sistema 45

Pulsante con targhetta portanome Push button with name tag

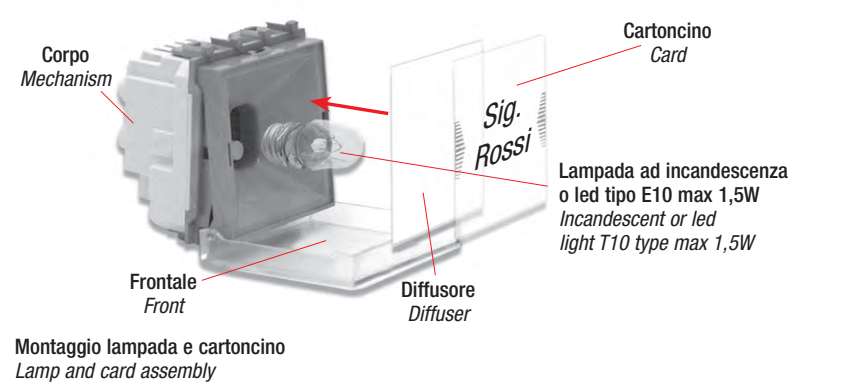

























# Serie Domus - Class

Domus - Class series

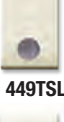

Tasti intercambiabili per pulsanti  
Interchangeable rockers for push buttons

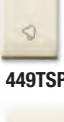
82

Domus	Class	Descrizione Description	Info	€	□	□
 441T	 449T	<input type="checkbox"/> 441T <input checked="" type="checkbox"/> 449T Tasto intercambiabile liscio illuminabile - 1 modulo Interchangeable smooth lighttable rocker - 1 module		1,30	14	14
 441T/2	 449T/2	<input type="checkbox"/> 441T/2 <input checked="" type="checkbox"/> 449T/2 Tasto intercambiabile liscio illuminabile - 2 moduli Interchangeable smooth lighttable rocker - 2 modules		2,88	2	2
 441TGP	 449TGP	<input type="checkbox"/> 441TGP <input checked="" type="checkbox"/> 449TGP Tasto intercambiabile con gemma illuminabile - diffusore visibile anche di giorno - 1 modulo Interchangeable rocker with lighttable lens - diffuser visible even in daylight - 1 module		2,47	14	14
 441TGP/2	 449TGP/2	<input type="checkbox"/> 441TGP/2 <input checked="" type="checkbox"/> 449TGP/2 Tasto intercambiabile con gemma illuminabile - diffusore visibile anche di giorno - 2 moduli Interchangeable rocker with lighttable lens - diffuser visible even in daylight - 2 modules		4,16	2	2
 441TKP	 449TKP	<input type="checkbox"/> 441TKP <input checked="" type="checkbox"/> 449TKP Tasto intercambiabile con simbolo CHIAVE illuminabile - 1 modulo Interchangeable rocker with lighttable KEY symbol - 1 module		2,36	14	14
 441TKP/2	 449TKP/2	<input type="checkbox"/> 441TKP/2 <input checked="" type="checkbox"/> 449TKP/2 Tasto intercambiabile con simbolo CHIAVE illuminabile - 2 moduli Interchangeable rocker with lighttable KEY symbol - 2 modules		3,60	2	2
 441TLP	 449TLP	<input type="checkbox"/> 441TLP <input checked="" type="checkbox"/> 449TLP Tasto intercambiabile con simbolo LAMPADA illuminabile - 1 modulo Interchangeable rocker with lighttable LAMP symbol - 1 module		2,36	14	14
 441TLP/2	 449TLP/2	<input type="checkbox"/> 441TLP/2 <input checked="" type="checkbox"/> 449TLP/2 Tasto intercambiabile con simbolo LAMPADA illuminabile - 2 moduli Interchangeable rocker with lighttable LAMP symbol - 2 modules		3,60	2	2
 441TKP	 449TKP	<input type="checkbox"/> 441TKP <input checked="" type="checkbox"/> 449TKP Tasto intercambiabile con gemma ad alta visibilità - da utilizzare con corpo comando 44500..ST - 1 modulo Interchangeable button with high visibility gem - to be used with 44500..ST - 1 module		2,63	5	5
 441TSP	 449TSP	<input type="checkbox"/> 441TSP <input checked="" type="checkbox"/> 449TSP Tasto intercambiabile con simbolo SUONERIA illuminabile - 1 modulo Interchangeable rocker with lighttable BELL symbol - 1 module		2,36	14	14
 441TSP/2	 449TSP/2	<input type="checkbox"/> 441TSP/2 <input checked="" type="checkbox"/> 449TSP/2 Tasto intercambiabile con simbolo SUONERIA illuminabile - 2 moduli Interchangeable rocker with lighttable BELL symbol - 2 modules		3,60	2	2

### Comandi con tasti intercambiabili Controls with interchangeable rockers

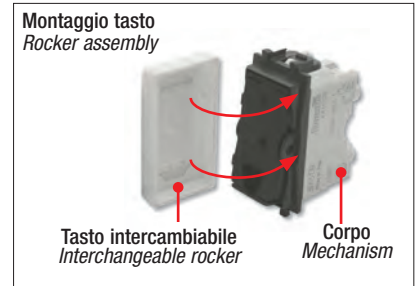

### Illuminazione simboli Domus Domus illumination for symbols

Rimuovere la paretina abbattibile solo per tasti con simbologie  
Pull the removable cover only for rockers with symbols

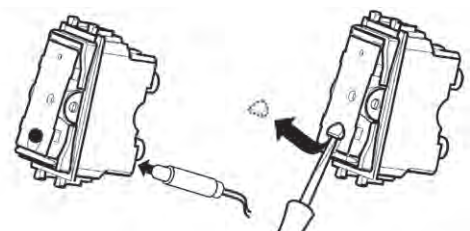

Per la disponibilità contattare la rete commerciale  
For availability please contact sales dept.



Disponibilità fino ad esaurimento scorte  
Available until stock out























Prodotto per scatola rettangolare inglese  
Product for British standard rectangular box



Prodotto per Export  
For Export only

## Tasti intercambiabili per pulsanti















### Interchangeable rockers for push buttons

Domus	Class	Descrizione Description	Info	€	□	□	
				<input type="checkbox"/> <b>441TLSP</b> <input checked="" type="checkbox"/> <b>449TLSP</b> Tasto intercambiabile con simbolo LUCE SCALE illuminabile - 1 modulo <i>Interchangeable rocker with lightable STAIR LIGHT symbol - 1 module</i>	2,36	14	14
				<input type="checkbox"/> <b>441TBP</b> <input checked="" type="checkbox"/> <b>449TBP</b> Tasto intercambiabile con simbolo BOILER illuminabile - 1 modulo <i>Interchangeable rocker with lightable BOILER symbol - 1 module</i>	2,42	14	14
				<input type="checkbox"/> <b>441TREP</b> <input checked="" type="checkbox"/> <b>449TREP</b> Tasto intercambiabile illuminabile con simbolo RESISTENZA ELETTRICA - 1 modulo <i>Interchangeable rocker with lightable ELECTRICAL RESISTANCE symbol - 1 module</i>	2,36	14	14
				<input type="checkbox"/> <b>441TNDP</b> <input checked="" type="checkbox"/> <b>449TNDP</b> Tasto intercambiabile illuminabile con simbolo/scritta DO NOT DISTURB - 1 modulo <i>Interchangeable rocker with lightable DO NOT DISTURB symbol - 1 module</i>	2,36	14	14
				<input type="checkbox"/> <b>441TG/3</b> <input checked="" type="checkbox"/> <b>449TPCP</b> Tasto intercambiabile illuminabile con simbolo/scritta PLEASE CLEAN - 1 modulo <i>Interchangeable rocker with lightable PLEASE CLEAN symbol - 1 module</i>	2,36	14	14
				<input type="checkbox"/> <b>441TG/3</b> Tasto intercambiabile con gemma illuminabile - diffusore visibile anche di giorno - 3 moduli <i>Interchangeable rocker with lightable lens - diffuser visible even in daylight - 3 modules</i>	6,52	3	30

83

Sistema 45

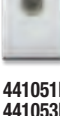
## Commutatori 250V~ Rolling blind switches 250V~

Domus	Class	Descrizione Description	Info	€	□	□
		<input type="checkbox"/> <b>441051</b> <input checked="" type="checkbox"/> <b>449051</b> Commutatore 1P 10AX (3 morsetti) - 3 posizioni (OFF centrale) - con interblocco: non è consentita la chiusura contemporanea dei 2 circuiti - 2 tasti - con frecce direzionali - 1 modulo <i>1P 10AX rolling blind switch (3 terminals) - 3 positions (central OFF) - with interlock: the simultaneous closure of the 2 circuits is not allowed - 2 rockers - with arrows - 1 module</i>	18,37	1	10	
		<input type="checkbox"/> <b>441052</b> <input checked="" type="checkbox"/> <b>449052</b> Commutatore 2P 10AX (6 morsetti) - 3 posizioni (OFF centrale) - con interblocco: non è consentita la chiusura contemporanea dei 2 circuiti - 2 tasti - con frecce direzionali - 1 modulo <i>2P 10AX rolling blind switch (6 terminals) - 3 positions (central OFF) - with interlock: the simultaneous closure of the 2 circuits is not allowed - 2 rockers - with arrows - 1 module</i>	22,38	1	10	
		<input type="checkbox"/> <b>441053</b> <input checked="" type="checkbox"/> <b>449053</b> Commutatore 1P 10A (3 morsetti) a pulsante - 3 posizioni (OFF centrale) - con interblocco: non è consentita la chiusura contemporanea dei 2 circuiti - 2 tasti - con frecce direzionali - 1 modulo <i>1P 10A rolling blind push-button (3 terminals) - 3 positions (central OFF) - with interlock: the simultaneous closure of the 2 circuits is not allowed - 2 rockers - with arrows - 1 module</i>	19,15	1	10	
		<input type="checkbox"/> <b>441054</b> <input checked="" type="checkbox"/> <b>449054</b> Commutatore 2P 10A (6 morsetti) a pulsante - 3 posizioni (OFF centrale) - con interblocco: non è consentita la chiusura contemporanea dei 2 circuiti - 2 tasti - con frecce direzionali - 1 modulo <i>2P 10A rolling blind push-button (6 terminals) - 3 positions (central OFF) - with interlock: the simultaneous closure of the 2 circuits is not allowed - 2 rockers - with arrows - 1 module</i>	19,66	1	10	
		<input type="checkbox"/> <b>441051BS</b> <input checked="" type="checkbox"/> <b>449051BS</b> Commutatore a bascula 1P 10AX 3 posizioni (OFF centrale) con frecce direzionali - 1 modulo <i>1P 10AX rolling blind switch 3 positions (central OFF) with arrows - 1 module</i>	16,66	1	10	
		<input type="checkbox"/> <b>441053BS</b> <input checked="" type="checkbox"/> <b>449053BS</b> Commutatore pulsante a bascula 1P 10A 3 posizioni con frecce direzionali - 1 modulo <i>1P 10A rolling blind push-button 3 positions (central OFF) with arrows - 1 module</i>	16,41	1	10	
		<input type="checkbox"/> <b>441051LV</b> Commutatore a levetta 1P 10AX (3 morsetti) - 3 posizioni (OFF centrale) - con interblocco - con frecce direzionali - 1 modulo <i>1P 10AX toggle rolling blind (3 terminals) - 3 positions (central OFF) - with interlock - with arrows - 1 module</i>	28,32	1	10	
		<input type="checkbox"/> <b>441053LV</b> Commutatore pulsante senza freccia a levetta 1P 10A (3 morsetti) - 3 posizioni (OFF centrale) - con interblocco - 1 modulo <i>1P 10A toggle push button rolling blind (3 terminals) - 3 positions (central OFF) without arrow - with interlock - 1 module</i>	28,58	1	1	

Nota: 44...052 e 44...54 utilizzabili per inversione di marcia, es. motori abbaini. Comandi non illuminabili.  
 Note: 44...52 and 440054 usable for reversing, e.g. dormer motors. Not lightable controls.

Le dimensioni, salvo diversamente specificato, sono in mm  
 Dimensions, except where otherwise specified, are in mm

Imballo Minimo pcs  
 Min. Packaging pcs

Imballo Standard pcs  
 Std. Packaging pcs

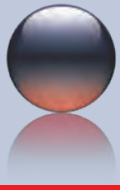

### Applicazioni con 44..016S Applications with 44..016S

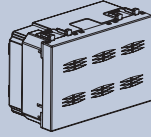

441016S  
445016S  
449016S

Dispositivo Multi Touch "a sfioramento"  
Multi touch control device

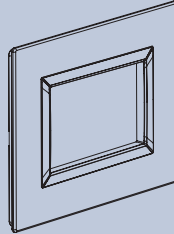

44PV3...  
Placca "Vera 44" per scatola rettangolare  
"Vera 44" front plate for rectangular box

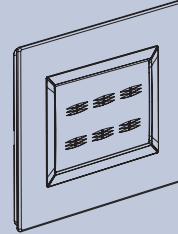

44..016S + 44PV3...

### Personalizzazione comando 44..016S Customization touch control device 44..016S

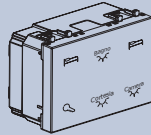

441016S  
445016S  
449016S

Dispositivo Multi Touch "a sfioramento" personalizzato  
Customized multi touch control device

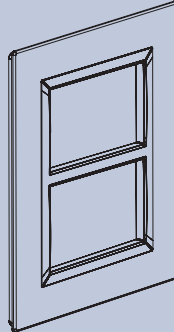

44PV33...  
Placca "Vera 44" per scatola BL02P  
"Vera 44" front plate for BL02P box

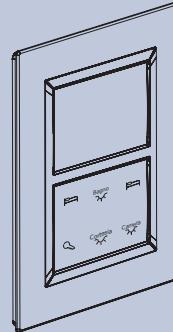

44..016S + 44PV33...

Per verificarne la fattibilità e i costi contattare la rete commerciale Ave Please check costs and feasibility with Ave export sales department.

### Applicazioni con 442TC05 Applications with 442TC05

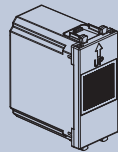

442TC05  
Pulsante "a scomparsa"  
Touch push-button "hidden installation"

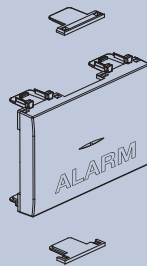

441013A/3  
445013A/3  
449013A/3  
Tappo copriforo attrezzabile  
Equippable blank insert

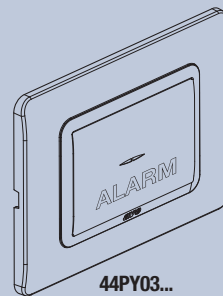

44PY03...  
Placche 3 moduli S44  
S44 3 modules front plates

### Esempi di personalizzazione Customization examples













Per la disponibilità contattare la rete commerciale  
For availability please contact sales dept.

Disponibilità fino ad esaurimento scorte  
Available until stock out

# Prodotto per scatola rettangolare inglese  
Product for British standard rectangular box

△ Prodotto per Export  
For Export only

Comandi 230V~ "a sfioramento"  
"Touch" controls 230V~

Domus	Class	Descrizione Description	Info	€	□	□
 441001S	 449001S	<p><b>□ 441001S</b>      <b>■ 449001S</b></p> <p>Interruttore elettronico con uscita a relè 1P NA 6A 230V~ - comando mediante sfioro superficie frontale o da più punti con normali pulsanti NA - funzionamento bistabile - led di individuazione al buio a basso consumo - memorizzazione dello stato del relè d'uscita in caso di interruzione di rete - alimentazione 230V~ - 1 modulo</p> <p><i>Electronic touch switch - relay output 1P NO 6A 230V~ - controlled by touching the frontal area or from multiple points with NO push buttons - bistable operating mode - low consumption led for identification in the dark - output relay status memorization in case of black out - 230V~ power supply - 1 module</i></p>		70,98	1	10
 441005S	 449005S	<p><b>□ 441005S</b>      <b>■ 449005S</b></p> <p>Pulsante elettronico per comando remoto con sensore a sfioramento - comando mediante sfioro superficie frontale - funzionamento monostabile - led di individuazione al buio a basso consumo - alimentazione 230V~ - da abbinare a interruttore elettronico 441001S, dimmer a sfioramento 441048SU o commutatore a sfioramento 441051S - 1 modulo</p> <p><i>Electronic push button for remote control with touch sensor - controlled by touching the frontal area - monostable operating mode - low consumption led for identification in the dark - 230V~ power supply - to be combined with electronic switch 441001S, with touch dimmer 441048SU or touch rolling blind switch 441051S - 1 module</i></p>		67,68	1	10
 441016S	 449016S	<p><b>□ 441016S</b>      <b>■ 449016S</b></p> <p>Comando elettronico multi-touch con 6 uscite a relè monostabili con contatto in chiusura 1P NA 2A 230V~ libero da potenziale - comando mediante sfioro superficie frontale o da più punti con normali pulsanti NA - funzionamento uscite: monostabili, bistabili o temporizzate, tapparelle (con interblocco funzionale) - n° 6 led frontali (di cui solo massimo 6 contemporaneamente accesi) di individuazione al buio a basso consumo - memorizzazione dello stato dei relè d'uscita in caso di interruzione di rete - alimentazione 100÷240V~ 50-60 Hz - 3 moduli</p> <p><i>Electronic multi-touch control - 6 monostable output-relay 1P NO 2A 230V~ Dry contact - controlled by touching the frontal area or from multiple points with NO push-buttons - operating mode: monostable, bistable or timed, curtains (with interlock) - n. 6 low consumption front leds for identification in the darkness (max 6 leds active at the same time) - status memory in case of blackout - powered 100÷240 V ~ 50-60 HZ - 3 modules.</i></p>		237,98	1	1
 441051S		<p><b>□ 441051S</b></p> <p>Commutatore elettronico con uscita a 2 relè monostabili con contatto in chiusura NA 2A 230V~ - comando mediante sfioro superficie frontale o da più punti con normali pulsanti NA - funzionamento monostabile o temporizzato - led di individuazione al buio a basso consumo - alimentazione 230V~ - 1 modulo</p> <p><i>Electronic touch rolling blind switch with 2 monostable relay output, NO contact 2A 230V~ - controlled by touching the frontal area or from multiple points with NO push buttons - monostable or timed operating mode - low consumption LED for identification in the dark - 230V~ power supply - 1 module</i></p>		82,05	1	10
 441048SU		<p><b>□ 441048SU</b></p> <p>Regolatore di luminosità 230V~ per carichi resistivi e induttivi (lampade ad incandescenza e alogene 40-400W, trasformatori ferromagnetici per lampade alogene in bassissima tensione 40-400VA, trasformatori elettronici con comportamento induttivo  40-300VA tipo OSRAM HALOTRONIC HTM 70/230-240, HTM 105/230-240, HTM 150/230-240) - comando e regolazione mediante sfioro superficie frontale o da più punti con normali pulsanti NA - led di individuazione al buio a basso consumo - memorizzazione dello stato e del livello dell'uscita in caso d'interruzione di rete - 1 modulo 230V~ dimmer for resistive and inductive loads (incandescent and halogen lamps 40-400W, ferromagnetic transformers for low voltage 40-400 VA halogen lamps, electronic inductive transformer type  40-300VA OSRAM HALOTRONIC HTM 70/230-240, HTM 105/230-240, HTM 150/230-240) - controlled by touching the frontal area or from multiple points with NO buttons - low consumption led for identification in the darkness - status and level memory in case of black out - 1 module</p>		84,45	1	10

Sistema 45



# Serie Domus - Class

Domus - Class series

Dimmer per regolazione luci

Dimmer for lighting controls



86

Domus	Class	Descrizione Description	Info	€	□	□
-------	-------	-------------------------	------	---	---	---



441018

### □ 441018

Regolatore di luminosità 230V~ (127 V~) 50-60Hz per carichi resistivi (lampade ad incandescenza e alogene) 60÷800W (30÷500W) e induttivi (trasformatori ferromagnetici ed elettronici) 40÷300VA - regolazione con potenziometro rotativo - led di individuazione al buio - non dotato di filtro EMC - 1 modulo

*Dimmer 230V~ (127 V~) 50-60Hz for resistive loads (incandescent and halogen lamps) 60÷800W (30÷500W) and inductive (ferromagnetic and electronic transformers) 40÷300VA - regulation with rotary potentiometer - led for identification in the dark - EMC filter not included - 1 module*

△ 40,45 1 6



441048

### □ 441048

Regolatore di luminosità 230V~ (127 V~) 50-60Hz - TRIAC - taglio di fase per lampade ad incandescenza e alogene 100÷500W - regolazione con potenziometro rotativo - led di individuazione al buio - 1 modulo

*Dimmer 230V~ (127 V~) 50-60Hz for resistive loads (incandescent and halogen lamps) 100÷500W (60÷300W) - regulation with rotary potentiometer - led for identification in the dark - 1 module*

41,47 1 6



441048D



449048D

### □ 441048D

### ■ 449048D

Regolatore di luminosità 230V~ 50-60Hz - TRIAC - taglio di fase per lampade ad incandescenza e alogene 40÷300W - comando con deviatore incorporato e regolazione con potenziometro rotativo - led di individuazione al buio - profondità ridotta - viti dei morsetti laterali - 1 modulo

*Dimmer 230V~ 50-60Hz for resistive loads (incandescent and halogen lamps) 40÷300W - control with built-in two-way switch and regulation with rotary potentiometer - led for identification in the dark - reduced depth - side terminal screws - 1 module*

50,22 1 6



441048UL



449048UL

### □ 441048UL

### ■ 449048UL

Regolatore di luminosità 230V~ 50-60 Hz per carichi resistivi e induttivi (lampade ad incandescenza e alogene 3-220W, trasformatori elettronici 20-220W, lampade LED 3-120W, lampade CFL 3-220W - alimentatori elettronici LED a taglio di fase) - comando e regolazione con pulsante incorporato o da più punti con normali pulsanti NA - led di individuazione al buio a basso consumo - memorizzazione dello stato e del livello dell'uscita in caso d'interruzione di rete - 1 modulo

*230V~ 50-60 Hz dimmer for resistive and inductive loads (3-220W incandescent and halogen lamps, ferromagnetic transformers 20-220W, LED lamps 3-120W, CFL lamps 3-220W - electronic ballasts for LED with line interruption) - control and regulation by built-in push-button or by normal NO push-button from more points - low consumption led for identification in the dark - status and level memory in case of blackout - 1 module*

91,64 1 6



441048UR



449048UR

### □ 441048UR

### ■ 449048UR

Regolatore di luminosità 230V~ 50Hz per lampade ad incandescenza, alogene e LED 3-120W - regolazione con potenziometro rotativo - non dotato di filtro EMC - 1 modulo

*Dimmer 230V~ 50Hz for incandescent, halogen and LED lamps 3-120W - adjustment with rotary potentiometer - not equipped with EMC filter - 1 module*



47,50 1 6



441048L

### □ 441048L

Regolatore di luminosità 230V~ 50-60Hz per trasformatori elettronici con comportamento capacitivo 40-250VA - comando e regolazione con pulsante incorporato o da più punti con normali pulsanti NA - led di individuazione al buio - 1 modulo

*Dimmer 230V~ 50-60Hz for electronic transformers with 40-250VA capacitive functioning - control and regulation by built-in push-button or by normal NO push-button from more points - led for identification in the dark - 1 module*

68,42 1 6



441048AE

### □ 441048AE

Regolatore per alimentatori elettronici ingresso 1÷10V - contatto 4A/250V~ - 1 modulo

*Dimmer for electronic power units input 1÷10V - contact 4A/250V~ - 1 module*

84,41 1 6

**Nota:** 441018 utilizzabile solo in paesi non membri dell'Unione Europea

**Note:** 441018 must be used only in non-EU Countries



Per la disponibilità contattare la rete commerciale  
For availability please contact sales dept.



Disponibilità fino ad esaurimento scorte  
Available until stock out











Prodotto per scatola rettangolare inglese  
Product for British standard rectangular box



Prodotto per Export  
For Export only



## Comandi a chiave key commands

Domus	Class	Descrizione Description	Info	€	□	□
 441071 441071MC 441071EA 441071MCEA	 449071	<input type="checkbox"/> <b>441071</b> <input checked="" type="checkbox"/> <b>449071</b> Interruttore 2P 10AX con chiave - codifica chiave casuale - fornito con 2 chiavi - la chiave esce in entrambe le posizioni - 1 modulo <i>2P 10AX one way switch with key - random key coding - supplied with 2 keys            - the key exits in both positions - 1 module</i>		49,82	1	10
		<input type="checkbox"/> <b>441071MC</b> Interruttore 2P 10AX con chiave unificata - codifica chiave "511" - fornito con 2 chiavi - la chiave esce in entrambe le posizioni - 1 modulo <i>2P 10AX one way switch with unified key - key code "511" - supplied with 2 keys            - the key exits in both positions - 1 module</i>		49,82	1	10
 441071EA 441071MCEA	 449075	<input type="checkbox"/> <b>441071EA</b> Interruttore 2P 10AX con chiave estraibile solo in posizione di aperto- codifica chiave casuale - fornito con 2 chiavi - 1 modulo <i>2P 10AX one way switch with key - random key coding - supplied with 2 keys            - the key exits in 0 position - 1 module</i>		49,82	1	1
		<input type="checkbox"/> <b>441071MCEA</b> Interruttore 2P 10AX con chiave estraibile solo in posizione di aperto - codifica chiave "511" - fornito con 2 chiavi - 1 modulo <i>2P 10AX one way switch with key - key code "511" - supplied with 2 keys            - the key exits in 0 position - 1 module</i>		49,82	1	1
 441072 441072MC	 449075	<input type="checkbox"/> <b>441072</b> Deviatore 1P 10AX con chiave - codifica chiave casuale - fornito con 2 chiavi - la chiave esce in entrambe le posizioni - 1 modulo <i>1P 10AX two way switch with key - random key encoding - supplied with 2 keys            - the key exits in both positions - 1 module</i>		50,64	1	10
		<input type="checkbox"/> <b>441072MC</b> Deviatore 1P 10AX con chiave unificata - codifica chiave "511" - fornito con 2 chiavi - la chiave esce in entrambe le posizioni - 1 modulo <i>1P 10AX two way switch with unified key - key code "511" - supplied with 2 keys - the key exits in both positions - 1 module</i>		50,64	1	10
 441075 441075MC	 449075	<input type="checkbox"/> <b>441075</b> <input checked="" type="checkbox"/> <b>449075</b> Pulsante 2P NA 10A con chiave - codifica chiave casuale - fornito con 2 chiavi - la chiave esce solo in posizione di aperto - 1 modulo <i>2P NO 10A push-button with key - random key coding - supplied with 2 keys            - the key exits only in the open position - 1 module</i>		50,26	1	10
		<input type="checkbox"/> <b>441075MC</b> Pulsante 2P NA 10A con chiave unificata - codifica chiave "511" - fornito con 2 chiavi - la chiave esce solo in posizione di aperto - 1 modulo <i>2P NO 10A push-button with unified key - key code "511" - supplied with 2 keys            - the key exits only in the open position - 1 module</i>		50,26	1	10

**Note:** ✓ a richiesta i deviatori a chiave 44..072 e 441072MC potranno essere forniti con chiave estraibile solo in posizione "0"

**Note:** ✓ 44..072 and 441072MC two way switches with key can be supplied with key removable only in the "0" position upon request



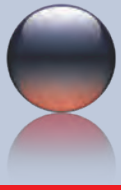

# Serie Domus - Class

Domus - Class series

Rilevatori di presenza

Detectors



### Diagramma di copertura *Covering Diagram*

Vista in pianta *Plan view*

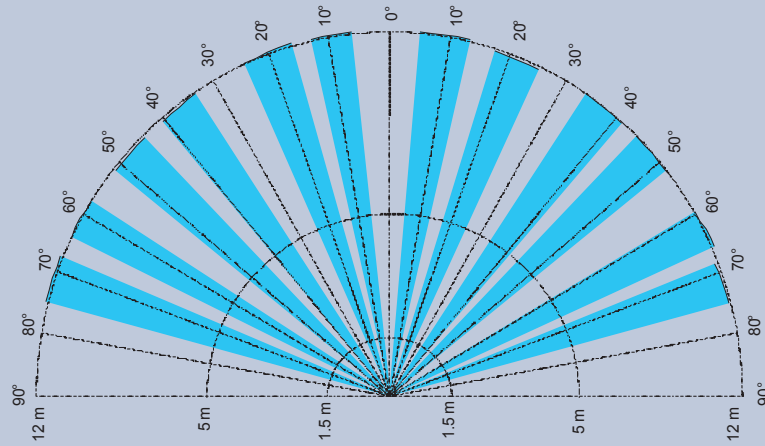

Vista laterale *Side view*

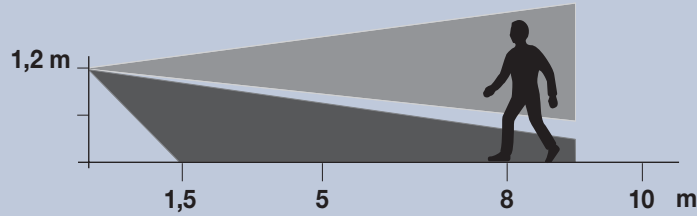

### Schemi applicativi *Application Diagrams*

Installazione per comando carico da due o più punti di rivelazione  
*Installation to control the load from two or more detecting spots*

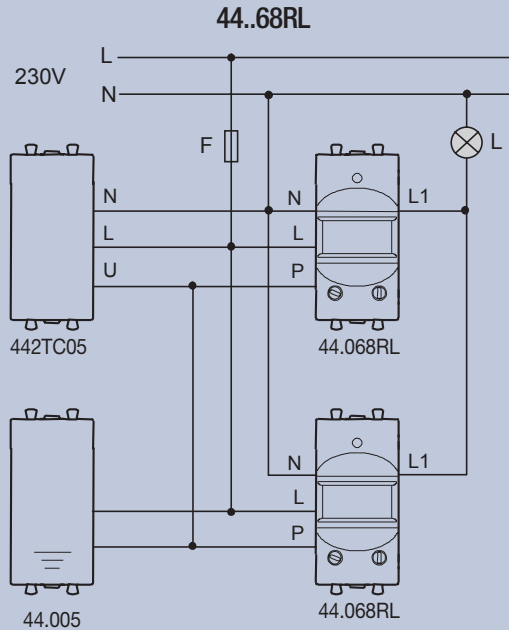

L: carico NA 10A 230V    L: load NA 10A 230V    F: fusibile tipo T 10 H 250 V    F: fuse type T 10 H 250 V



Per la disponibilità contattare la rete commerciale  
 For availability please contact sales dept.



Disponibilità fino ad esaurimento scorte  
 Available until stock out



Prodotto per scatola rettangolare inglese  
 Product for British standard rectangular box



Prodotto per Export  
 For Export only

## Rilevatori di presenza Detectors





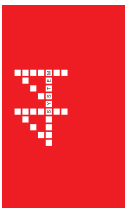



Domus	Class	Descrizione Description	Info	€	□	□
		<p>□ 441068RL      ■ 449068RL</p> <p>LUCE AMICA Rivelatore di movimento a raggi infrarossi per accensione luci - uscita a relè NA 10(4)A 230V~ - alimentazione 110÷230V~ - regolazione frontale del ciclo di temporizzazione da 10 s a 7 min - regolazione frontale della soglia della luminosità ambiente - lente fissa con portata regolabile da 2 m a 12 m e apertura 150° - ingresso per pulsanti di comando remoti - possibilità di impostazione funzionamento: Automatico/Crepuscolare/Forzatura ON/Semiautomatico - 1 modulo</p> <p>LUCE AMICA Infrared motion detector for lighting control - NO 10(4)A 230V~ output relay - 110÷230V~ power supply - Frontal duty cycle time regulation from 10 s to 7 min - Frontal regulation of light sensitivity threshold - fixed lens range from 2 m to 12 m and 150° opening - input for remote controls push buttons - possibility to set operating mode: Automatic/Night/Forced ON/Semi-Automatic - 1 module</p>	134,72	1	6	

89



Sistema 45

## Copriforo e uscita Blank insert and cable outlet

Domus	Class	Descrizione Description	Info	€	□	□
		<p>□ 441008</p> <p>Uscita Ø 9 mm con serracavo antitrazione - consente il passaggio di cavi da Ø 4 mm a Ø 8 mm - 1 modulo</p> <p>Cable outlet Ø 9 mm with cable grip - it allows the passage of cables from Ø 4 mm to Ø 8 mm - 1 module</p>	3,11	10	100	
		<p>□ 441013      ■ 449013</p> <p>Tappo copriforo - pretranciatura posteriore centrale per agevolare eventuali fori - 1 modulo</p> <p>Blank insert - central pre-cut in rear side to facilitate any holes - 1 module</p>	1,17	10	300	
		<p>□ 441013R      ■ 449013R</p> <p>Tappo copriforo attrezzabile - pretranciatura posteriore centrale per agevolare eventuali fori - 1/2 modulo</p> <p>Equippable blank insert - central pre-cut in rear side to facilitate any holes - 1/2 module</p>	2,80	12	72	
		<p>□ 441013A/2      ■ 449013A/2</p> <p>Tappo copriforo attrezzabile - predisposizione per aggancio a involucro vuoto - 2 moduli</p> <p>Equippable blank insert - preset for clipping it to empty base - 2 modules</p>	2,54	4	24	
		<p>□ 441013A/3</p> <p>Tappo copriforo attrezzabile - predisposizione per aggancio a involucro vuoto - 3 moduli</p> <p>Equippable blank insert - preset for clipping it to empty base - 3 modules</p>	3,99	2	14	
		<p>□ 441S0</p> <p>Mostrina sporgente per alloggiamento sonde varie (temperatura, umidità, ecc.) - 1 modulo</p> <p>Prominent blank insert for various probe types (temperature, humidity, etc.) installation - 1 module</p>	6,06	1	1	

**Nota:** a richiesta potrà essere fornito l'involucro per l'aggancio al tappo copriforo 441013A/2 e 445013A/3  
**Note:** the base for the 441013A/2 and 445013A/3 blank insert clipping can be supplied upon request



441013A/3



441S0

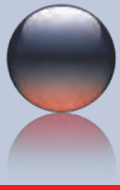

## Serie Domus - Class

Domus - Class series

Prese di corrente e speciali  
Standard and special socket outlets



BREVETTO AVE N° 254 MODELLO COMUNITARIO  
AVE PATENT N° 254 EU MODEL

90

AVE presenta un innovativo monoblocco multiprese con brevetto Ave. Una novità assoluta sul mercato che permette di integrare, anche nella tradizionale scatola da incasso a tre moduli, fino a 4 combinazioni: una presa bipasso, una presa schuko, una presa USB tipo A e una presa USB tipo C (uscita 3A).

La velocità di installazione è un altro grande vantaggio di questo prodotto.

È sufficiente un singolo cablaggio per collegare il dispositivo e dotare un punto-prese fino a 4 combinazioni.

AVE presents an innovative multi-socket monobloc with AVE patent. An absolute novelty on the market which allows to integrate up to 4 combinations also in the traditional three-module flush-mounted box: a combined Italian standard socket, a schuko socket, a USB type A socket and a USB type C socket (output 3A).

Speed of installation is another great advantage of this product.

A single cable is enough to connect the device and equip a socket-point with combinations up to 4 sockets.

Caratteristiche Tecniche Technical Features

# -50%

tempo di LAVORO

working time



# x2

produttività  
productivity

Il tutto in un'unica combinazione, installabili in scatole standard a 3 moduli uscita - USB 3A con utilizzo della singola presa  
All in a single combination, which can be installed in standard 3-module boxes - USB 3A output using the single socket



Per la disponibilità contattare la rete commerciale  
For availability please contact sales dept.



Disponibilità fino ad esaurimento scorte  
Available until stock out













Prodotto per scatola rettangolare inglese  
Product for British standard rectangular box



Prodotto per Export  
For Export only

## Prese di corrente e speciali Standard and special socket outlets





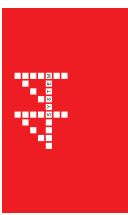

Domus	Class	Descrizione Description	Info	€	□	□
		<b>□ 44109015USB</b> Presa bipasso P17/11 2P+T 10/16A - Presa schuko bipasso P40 (UNIVERSALE) 2P+T 10/16A - alveoli schermati - USB 5V 1 uscita di tipo C - 1 uscita di tipo A - carico max in uscita 3A - 3 moduli <i>P17/11 2P+E 10/16A Combined Italian standard socket - P40 (UNIVERSAL) 2P+E 10/16A Schuko + Italian standard socket - shuttered - USB 5V - 1 type C outlet - 1 type A outlet - max output load 3A - 3 modules</i>		55,88	2	2
		<b>■ 44909015USB</b> Presa bipasso P17/11 2P+T 10/16A - Presa schuko bipasso P40 (UNIVERSALE) 2P+T 10/16A - alveoli schermati - USB 5V 1 uscita di tipo C - 1 uscita di tipo A - carico max in uscita 3A - 3 moduli <i>P17/11 2P+E 10/16A Combined Italian standard socket - P40 (UNIVERSAL) 2P+E 10/16A Schuko + Italian standard socket - shuttered - USB 5V - 1 type C outlet - 1 type A outlet - max output load 3A - 3 modules</i>	 	55,88	2	2
		<b>□ 44109015MB</b> Presa bipasso P17/11 2P+T 10/16A - Presa schuko bipasso P40 (UNIVERSALE) 2P+T 10/16A - alveoli schermati - 3 moduli <i>P17/11 2P+E 10/16A Combined Italian standard socket - P40 (UNIVERSAL) 2P+E 10/16A Schuko + Italian standard socket - shuttered - 3 modules</i>		24,97	3	30
		<b>■ 44909015MB</b> Presa bipasso P17/11 2P+T 10/16A - Presa schuko bipasso P40 (UNIVERSALE) 2P+T 10/16A - alveoli schermati - 3 moduli <i>P17/11 2P+E 10/16A Combined Italian standard socket - P40 (UNIVERSAL) 2P+E 10/16A Schuko + Italian standard socket - shuttered - 3 modules</i>	 	24,97	3	30

91



Sistema 45

## Prese di corrente standard esteri Various standards socket outlets

Domus	Class	Descrizione Description	Info	€	□	□
		<b>□ 44103392MB</b> Presa polarizzata euroamericana 2P 16A 250V~ più presa standard francese 2P+T 16A 250V~, alveoli schermati - 3 moduli <i>2P 16A 250V~ Euro-American polarized socket + 2P+E 16A 250V~ French standard socket, shielded sockets - 3 modules</i>	 	17,95	3	30
		<b>□ 44103392USB</b> Presa polarizzata euroamericana 2P 16A 250V~ più presa standard francese 2P+T 16A 250V~, alveoli schermati - USB 5V 1 uscita tipo C - 1 uscita di tipo A - carico max in uscita 3A - 3 moduli <i>2P 16A 250V~ Euro-American polarized socket + 2P+E 16A 250V~ French standard socket, shielded sockets - USB 5V 1 type C output - 1 type A output - max output load 3A - 3 modules</i>	 	52,99	2	2



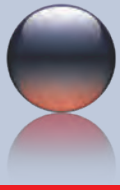

# Serie Domus - Class

Domus - Class series



Prese di corrente standard italiano 250V~  
250V~ Italian standard socket outlets

Caratteristiche Tecniche Technical Features

## Prese Standard Italiano Italian Standard Socket Outlets

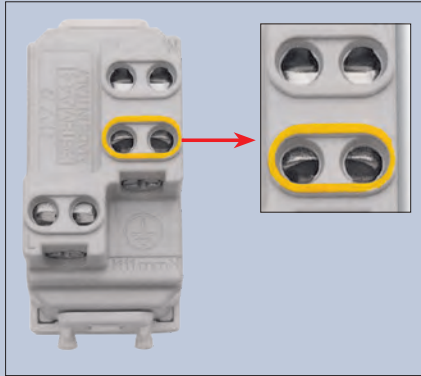

Morsetto di terra evidenziato per un'immediata identificazione  
Earth terminal highlighted for immediate identification

2 prese cablate con ponticello isolato  
2 sockets wired with insulated jumper



## Prese Schuko Schuko Socket Outlets

Presca con sportello Socket with lid

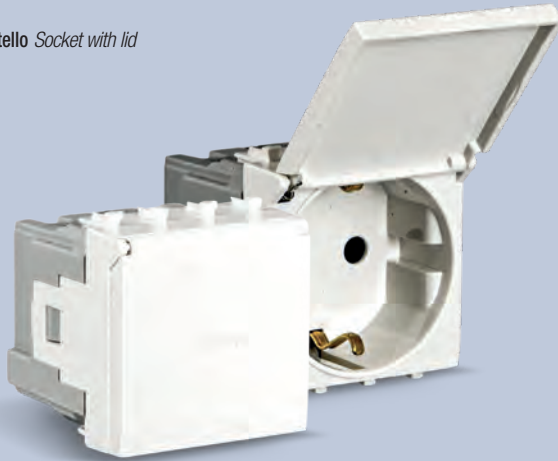

Presca illuminata Illuminated socket outlet

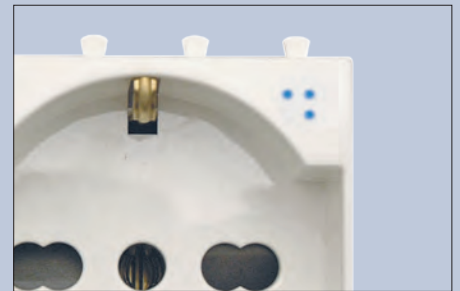

Consigliato l'utilizzo di Lampada a led colore blu (cod. 0230LDB)  
It is recommended the use of blue colour led lamp (code 0230LDB)

## Prese Schuko bipasso Combined Schuko + Italian standard socket

Prese Schuko  
Schuko Sockets

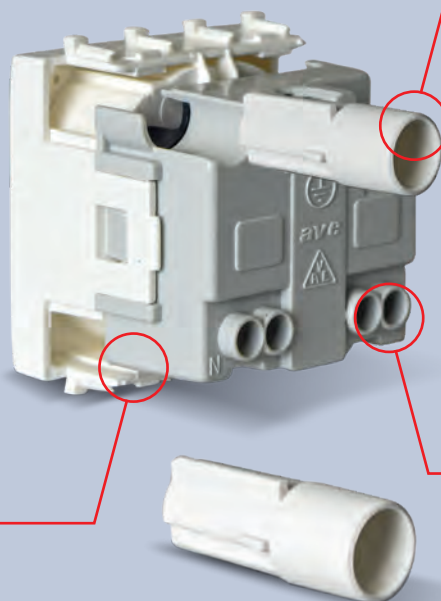

Adattatore per lampada di segnalazione  
Adaptor for led lamp

Ingombro ridotto  
Reduced footprint

Collare consente l'ingresso del doppio puntale per il filo da 2,5 mm  
This terminal allows an easy entry of the double tip for 2.5mm wire



Per la disponibilità contattare la rete commerciale  
For availability please contact sales dept.



Disponibilità fino ad esaurimento scorte  
Available until stock out



Prodotto per scatola rettangolare inglese  
Product for British standard rectangular box



Prodotto per Export  
For Export only

Prese di corrente standard italiano 250V~  
250V~ Italian standard socket outlets

Domus	Class	Descrizione Description	Info	€	<input type="checkbox"/>	<input type="checkbox"/>
		<input type="checkbox"/> <b>441006/15TS</b> <input checked="" type="checkbox"/> <b>449006/15TS</b> Presse bipasso P17/11 2P+T 10/16A - alveoli schermati - possibilità di utilizzo del ponticello isolato cod. 442PONTE per il cablaggio rapido di più prese affiancate - 1 modulo <i>Combined P17/11 Italian standard socket 2P+E 10/16A - shuttered - possibility of using insulated jumper code 442PONTE for rapid wiring of more sockets side by side 1 module</i>		6,55	10	100
441006/15TS	449006/15TS	<input type="checkbox"/> <b>441006TS</b> <input checked="" type="checkbox"/> <b>449006TS</b> Presse P11 2P+T 10A - alveoli schermati - possibilità di utilizzo del ponticello isolato cod. 442PONTE per il cablaggio rapido di più prese affiancate - 1 modulo <i>P11 2P+E 10A socket - shuttered - possibility of using insulated jumper code 442PONTE for rapid wiring of more sockets side by side - 1 module</i>		6,13	10	100
		<input type="checkbox"/> <b>441090TS</b> <input checked="" type="checkbox"/> <b>449090TS</b> Presse schuko P30 2P+T 16A - alveoli schermati - illuminabile (segnalazione presenza rete) - contatti di terra laterale e centrale - 2 moduli <i>P30 2P+E 16A Schuko socket - shuttered - lightable (indicating the presence of the line) - lateral and central earth contacts - 2 modules</i>		11,48	5	50
441006TS	449006TS	<input type="checkbox"/> <b>441090TSS</b> <input checked="" type="checkbox"/> <b>449090TSS</b> Presse schuko P30 2P+T 16A con sportello - alveoli schermati - contatti di terra laterale e centrale - 2 moduli <i>P30 2P+E 16A Schuko socket with lid - shuttered - lateral and central earth contacts - 2 modules</i>		12,54	5	50
		<input type="checkbox"/> <b>441090/15TS</b> <input checked="" type="checkbox"/> <b>449090/15TS</b> Presse schuko bipasso P40 (UNIVERSALE) 2P+T 10/16A - alveoli schermati - illuminabile (segnalazione presenza rete) - 2 moduli <i>2P+E 10/16A (UNIVERSAL) combined Schuko + Italian standard socket - shuttered - lightable (indicating the presence of the line) - 2 modules</i>		12,14	5	50
		<input type="checkbox"/> <b>4410690/15TS</b> Presse schuko P30 2P+T 16A combinata con 2 prese bipasso P17/11 2P+T 10/16 - alveoli schermati - 2 moduli <i>P30 2P+E 16A schuko socket with n. 2 P17/11 2P+E 10/16 combined sockets - shuttered - 2 modules</i>		17,65	1	10
		<input type="checkbox"/> <b>442PONTE</b> Ponticello isolato per cablaggio rapido di 2 prese affiancate standard italiano 1 modulo - unico blocco fase/terra/neutro - consigliato l'utilizzo con cavi di sezione 2,5 mm <sup>2</sup> o 4 mm <sup>2</sup> <i>Insulated jumper for rapid wiring of 2 Italian standard 1 module sockets side by side - single block phase/earth/neutral - it is recommended the use of 2,5 mm<sup>2</sup> or 4 mm<sup>2</sup> cables</i>		0,99	50	50
441090/15TS	449090/15TS					
4410690/15TS						
442PONTE						

Nota: gli articoli illuminabili sono forniti senza lampada di segnalazione  
Note: lightable articles are supplied without lamp

Presse per rasoi 240V~ 240V~ shaver socket

Domus	Class	Descrizione Description	Info	€	<input type="checkbox"/>	<input type="checkbox"/>
		<input type="checkbox"/> <b>441033RS</b> <input checked="" type="checkbox"/> <b>449033RS</b> Presse per rasoi con trasformatore di isolamento 20VA - standard euroamericano - alimentazione 240V~ - tensione prelevabile in uscita selezionabile tramite commutatore 240V~ o 120V~ - alveoli schermati - 3 moduli <i>Shaver socket with 20VA insulating transformer - Euro-American standard - 240V~ input - selectable output voltage 240V~ or 120V~ - shuttered - 3 modules</i>		104,57	1	1
441033RS						
	449033RS					

Nota: la presa è munita di dispositivo di autoprotezione contro il sovraccarico  
Note: the socket is supplied with a built-in surge protection device

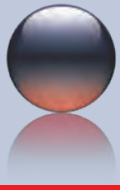

# Serie Domus - Class

Domus - Class series



Prese di corrente per linee dedicate 250V~  
Socket outlets for dedicated circuits 250V~

Caratteristiche Tecniche Technical Features

## Campo di applicazione prevalente *Predominant field of application*

**Rosso:**  
Linee alimentate da sistema statico di continuità UPS  
*Red:*  
Line powered by a UPS



**Verde:**  
Linee alimentate da rete/gruppo elettrogeno  
*Green:*  
Line powered by a network/power unit



**Arancione:**  
Linee alimentate da rete/gruppo elettrogeno e trasformatore di isolamento  
*Orange:*  
Line powered by a network/power unit and insulation transformer

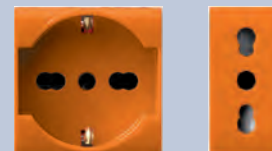

**Nota: esempi di impiego puramente indicativi non esistendo prescrizioni normative specifiche**  
*Nota: the above examples are purely indicative as no specific standard regulations are available*









☎ Per la disponibilità contattare la rete commerciale  
For availability please contact sales dept.

⌚ Disponibilità fino ad esaurimento scorte  
Available until stock out

# Prodotto per scatola rettangolare inglese  
Product for British standard rectangular box

⚠ Prodotto per Export  
For Export only

Prese di corrente per linee dedicate 250V~  
Socket outlets for dedicated circuits 250V~

		Descrizione Description	Info	€	<input type="checkbox"/>	<input type="checkbox"/>
		<p>■ <b>442006/15TSR</b>            Presa bipasso P17/11 2P+T 10/16A - alveoli schermati - rossa - possibilità di utilizzo del ponticello isolato cod. 442PONTE per il cablaggio rapido di più prese affiancate - 1 modulo  <i>Combined P17/11 Italian standard socket 2P+E 10/16A - shuttered - red - possibility of using insulated jumper code 442PONTE for rapid wiring of more sockets side by side - 1 module</i></p>		9,39	10	100
442006/15TSR	442090/15TSR					
		<p>■ <b>442006/15TSV</b>            Presa bipasso P17/11 2P+T 10/16A - alveoli schermati - verde - possibilità di utilizzo del ponticello isolato cod. 442PONTE per il cablaggio rapido di più prese affiancate - 1 modulo  <i>Combined P17/11 Italian standard socket 2P+E 10/16A - shuttered - green - possibility of using insulated jumper code 442PONTE for rapid wiring of more sockets side by side - 1 module</i></p>		9,39	10	100
442006/15TSV	442090/15TSV					
		<p>■ <b>442006/15TSA</b>            Presa bipasso P17/11 2P+T 10/16A - alveoli schermati - arancione - possibilità di utilizzo del ponticello isolato cod. 442PONTE per il cablaggio rapido di più prese affiancate - 1 modulo  <i>Combined P17/11 Italian standard socket 2P+E 10/16A - shuttered - orange - possibility of using insulated jumper code 442PONTE for rapid wiring of more sockets side by side - 1 module.</i></p>		9,39	10	100
442006/15TSA	442090/15TSA					
		<p>■ <b>442090TSR</b>            Presa schuko P30 2P+T 16A - alveoli schermati - rossa - illuminabile (segnalazione presenza rete) - contatti di terra laterale e centrale - 2 moduli  <i>P30 2P+E 16A Schuko socket - shuttered - red - lighttable (indicating the line presence) - lateral and central earth contacts - 2 modules</i></p>		13,85	5	50
442090TSR						
		<p>■ <b>442090/15TSR</b>            Presa schuko bipasso P40 (UNIVERSALE) 2P+T 10/16A - alveoli schermati - rossa illuminabile (segnalazione presenza rete) - 2 moduli  <i>2P+E 10/16A (UNIVERSAL) Schuko + Italian standard socket - shuttered - red lighttable (indicating the line presence) - 2 modules</i></p>		16,98	5	50
	442090/15TSA	<p>■ <b>442090/15TSA</b>            Presa schuko bipasso P40 (UNIVERSALE) 2P+T 10/16A - alveoli schermati - arancione illuminabile (segnalazione presenza rete) - 2 moduli  <i>2P+E 10/16A (UNIVERSAL) Schuko + Italian standard socket - shuttered - orange - lighttable (indicating the line presence) - 2 modules</i></p>		16,98	5	50
	442092TSR	<p>■ <b>442092TSR</b>            Presa standard francese 2P+T 16A - alveoli schermati - rossa - con terra - illuminabile (segnalazione presenza rete) - 2 moduli  <i>2P+E 16A French standard socket - shuttered - red - with earth - lighttable (indicating the line presence) - 2 modules</i></p> <p><b>Nota:</b> gli articoli illuminabili sono forniti senza lampada di segnalazione  <b>Nota:</b> lighttable articles are supplied without lamp</p>		14,13	5	50

Sistema 45

















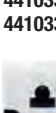



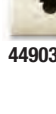











# Serie Domus - Class

Domus - Class series



Prese di corrente standard esteri  
Various standards socket outlets

96

Domus	Class	Descrizione Description	Info	€	□ □
 441033	 449033	□ 441033      ■ 449033 Presse polarizzata euroamericana 2P 16A 250V~ - alveoli non schermati - 1 modulo <i>2P 16A 250V~ Euro-American polarized socket - not shuttered - 1 module</i>	△ 	6,85	10 100
 441033S	 449033S	□ 441033S      ■ 449033S Presse polarizzata euroamericana 2P 16A 250V~ - alveoli schermati - 1 modulo <i>2P 16A 250V~ Euro-American polarized socket - shuttered - 1 module</i>	△ 	7,38	10 100
 441033TD	 449033TD	□ 441033TD      ■ 449033TD Presse polarizzata euroamericana 2P+T 16A 127~/250V~ - con terra laterale - alveoli non schermati - 1 modulo <i>2P+E 16A 127~/250V~ Euro-American polarized socket -with lateral earth - not shuttered - 1 module</i>	△ 	9,06	10 100
 441034S		□ 44103392MB Presse polarizzata euroamericana 2P 16A 250V~ più prese standard francese 2P+T 16A 250V~, alveoli schermati - 3 moduli <i>2P 16A 250V~ Euro-American polarized socket + 2P+E 16A 250V~ French standard socket, shielded sockets - 3 modules</i>	△  	17,95	3 30
 441034S	 449034S	□ 44103392USB Presse polarizzata euroamericana 2P 16A 250V~ più prese standard francese 2P+T 16A 250V~, alveoli schermati - USB 5V 1 uscita tipo C - 1 uscita di tipo A - carico max in uscita 3A - 3 moduli <i>2P 16A 250V~ Euro-American polarized socket + 2P+E 16A 250V~ French standard socket, shielded sockets - USB 5V 1 type C output - 1 type A output - max output load 3A - 3 modules</i>	△  	52,99	2 2
 441059TS	 449059TS	□ 441034S Presse 2P 16A 250V~ - alveoli Ø 4,8 mm - alveoli schermati - possibilità di utilizzo del ponticello isolato cod. 442PONTE per il cablaggio rapido di più prese affiancate - 1 modulo <i>2P 16A 250V~ - pins with 4,8 mm diameter - shuttered - possibility of using insulated jumper code 442PONTE for rapid wiring of more sockets side by side - 1 module</i>	△ 	5,31	10 100
 441090S	 449090S	□ 441059TS      ■ 449059TS Presse multistandard 2P+T 5/6/10/13A 250V~ - alveoli schermati - 2 moduli <i>2P+E 5/6/10/13A 250V~ multistandard socket - shuttered - 2 modules</i>	△ 	11,52	10 10
 441090SS	 449090SS	□ 441090S      ■ 449090S Presse standard tedesco 2P+T 16A 250V~ - alveoli schermati - illuminabile (segnalazione presenza rete) - 2 moduli <i>2P+E 16A 250V~ German standard socket - shuttered - lighttable (indicating the presence of the line) - 2 modules</i>	△	12,03	5 50
 441092TS	 449092TS	□ 441090SS      ■ 449090SS Presse standard tedesco 2P+T 16A 250V~ con sportello - alveoli schermati - da utilizzare in scatole con profondità minima 45 mm - 2 moduli <i>2P+E 16A 250V~ German standard socket with lid - shuttered - to be used in boxes with min. depth 45 mm - 2 modules</i>	△	14,96	5 50
 441092TSS	 449092TSS	□ 441092TS      ■ 449092TS Presse standard francese 2P+T 16A 250V~ - alveoli schermati - con terra - illuminabile (segnalazione presenza rete) - 2 moduli <i>2P+E 16A 250V~ French standard socket - shuttered - with earth - lighttable (indicating the presence of the line) - 2 modules</i>	△	11,48	5 50
 441092TSS	 449092TSS	□ 441092TSS      ■ 449092TSS Presse standard francese 2P+T 16A 250V~ con sportello - alveoli schermati - con terra - da utilizzare in scatole con profondità minima 45 mm - 2 moduli <i>2P+E 16A 250V~ French standard socket with lid - shuttered - to be used in boxes with min. depth 45 mm - 2 modules</i>	△	12,80	5 50

**Note:** ✓ 44..033, 44..033S, 44..033TD, 44..033TD2/3, 44..034, 44..034S, 44..059TS, 44..098T2/3 utilizzabili solo in paesi non membri dell'Unione Europea  
✓ gli articoli illuminabili sono forniti senza lampada di segnalazione

**Notes:** ✓ 44..033, 44..033S, 44..033TD, 44..033TD2/3, 44..034, 44..034S, 44..059TS, 44..098T2/3 must be used only in non-EU Countries

✓ the lighttable articles are supplied without lamp



Per la disponibilità contattare la rete commerciale  
For availability please contact sales dept.



Disponibilità fino ad esaurimento scorte  
Available until stock out









Prodotto per scatola rettangolare inglese  
Product for British standard rectangular box



Prodotto per Export  
For Export only



## Prese di corrente standard esteri Various standards socket outlets



Domus	Class	Descrizione Description	Info	€	□	□
		<input type="checkbox"/> 441097TS <input checked="" type="checkbox"/> 449097TS Presa standard inglese BS1363 2P+T 13A 250V~ - alveoli schermati - illuminabile (segnalazione presenza rete) - 2 moduli <i>2P+E 13A 250V BS1363 British standard socket - shuttered - lighttable (indicating the presence of the line) - 2 modules</i>	△	15,10	5	50
441097TS	449097TS	<input type="checkbox"/> 441097TS/5A Presa standard inglese BS546 2P+T 5A 250V~ - alveoli schermati - illuminabile (segnalazione presenza rete) - 2 moduli <i>2P+E 5A 250V BS546 British standard socket - shuttered - lighttable (indicating the presence of the line) - 2 modules</i>	△	11,68	5	50
		<input type="checkbox"/> 441098T2/3 Doppia presa polarizzata standard americano 2P+T 15A 127V~ - 3 morsetti (non necessario l'utilizzo di cavallotti) - alveoli non schermati - 3 moduli <i>2P+E 15A 127V~ American standard double polarized socket - 3 terminals (U-brackets not necessary) - not shuttered - 3 modules</i>	△ 	15,13	2	2
441097TS/5A	441098T2/3	<input type="checkbox"/> 441023T Presa standard svizzero tipo 23 con pozzetto 2P+T 16A 250V~ - alveoli non schermati 1,5 moduli <i>Swiss standard type 23 socket 2P+E 16A 250V~ - unshuttered - 1,5 modules</i>	△	9,15	7	70
						
441023T						

97





Sistema 45

## Prese per usi speciali e caricatori USB universali Socket outlets for special uses and Universal USB chargers

Domus	Class	Descrizione Description	Info	€	□	□
		<input type="checkbox"/> 441082USB3A <input checked="" type="checkbox"/> 449082USB3A Caricatore USB universale 5V 3A - n° 1 uscita USB frontale - alimentazione 110÷240V~ 50-60 Hz - assorbimento a riposo < 0,1 W - consente la ricarica di telefoni cellulari, riproduttori audio portatili, console portatili e ogni altro apparecchio elettronico che offra la possibilità di ricarica da una qualsiasi presa standard USB - 1 modulo <i>Universal USB charger 5V 3A - 1 frontal USB output - powered with 110÷240V~ 50-60 Hz - stand-by consumption &lt; 0,1 W - It allows the charging of mobile phones, mobile audio player, and all electronic devices with charging system through standard USB Inputs - 1 module</i>		28,46	1	1
441082USB3A	449082USB3A	<input type="checkbox"/> 441082USBAC Alimentatore USB 5V con 1 uscita di tipo C, 1 uscita di tipo A - alimentazione 110÷230V~ 50-60 Hz - assorbimento a riposo < 0,1 W - carico max in uscita 3A. 1 modulo <i>USB charger - 5V - 1 type C and 1 type A output - powered with 110÷230V~ 50-60 Hz - stand-by consumption &lt; 0,1 W - maximum output load 3A - 1 module</i>		37,46	1	1
						
441082USBAC						

## Prese telefoniche Telephone socket outlets

Domus	Class	Descrizione Description	Info	€	□	□
		<input type="checkbox"/> 441024 <input checked="" type="checkbox"/> 449024 Presa telefonica RJ11 (6 poli / 4 contatti) - morsetti a vite - 1 modulo <i>RJ11 telephone socket (6 poles / 4 contacts)- screw terminals - 1 module</i>		18,84	1	12
441024	449024	<input type="checkbox"/> 441026K Presa telefonica standard inglese "BT SECONDARY" (6 contatti) - morsetti a vite - 1 modulo <i>"BT SECONDARY" telephone socket (6 contacts) - screw terminals - 1 module</i>	△	12,65	2	2
						
441026K						

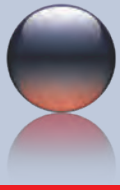

# Serie Domus - Class

Domus - Class series

NEW WIRING ACCESSORIES

Prese dati  
Data socket outlets

## Cablaggio universale T568A e T568B Universal wiring T568A and T568B

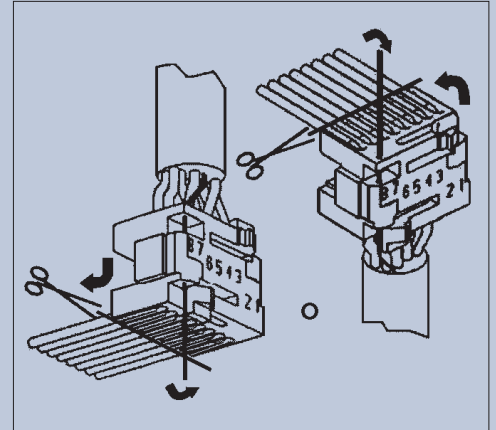
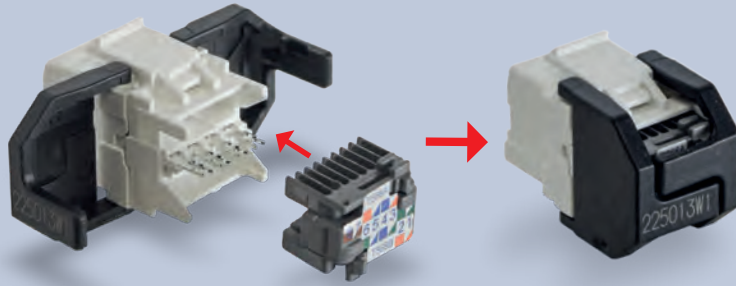

Non necessita di apposito attrezzo per i conduttori  
The special tool for conductors is not required

Caratteristiche Tecniche Technical Features

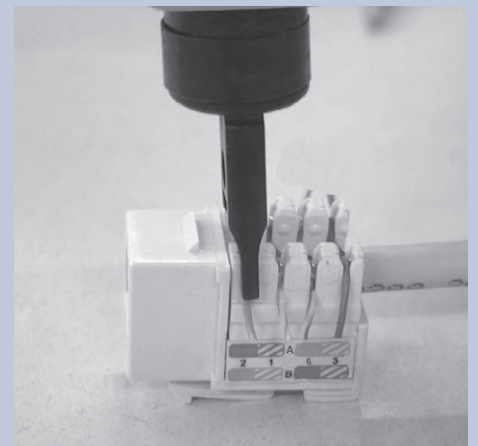

Connettori Ave, usare l'apposito attrezzo per premere i conduttori  
Ave connectors, use the special tool to press the conductors

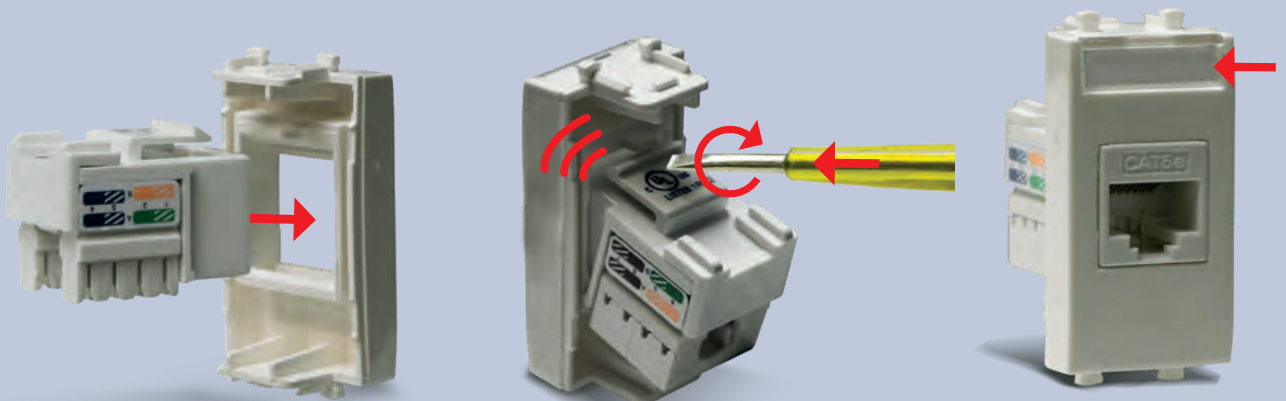

Aggancio  
Coupling

Sgancio  
Uncoupling

Cartellino identificativo  
Identification card

☎ Per la disponibilità contattare la rete commerciale  
For availability please contact sales dept.

🕒 Disponibilità fino ad esaurimento scorte  
Available until stock out

# Prodotto per scatola rettangolare inglese  
Product for British standard rectangular box

△ Prodotto per Export  
For Export only

Prese dati  
Data socket outlets

Domus	Class	Descrizione Description	Info	€	<input type="checkbox"/>	<input type="checkbox"/>
		<input type="checkbox"/> 441027C5E <input checked="" type="checkbox"/> 449027C5E Presse RJ45 categoria 5 enhanced - non schermata - morsetti ad incisione d'isolante - cablaggio universale T568A e T568B - 8 contatti - 1 modulo <i>RJ45 category 5 enhanced outlet - not shuttered - insulation piercing terminals - T568A and T568B universal wiring - 8 contacts - 1 module</i>		11,70	1	10
441027C5E	449027C5E	<input type="checkbox"/> 441027C6 <input checked="" type="checkbox"/> 449027C6 Presse RJ45 categoria 6 - non schermata - connettore AVE - morsetti ad incisione d'isolante - cablaggio universale T568A e T568B - 8 contatti - 1 modulo <i>RJ45 category 6 outlet - not shuttered - AVE connector - insulation piercing terminals - T568A and T568B universal wiring - 8 contacts - 1 module</i>		14,10	1	10
		<input type="checkbox"/> 441027C7S <input checked="" type="checkbox"/> 449027C7S Presse RJ45 categoria 7 - schermata - connettore AVE - morsetti ad incisione d'isolante - cablaggio universale T568A e T568B - 8 contatti - 1 modulo <i>RJ45 category 7 outlet - shuttered - AVE connector - insulation piercing terminals - T568A and T568B universal wiring - 8 contacts - 1 module</i>		21,24	1	10
441027C6	449027C6	<input type="checkbox"/> 441029C5E Presse RJ45 categoria 5 enhanced - non schermata - connettore 3M - morsetti ad incisione d'isolante con cablaggio rapido - cablaggio universale T568A e T568B - 8 contatti - sportellino antipolvere integrato nel connettore - 1 modulo <i>RJ45 category 5 enhanced outlet - not shuttered - 3M connector - insulation piercing terminals with rapid wiring - T568A and T568B universal wiring - 8 contacts - anti-dust lid integrated in the connector - 1 module</i>		24,39	1	10
		<input type="checkbox"/> 441029C6 Presse RJ45 categoria 6 - non schermata - connettore 3M - morsetti ad incisione d'isolante con cablaggio rapido - cablaggio universale T568A e T568B - 8 contatti - sportellino antipolvere integrato nel connettore - 1 modulo <i>RJ45 category 6 outlet - not shuttered - 3M connector - insulation piercing terminals with rapid wiring - T568A and T568B universal wiring - 8 contacts - anti-dust lid integrated in the connector - 1 module</i>		25,89	1	10
441027C7S	449027C7S	<input type="checkbox"/> 441029C6S Presse RJ45 categoria 6 - schermata - connettore 3M - morsetti ad incisione d'isolante con cablaggio rapido - cablaggio universale T568A e T568B - 8 contatti - sportellino antipolvere integrato nel connettore - 1 modulo <i>RJ45 category 6 outlet - shuttered - 3M connector - insulation piercing terminals with rapid wiring - T568A and T568B universal wiring - 8 contacts - anti-dust lid integrated in the connector - 1 module</i>		31,32	1	10
		<input type="checkbox"/> 441029C6AS <input checked="" type="checkbox"/> 449029C6AS Presse RJ45 categoria 6a FTP - schermata - morsetti ad incisione d'isolante con cablaggio rapido - cablaggio universale T568A e T568B - 8 contatti - sportellino antipolvere integrato nel connettore - 1 modulo <i>RJ45 category 6a FTP outlet - shuttered - AVE connector - insulation piercing terminals with rapid wiring - T568A and T568B universal wiring - 8 contacts - anti-dust lid integrated in the connector - 1 module</i>		29,53	1	10
441029C5E	441029C6					
441029C6S						
441029C6AS	449029C6AS					

**Nota:** previsto, nella parte superiore, vetrino trasparente e relativo cartellino per consentire all'installatore/utente l'identificazione del tipo di presa  
**Note:** on the upper part there is a transparent glass with card to allow the installer/user to identify the outlet type

Adattatori per connettori RJ45 e connettori di segnale AVE Adaptors for RJ45 connectors and AVE signal connectors

Domus	Class	Descrizione Description	Info	€	<input type="checkbox"/>	<input type="checkbox"/>
		<input type="checkbox"/> 441029SC <input checked="" type="checkbox"/> 449029SC Adattatore per connettori RJ45 3M, AT&T, CEAM-QUBIX, KRONE, CLIPSAL, AMPHENOL, FANTON o connettori AVE RJ11, RJ45, RCA, TV, ecc. - 1 modulo <i>Adaptor for RJ45 3M, AT&amp;T, CEAM-QUBIX, KRONE, CLIPSAL, AMPHENOL, FANTON or AVE RJ11, RJ45, RCA, TV, etc. connectors - 1 module</i>		5,86	4	4
441029SC	449029SC	<input type="checkbox"/> 441030SC <input checked="" type="checkbox"/> 449030SC Adattatore per connettori RJ45 AMP, RSX, BRAND-REX - 1 modulo <i>Adaptor for RJ45 AMP, RSX, BRAND-REX connectors - 1 module</i>		5,86	4	4
		<input type="checkbox"/> 441029SC/2C Adattatore per n° 2 connettori AVE TV, RCA, BNC, USB, HDMI - 1 modulo <i>Adaptor for n. 2 AVE TV, RCA, BNC, USB, HDMI connectors - 1 module</i>		6,04	4	4
441030SC	449030SC					

Le dimensioni, salvo diversamente specificato, sono in mm  
Dimensions, except where otherwise specified, are in mm

Imballo Minimo pcs  
Min. Packaging pcs

Imballo Standard pcs  
Std. Packaging pcs



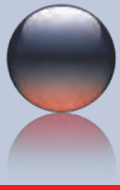

# Serie Domus - Class

Domus - Class series



Prese TV/SAT  
TV/SAT socket outlets

100

## Prese TV passanti *Through line TV outlet*

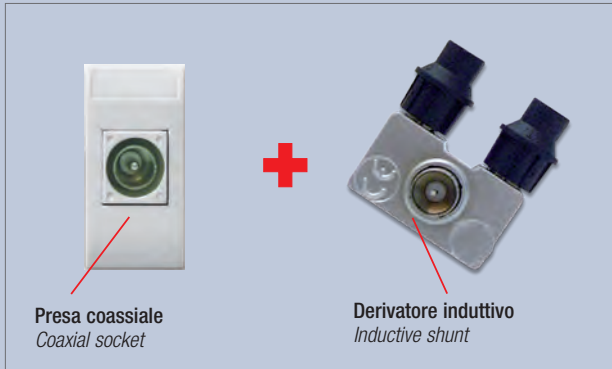

## Vista laterale *Side view*

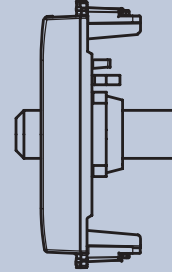

Applicazione etichetta adesiva per diversificazione TV/SAT Domus  
*Application of sticky label for diversification Domus TV/SAT*



Applicazione cartellino per diversificazione TV/SAT Tekla  
*Application of the card to diversify Tekla TV/SAT*

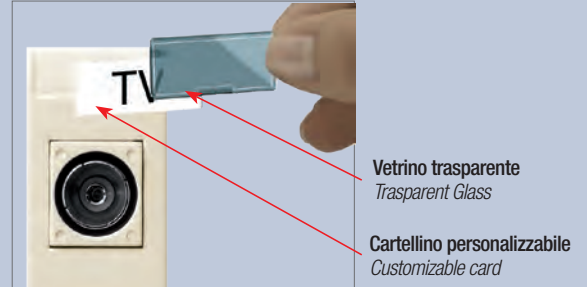

## CAP

### Collegamento *Connection*

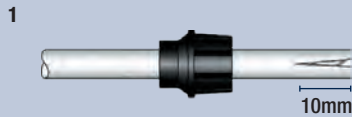

Taglio trasversale guaina  
*Cross cut on sheath*



Ripiegamento calza  
*Fold back braiding*

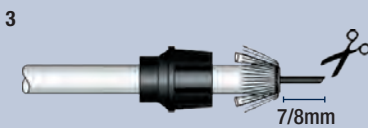

Taglio del dielettrico e del conduttore centrale a 45°  
*45° cut of the dielectric and central conductor*

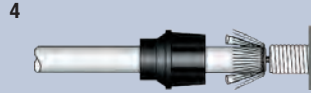

Inserzione conduttore centrale su connettore F femmina  
*Insert central conductor on F-type female connector*

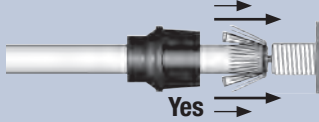
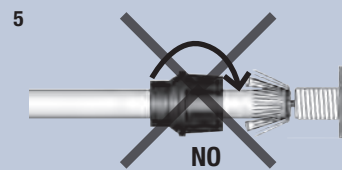

Inserzione CAP (non avvitando)  
*Insert CAP (do not screw)*

### Estrazione *Extraction*

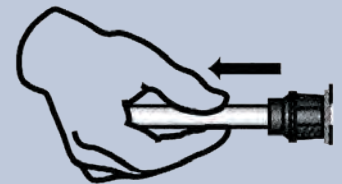

Per la disponibilità contattare la rete commerciale  
For availability please contact sales dept.



Disponibilità fino ad esaurimento scorte  
Available until stock out



Prodotto per scatola rettangolare inglese  
Product for British standard rectangular box



Prodotto per Export  
For Export only



Prese TV/SAT con CAP - Ø 9,5 mm - Accessori  
TV/SAT socket outlets - Ø 9,5 mm - Accessories

Domus	Class	Descrizione Description	Info	€	□	□
		<p>□ 441096IM      ■ 449096IM</p> <p>Presse coassiale TV/SAT diretta con porta utente IEC 60169-2 maschio per frequenze fino a 2400 MHz - collegamento in ingresso mediante connettore maschio tipo F - fornita con connettore plastico (CAP) per la connessione in ingresso del cavo coassiale - fornita con etichette adesive TV/SAT - 1 modulo TV/SAT direct coaxial socket with IEC 60169-2 male connector for frequencies until 2400 MHz - incoming connection through F male connector - supplied with plastic connector (CAP) for coaxial cable connection - supplied with sticky labels TV/SAT - 1 module</p>		11,38	1	12
		<p>□ 441096F      ■ 449096F</p> <p>Presse coassiale TV/SAT diretta con porta utente femmina tipo F per frequenze fino a 2400 MHz - collegamento in ingresso e in uscita mediante connettore maschio tipo F - fornita con connettore plastico (CAP) per la connessione in ingresso del cavo coassiale - fornita con etichette adesive TV/SAT - 1 modulo TV/SAT direct coaxial socket with F female connector for frequencies until 2400 MHz - incoming and outgoing connection through F male connector - supplied with plastic connector (CAP) for coaxial cable connection - supplied with sticky labels TV/SAT - 1 module</p>		11,68	1	12
		<p>□ 441096IF      ■ 449096IF</p> <p>Presse coassiale TV/SAT diretta con porta utente IEC 60169-2 femmina per frequenze fino a 2400 MHz - collegamento in ingresso mediante connettore maschio tipo F - fornita con connettore plastico (CAP) per la connessione in ingresso del cavo coassiale - fornita con etichette adesive TV/SAT - 1 modulo TV/SAT direct coaxial socket with IEC 60169-2 female connector for frequencies until 2400 MHz - incoming connection through F male connector - supplied with plastic connector (CAP) for coaxial cable connection - supplied with sticky labels TV/SAT - 1 module</p>		11,70	2	12
		<p>□ 441096DM      ■ 449096DM</p> <p>Presse TV - SAT diretta demiscelata, 2 uscite con connettore maschio (TV) e connettore tipo F (SAT) - per frequenze 5-2400 MHz - attenuazione di derivazione 1dB - permette il passaggio di corrente continua e segnali di controllo (24V 500mA max) - collegamento in ingresso mediante morsetto a vite - 1 modulo TV/SAT demixed direct socket, 2-outputs with male connector (TV) and type F (SAT) connector - for frequencies 5-2400 MHz - attenuation 1dB - it allows the passage of direct current and control signals (24V 500mA max) - incoming connection with screw terminal - 1 module</p>		28,85	1	1
		<p><b>TVDER-DB6</b></p> <p>Derivatore induttivo TV/SAT ad innesto su presa 44..096IM, 44..096IF, 44..096F - attenuazione di derivazione 6dB TV/SAT inductive shunt to be connected to 44..096IM, 44..096IF, 44..096F - attenuation 6dB</p>		10,31	1	6
		<p><b>TVDER-DB10</b></p> <p>Derivatore induttivo TV/SAT ad innesto su presa 44..096IM, 44..096IF, 44..096F - attenuazione di derivazione 10dB TV/SAT inductive shunt to be connected to 44..096IM, 44..096IF, 44..096F - attenuation 10dB</p>		10,09	1	6
		<p><b>TVDER-DB14</b></p> <p>Derivatore induttivo TV/SAT ad innesto su presa 44..096IM, 44..096IF, 44..096F - attenuazione di derivazione 14dB TV/SAT inductive shunt to be connected to 44..096IM, 44..096IF, 44..096F - attenuation 14dB</p>		10,09	1	6



TVDER-DB6  
TVDER-DB10  
TVDER-DB14

**Nota:** TVDER-DB... permettono la trasformazione delle prese 44..096IM, 44..096IF, 44..096F da dirette a passanti  
**Note:** TVDER-DB... allow to change the 44..096IM, 44..096IF, 44..096F sockets from direct to through line

Presse TV/SAT Ø 9,5 mm TV/SAT socket outlet Ø 9,5 mm

Domus	Descrizione Description	Info	€	□	□
	<p>□ 441096FE</p> <p>Presse TV femmina IEC 60169-2 - per frequenze 4÷2400 MHz - collegamento in ingresso mediante morsetto a vite - 1 modulo Female TV socket IEC 60169-2 - for frequencies 4÷2400 MHz - input connection through screw terminals - 1 module</p>	△	5,94	10	10

441096FE









# Serie Domus - Class

Domus - Class series





Presse TV/SAT Ø9,5 mm  
TV/SAT socket outlet Ø 9,5 mm



102

Domus	Class	Descrizione Description	Info	€	□	□
		<p>□ 441096M/DB6    ■ 449096M/DB6</p> <p>Presse TV/SAT passante con porta utente IEC 60169-2 maschio - per frequenze 4÷2400 MHz - attenuazione di derivazione 6dB - collegamento in ingresso mediante morsetto a vite - 1 modulo</p> <p><i>Through-line TV/SAT outlet with male IEC 60169-2 connector - for frequencies 4÷2400 MHz - attenuation 6dB - input connection through screw terminal - 1 module</i></p>		24,83	1	1
441096M/DB6	449096M/DB6					
441096M/DB10	449096M/DB10	<p>□ 441096M/DB10    ■ 449096M/DB10</p> <p>Presse TV/SAT passante con porta utente IEC 60169-2 maschio - per frequenze 4÷2400 MHz - attenuazione di derivazione 10dB - collegamento in ingresso mediante morsetto a vite - 1 modulo</p> <p><i>Through-line TV/SAT outlet with male IEC 60169-2 connector - for frequencies 4÷2400 MHz - attenuation 10dB - input connection through screw terminal - 1 module</i></p>		24,83	1	1

Presse TV/SAT Ø 9,5 mm TV/SAT socket outlet Ø 9,5 mm

Domus	Class	Descrizione Description	Info	€	□	□
		<p>□ 441096M    ■ 449096M</p> <p>Presse TV/SAT diretta con porta utente IEC 60169-2 maschio - per frequenze 4÷2400 MHz - attenuazione di derivazione 1dB - permette il passaggio di corrente continua e segnali di controllo (24V 300mA max) - collegamento in ingresso mediante morsetto a vite - fornita con etichette adesive TV/SAT - 1 modulo</p> <p><i>Direct TV/SAT socket with male IEC 60169-2 connector - for frequencies 4÷2400 MHz - attenuation 1dB - it allows the passage of direct current and control signals (24V 300mA max) input connection through screw terminals - supplied with TV/SAT adhesive labels - 1 module</i></p>		17,09	1	10
441096M	449096M					

Prese TV/SAT con 2 e 3 porte utente TV/SAT socket outlets with 2 and 3 connectors

Domus	Class	Descrizione Description	Info	€	□	□
		<p>□ 441096/2PU</p> <p>Presse TV-FM/SAT diretta - non demiscelata - 2 porte utente con connettori maschio e femmina IEC 60169-2 - per frequenze 4÷2400 MHz - attenuazione di derivazione 5dB - permette il passaggio di corrente continua e segnali di controllo (24V 300mA max) attraverso il connettore femmina - collegamento in ingresso mediante morsetto a vite - 2 moduli</p> <p><i>Direct TV-FM/SAT - not demixed - duplex socket with IEC 60169-2 male and female connectors - frequency range 4÷2400 MHz - Attenuation 5dB - it allows the passage of direct current and control signals (24V 300mA max) through the female connector - Incoming connection with screw terminal - 2 modules</i></p>		46,72	1	6
441096/2PU						
		<p>□ 441096/3PU    ■ 449096/3PU</p> <p>Presse TV-FM-SAT diretta - demiscelata - 3 porte utente con connettore TV IEC 60169-2 maschio, connettore radio IEC 60169-2 femmina, connettore SAT tipo F femmina - per frequenze 4÷2400 MHz - attenuazione di derivazione 1dB - permette il passaggio di corrente continua e segnali di controllo (24V 300mA max) attraverso il connettore F femmina - collegamento in ingresso mediante morsetto a vite - 2 moduli</p> <p><i>Direct TV-FM-SAT - demixed triplex socket with IEC 60169-2 male TV connector, IEC 60169-2 female radio connector and SAT female F-type connector - frequency range 4÷2400 MHz - Attenuation 1dB - it allows the passage of direct current and control signals (24V 300mA max) through the female F-type connector - incoming connection with screw terminal - 2 modules</i></p>		62,74	1	6
441096/3PU	449096/3PU					

**Nota:** 44..096/3PU per un ottimale funzionamento della presa tutte le uscite devono essere utilizzate  
**Note:** 44..096/3PU for a perfect functioning of the socket, all the connectors must be used



Per la disponibilità contattare la rete commerciale  
For availability please contact sales dept.



Disponibilità fino ad esaurimento scorte  
Available until stock out







Prodotto per scatola rettangolare inglese  
Product for British standard rectangular box



Prodotto per Export  
For Export only

## Interruttori automatici magnetotermici 120-230V~ MCB 120-230V~





Domus	Class	Descrizione Description	Info	€	□	□
		<b>□ 441052X6</b> Interruttore automatico magnetotermico 1P+N 6A 120-230V~ p.i. 1,5kA potenza dissipata 1,2W - 1 modulo <i>MCB 1P+N 6A 120-230V~ b.c. 1,5kA - dissipated power 1,2W - 1 module</i>		68,33	1	10
441052X6		<b>□ 441052X10</b> <b>■ 449052X10</b> Interruttore automatico magnetotermico 1P+N 10A 120-230V~ p.i. 3kA potenza dissipata 1W - 1 modulo <i>MCB 1P+N 10A 120-230V~ b.c. 3kA - dissipated power 1W - 1 module</i>		70,41	1	10
 	449052X10	<b>□ 441052X16</b> Interruttore automatico magnetotermico 1P+N 16A 120-230V~ p.i. 3kA potenza dissipata 2,1W - 1 modulo <i>MCB 1P+N 16A 120-230V~ b.c. 3kA dissipated power 2,1W - 1 module</i>  <b>Nota:</b> magnetotermici curva C <b>Note:</b> MCB type C		71,06	1	10
						
441052X16						

103



Sistema 45

## Interruttori automatici magnetotermici differenziali 120-230V~ SRCBO 120-230V~

Domus	Class	Descrizione Description	Info	€	□	□
		<b>□ 441062X6</b> Interruttore automatico magnetotermico differenziale 1P+N 6A 120-230V~ $I_{\Delta n}$ 10mA p.i. 1,5kA - potenza dissipata 1,3W - 2 moduli <i>SRCBO 1P+N 6A 120-230V~ <math>I_{\Delta n}</math> 10mA b.c. 1,5kA - dissipated power 1,3W - 2 modules</i>		163,01	1	6
441062X6		<b>□ 441062X10</b> <b>■ 449062X10</b> Interruttore automatico magnetotermico differenziale 1P+N 10A 120-230V~ $I_{\Delta n}$ 10mA p.i. 3kA - potenza dissipata 1,1W - 2 moduli <i>SRCBO 1P+N 10A 120-230V~ <math>I_{\Delta n}</math> 10mA b.c. 3kA - dissipated power 1,1W - 2 modules</i>		163,01	1	6
 	449062X10	<b>□ 441062X16</b> Interruttore automatico magnetotermico differenziale 1P+N 16A 120-230V~ $I_{\Delta n}$ 10mA p.i. 3kA - potenza dissipata 2,5W - 2 moduli <i>SRCBO 1P+N 16A 120-230V~ <math>I_{\Delta n}</math> 10mA b.c. 3kA - dissipated power 2,5W - 2 modules</i>  <b>Note:</b> ✓ prevedono una segnalazione frontale di alimentazione e contatto chiuso a mezzo led colore verde ✓ magnetotermici curva C - differenziali tipo A  <b>Notes:</b> ✓ frontal signal of power supply and closed contact through a green led ✓ MCB type C - SRCBO type A		179,51	1	6
						
441062X16						

## Interruttori differenziali puro 120-230V~ RCD 120-230V~

Domus	Descrizione Description	Info	€	□	□
	<b>□ 441062X16/30MA</b> Interruttore differenziale puro 2P 16A 120-230V~ $I_{\Delta n}$ 30mA - potenza dissipata 2,5W - 2 moduli <i>RCD 2P 16A 120-230V~ <math>I_{\Delta n}</math> 30mA - dissipated power 2,5W - 2 modules</i>		221,71	1	6
441062X16/30MA	<b>Note:</b> ✓ prevede una segnalazione frontale di alimentazione e contatto chiuso a mezzo led colore verde ✓ differenziale tipo A  <b>Notes:</b> ✓ frontal signal of power supply and closed contact through a green led ✓ RCD type A				

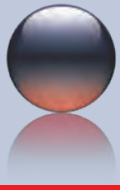

# Serie Domus - Class

Domus - Class series



Relè di chiamata  
Call Relays

Caratteristiche Tecniche Technical Features

## Schema di Collegamento 44..087C Connection Diagram 44..087C

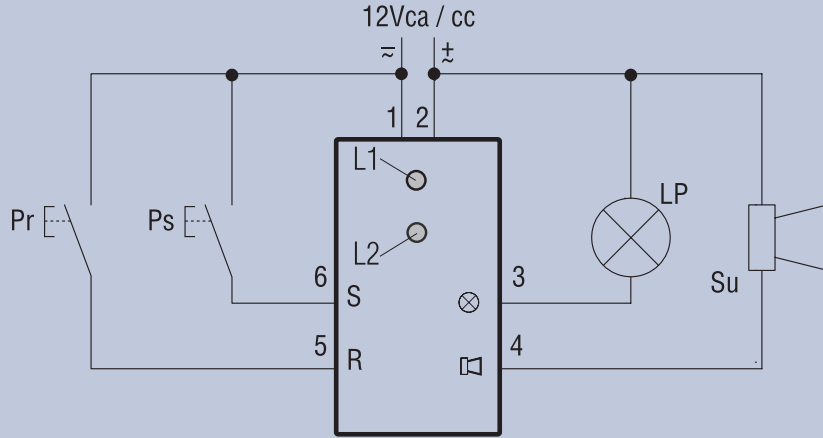

**Nota:** ✓ per il corretto funzionamento del relè è necessario prevedere un trasformatore 12 Vca oppure un alimentatore 12 Vcc opportunamente dimensionati  
 ✓ se il relè è alimentato in corrente alternata la tensione efficace sui carichi (lampada e suoneria) è pari alla metà della tensione di alimentazione

**Note:** ✓ for the proper functioning of the relay it is necessary to provide a transformer 12 Vac or a power supply 12 Vdc appropriately sized  
 ✓ If the relay is powered in alternating current, the RMS voltage on the loads (lamp and sounder) is equal to the half of powering voltage.

## Relè di Chiamata - Sistema di Chiamata Call Relay - Call System

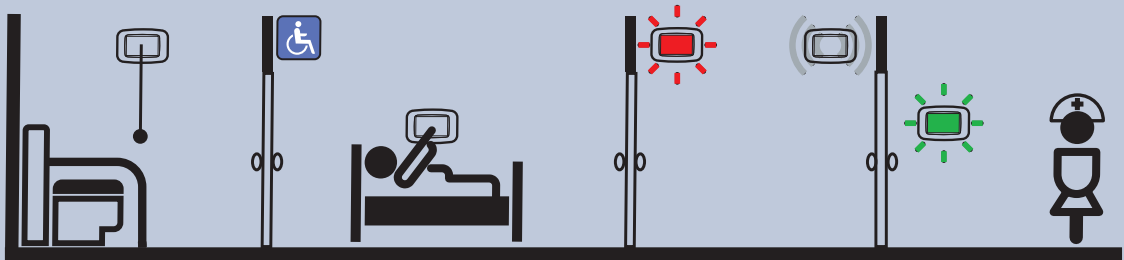

Il paziente agendo sul pulsante effettua una chiamata. Il relè attiva le segnalazioni ottiche ed acustiche nel corridoio e la segnalazione ottica in reception corrispondente al numero del chiamante

By pressing a push button the patient makes a call. The relay activates the visual and sound signals in the corridor and the visual signal at reception corresponding to the caller's number



L'infermiera intervenendo nella camera del paziente effettua l'azione di reset agendo sul pulsante posto nella camera stessa, annullando l'attivazione delle segnalazioni ottiche ed acustiche

The nurse is summoned to the patient's room and can reset by pressing the push-button in the room, cancelling the visual and sound signals.



Per la disponibilità contattare la rete commerciale  
For availability please contact sales dept.



Disponibilità fino ad esaurimento scorte  
Available until stock out





Prodotto per scatola rettangolare inglese  
Product for British standard rectangular box



Prodotto per Export  
For Export only

## Relè di chiamata Call Relays

Domus	Class	Descrizione Description	Info	€	□	□
 441087C	 449087C	<p>□ 441087C      ■ 449087C</p> <p>Relè statico bistabile (tipo Flip-Flop SR) 12Vca/cc per impianti di chiamata - 2 uscite: per segnalazione ottica (lampeggiante o fissa) e per segnalazione acustica (suono continuo o temporizzato da 3 secondi a 1 minuto) - attivazione e tacitazione da più punti con normali pulsanti NA collegati in parallelo - 1 modulo</p> <p><i>Static bistable relay (type Flip-Flop SR) 12Vca/cc for call systems - 2 outputs: for visual signals (flashing or fixed) and acoustic signals (continuous sound or at intervals of 3 seconds to 1 minute) - activated and silenced from various points using normal NO push buttons connected in parallel - 1 module</i></p>		139,78	1	1
		<p><b>KITCHIAMADOMUS</b></p> <p>Kit base per sistema di chiamata d'emergenza</p> <p>La confezione contiene:</p> <ul style="list-style-type: none"> <li>- n° 1 441087C relè per impianti di chiamata 12Vca/cc;</li> <li>- n° 1 441081 segnalatore ausiliario d'allarme 86dB 12÷24Vca/cc;</li> <li>- n° 1 441082ALI alimentatore 230Vca/12Vcc 5W;</li> <li>- n° 1 442076 spia di segnalazione sporgente (lampadina esclusa);</li> <li>- n° 1 0212LDW/E10HI lampada a led con fili 12-24Vca/cc(per art. 441050);</li> <li>- n° 1 441050 pulsante 1P NA 10A con scritta "RESET" sull'etichetta di segnalazione;</li> <li>- n° 1 441017 pulsante 1P NA+NC 10A a tirante;</li> <li>- n° 3 44A03 supporti con viti per scatole rettangolari 3 moduli</li> </ul> <p><i>Basic kit for emergency call</i></p> <p>The package includes:</p> <ul style="list-style-type: none"> <li>- n° 1 441087C static bistable relay</li> <li>- n° 1 441081 auxiliary alarm signal</li> <li>- n° 1 441082ALI flush mounted power supply</li> <li>- n. 1 442076 prominent lamp holder (bulb excluded);</li> <li>- n. 1 0212LDW/E10HI led signalling lamp with wires 12-24Vca/cc (for art. 441050);</li> <li>- n° 1 441050 1P NO 10A 250V lightable push-button "RESET" label on the diffuser</li> <li>- n° 1 441017 1P NO+NC 10A cord operated push-button</li> <li>- n° 3 44A03 frame with screws for rectangular box</li> </ul>		336,95	1	1



KITCHIAMA...

Integrabili nel Sistema  
Can be integrated with the system



**Note:** per ulteriori informazioni vedere paragrafo "suonerie elettroniche"

**Notes:** for further information, see the "electronic ringtones" paragraph



Sistema 45







# Serie Domus - Class

Domus - Class series







Suonerie / Ronzatori elettromeccanici  
Bells / Buzzers

106

Domus	Class	Descrizione Description	Info	€	□	□
 441028 441029	 449028 449029	<p>□ 441028      ■ 449028 Suoneria squillante 12V~ 8VA (SELV) - 1 modulo <i>Ringing bell 12V~ 8VA (SELV) - 1 module</i></p> <p>□ 441029      ■ 449029 Suoneria squillante 230V~ - 1 modulo <i>Ringing bell 230V~ - 1 module</i></p>		25,34	1	10
 441030 441031	 449030 449031	<p>□ 441030      ■ 449030 Ronzatore 12V~ 8VA (SELV) - 1 modulo <i>Buzzer 12V~ 8VA (SELV) - 1 module</i></p> <p>□ 441031      ■ 449031 Ronzatore 230V~ - 1 modulo <i>Buzzer 230V~ - 1 module</i></p>		19,64	1	10
<p><b>Nota:</b> Utilizzare solo per servizio ad intermittenza. Tempo massimo di utilizzo continuo 5" con relativa pausa di 15"</p> <p><i>Note: Use only for intermittent service. Maximum time of continuous use 5 " with relative pause of 15"</i></p>						

## Suonerie elettroniche Electronic bells

Domus	Descrizione Description	Info	€	□	□
 441081	<p>□ 441081 Segnalatore ausiliario d'allarme con possibilità di temporizzazione suoneria per 5 secondi - alimentazione 12-24 Vcc/ca - possibilità regolazione intensità sonora - pressione acustica 86 dB a 1m - led frontale di segnalazione - 1 modulo <i>Auxiliary alarm signal - possibility of setting a timer to ring for 5 second-12s depending on input voltage- input 12-24 Vac/dc - it is possible to adjust the sound volume - acoustic pressure 85 dB at 1m - front signalling led - 1 module</i></p>		59,84	1	10
 441083/2	<p>□ 441083/2 Suoneria elettronica tritonale - alimentazione 12 Vcc/ca - possibilità di scelta tra sei diversi suoni acustici - regolazione frontale intensità sonora - led frontale di segnalazione - pressione acustica 71÷76 dB a 1 m a seconda del suono attivato - 2 moduli <i>Three tone electronic bell - 12 Vac/dc power supply - possibility to choose one out of six acustics tones - frontal sound regulation - frontal signalling led - acoustic pressure 71÷76 dB at 1 m according to the sound activated - 2 modules</i></p>		116,94	1	6
 441083/2RS	<p>■ 441083/2RS Suoneria tritonale 12vcc per sistemi chiamata di emergenza colore rosso - assorbimento 160mA - possibilità scelta tra 3 tipologie di segnalazioni acustiche temporizzate che identificano le seguenti chiamate: <b>GENERICA - EMERGENZA - ALLARME</b> - regolazione frontale intensità sonora da 45 a 65 dB - led frontale - 2 moduli <i>12Vdc sounders for emergency call systems, red colour - 160mA absorption - Three different timed sound time options identifying following calls: <b>GENERIC - EMERGENCY - ALARM</b> - frontal trimmer for sound pressure adjustment from 45 to 65 dB - frontal led - 2 modules</i></p>		118,09	1	1
 AF442099RS	<p>■ AF442099RS Sirena da interni rossa per sistemi antifurto o avisatore acustico - alimentazione 12 Vcc - possibilità di impostazione di due livelli di intensità sonora - possibilità di scelta tra quattro diversi suoni acustici - pressione acustica 90 dB a 3 m - 2 moduli <i>Indoor siren for burglar alarm systems or acoustical device - 12 Vdc - power supply - possibility to set two different levels of acoustic intensity - possibility to choose among four different acoustic sounds - acoustic pressure 90 dB at 3m - 2 modules</i></p>		78,96	1	1



Per la disponibilità contattare la rete commerciale  
For availability please contact sales dept.



Disponibilità fino ad esaurimento scorte  
Available until stock out









Prodotto per scatola rettangolare inglese  
Product for British standard rectangular box



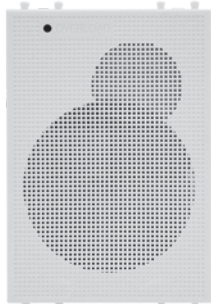

Prodotto per Export  
For Export only





## Diffusione sonora Sound diffusion

Domus	Descrizione Description	Info	€	□	□
 <b>442AP01</b>	<b>□ 441AP01</b> Diffusore acustico - impedenza 8 Ohm - potenza 5 W - protezione contro il sovraccarico con indicazione della limitazione a mezzo LED - fornito con due cornicette bianco Ral 9010 per utilizzo con placche 6 (3+3) mod.: una per placche Zama/Personal 44 (44P933... - 44P033...) e una per placche Vera 44 (44PV33... - 44PA33... - 44PL33...). La cornicetta deve essere applicata alla relativa placca dopo aver rimosso la cornicetta originale con traversino centrale fornita con la placca <i>Loudspeaker - 8 Ohm impedance - 5 W power - overload protection with LED indication - supplied with inner frames white Ral 9010 for use with plates 6(3+3) modules: one inner frame for Zama/Personal 44 plates (44P933.. - 44P033..) and one for Vera 44 plates (44PV33..- 44PA33.. -44PL33..). The inner frame must be installed after removing the original one supplied with the plate with the central crossbar</i>	82,98	1	1	
 <b>44A33</b> Supporto da utilizzare <i>To be used with</i>					
Scatole utilizzabili Available boxes  <b>BL02P</b> Pareti in muratura <i>Brickwork walls</i>	 <b>BL02CG</b> Pareti in cartongesso <i>Hollow walls</i>				
 <b>441DS01</b>	<b>□ 441DS01</b> Regolatore di volume mono per diffusori acustici - permette la regolazione del volume di un singolo altoparlante (canale DX o canale SX) senza interferire sul volume di altri diffusori installati nello stesso impianto - regolazione a 6 posizioni: OFF, 1, 2, 3, 4, 5 - 2 moduli <i>Mono volume controller for loudspeakers - It allows the control of an individual loudspeaker (left or right channel) with no interference on the volume of other loudspeakers installed in the same plant - regulation with 6 positions (OFF, 1, 2, 3, 4, 5) - 2 modules</i>	99,60	1	1	
 <b>441DS02</b>	<b>□ 441DS02</b> Regolatore di volume stereo per diffusori acustici - permette la regolazione simultanea del volume di una coppia di diffusori (canale DX e canale SX) senza interferire sul volume di altre coppie di diffusori installati nello stesso impianto - regolazione a 6 posizioni: OFF, 1, 2, 3, 4, 5 - completo di supporto per scatola 2503MG - 3 moduli <i>Stereo volume controller for loudspeakers - It allows simultaneous control of a pair of loudspeakers (left and right channels) with no interference on the volume of other pairs of loudspeakers installed in the same plant. Regulation with 6 positions (OFF, 1, 2, 3, 4, 5) - complete with frame for 2503MG box - 3 modules</i>	121,13	1	1	

## Portafusibili 250V~ Fuse Holders 250V~

Domus	Class	Descrizione Description	Info	€	□	□
 <b>441007</b>	 <b>449007</b>	<b>□ 441007</b> <b>■ 449007</b> Portafusibile per fusibili in miniatura 1P 10A - per fusibili Ø 5x20 mm - fornito senza fusibile - 1 modulo <i>Fuse holder for miniature fuses 1P 10A - for fuses Ø 5x20 mm - supplied without fuse - 1 module</i>	13,75	1	10	
 <b>441007/13A</b>		<b>□ 441007/13A</b> Portafusibile per fusibile BS1362 1P 13A - per fusibili Ø 6,3x28 mm - fornito con fusibile - 1 modulo <i>Fuse holder for BS1362 fuse 1P 13A - for fuses Ø 6,3x28 mm - supplied with fuse - 1 module</i>	13,18	1	10	

## Alimentatori Power supplies

Domus	Class	Descrizione Description	Info	€	□	□
 <b>441082ALI</b>	 <b>449082ALI</b>	<b>□ 441082ALI</b> <b>■ 449082ALI</b> Alimentatore supplementare da incasso - tensione di ingresso: 85÷265V~ 50-60Hz - tensione d'uscita 12 Vcc - corrente erogabile: 400mA a servizio continuo - 1 modulo <i>Additional flush mounted power supply - input voltage 85÷265V~ 50-60Hz - output voltage 12 Vdc - suppliable current: 400mA continuous - 1 module</i>	76,75	1	1	

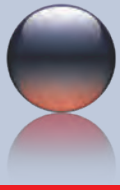

# Serie Domus - Class

Domus - Class series

Lampade  
Lights



Caratteristiche Tecniche Technical Features

## Lampade estraibili 44..086 Removable lights 44..086

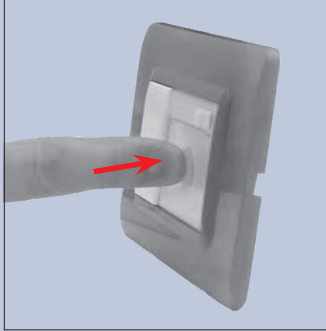

Estrazione lampada: premere sul fronte  
Light removal: push on the front

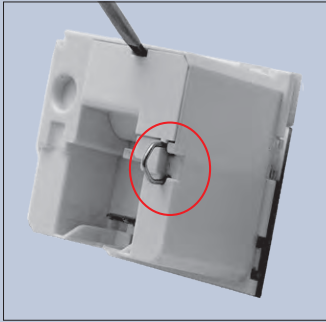
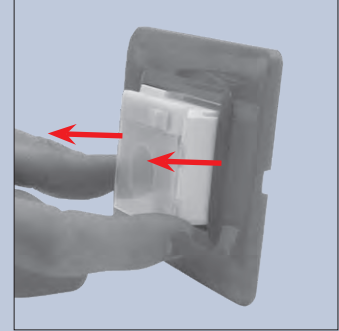
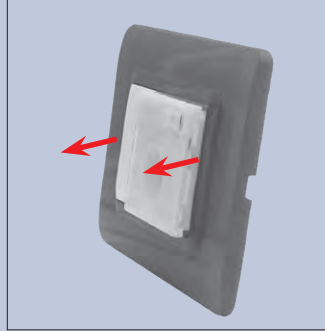

Gancio appendi-lampada  
Light clipping hook

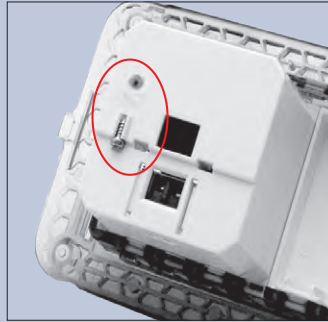

Vite per blocco estrazione lampada  
Light anti-removal screw

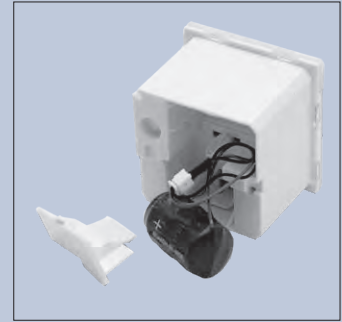

Sostituzione batteria  
Battery replacement

## Lampada di emergenza MULTICOMPATIBILE MULTI-COMPATIBLE emergency light

Installazione su scatole standard da 4 e 7 moduli  
Installation on 4 modules and 7 modules standard boxes

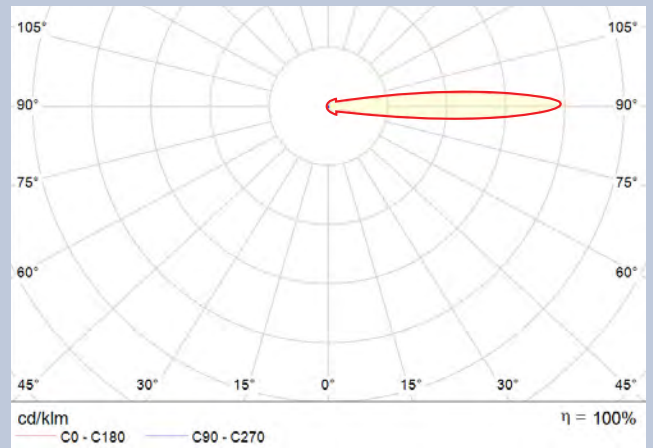

- Flusso luminoso 90 lumen
- Completa di supporto MULTICOMPATIBILE 6/7 moduli
- Installabile sia in scatole da incasso standard 6/7 moduli sia in 4 moduli
- Da completare con placche standard 7 moduli S44 di Ave o con analoghe placche di altri costruttori (Bticino Livinglight, Bticino Living International, Bticino Light, Vimar Eikon, Vimar Plana)
- placche Serie SMART NON INSTALLABILI
- Luminous flux 90 lumen
- Supplied with MULTICOMPATIBILE 6/7 modules frame
- It can be installed both in 6/7 modules standard flush mounted boxes and in 4 modules boxes
- To be completed with AVE S44, 7 mod front plates or with similar front plates by other manufacturers (Bticino Livinglight, Bticino Living International, Bticino Light, Vimar Eikon, Vimar Plana)
- SMART Series front plates NOT INSTALLABLE

Per la disponibilità contattare la rete commerciale  
For availability please contact sales dept.

Disponibilità fino ad esaurimento scorte  
Available until stock out





# Prodotto per scatola rettangolare inglese  
Product for British standard rectangular box

△ Prodotto per Export  
For Export only

## Lampada segnagrado e lampada estraibile portatile

### Step marker light and removable portable light

BREVETTO AVE N° 102  
MODELLO COMUNITARIO  
AVE PATENT N° 102

Domus	Class	Descrizione Description	Info	€	<input type="checkbox"/>	<input type="checkbox"/>
		<b>441070/1</b> <b>449070/1</b> Lampada segnagrado - alimentazione 12-24 Vcc/ca o 230 V~ - led colore bianco ad alta efficienza - 1 modulo <i>Step marker light - input 12-24 Vac/dc o 230 V~ - white led, high efficiency - 1 module</i>		40,01	1	10
441070/1	449070/1	<b>441086</b> <b>449086</b> Lampada anti black-out estraibile portatile - completa di base di ricarica - completa di batterie ricaricabili e sostituibili - lampada: led colore bianco ad alta efficienza - interruttore frontale per spegnimento in assenza tensione di rete - tempo di ricarica 36 ore - autonomia 3 ore circa - alimentazione 110-230 V~ - 2 moduli <i>Anti black out removable portable light - with recharging base - with interchangeable and rechargeable batteries - lamp: high efficiency white led - front switch in case of power failure - 36 hours recharge time - 3 hours endurance - 110-230 V~ power supply - 2 module</i>		106,53	1	1
		<b>45786B</b> Batteria (4x1,2)V - 80mAh, di ricambio per 44..086 <i>Spare battery for 44..086 (4x1,2)V - 80mAh</i>		14,82	1	1
441086	449086					



45786B

109



Sistema 45

## Lampada di emergenza MULTICOMPATIBILE MULTI-COMPATIBLE emergency light

Descrizione Description	Info	€	<input type="checkbox"/>	<input type="checkbox"/>
 <b>442089</b> Lampada di emergenza a LED bianchi ad alta efficienza 230 V~ 50/60 Hz - SE - assorbimento in stand-by 5 mA (340 mW) - batteria ricaricabile e sostituibile 3,7 V 700 mAh - tempo di ricarica 12 ore - autonomia 2 ore - autodiagnosi permanente della funzionalità della batteria con segnalazione luminosa in caso di anomalia - <b>flusso luminoso 90 lumen</b> - completa di supporto MULTICOMPATIBILE 6/7 moduli - <b>installabile sia in scatole da incasso standard 6/7 moduli sia in scatole 4 moduli</b> - da completare con placche standard 7 moduli S44 di Ave o con placche di altri costruttori (Bticino Livinglight, Bticino Living International, Bticino Light, Vimar Eikon, Vimar Plana) - <u>placche Serie SMART NON INSTALLABILI</u> - 4x7 moduli <i>Emergency light with a white high-efficiency LED 230 V ~ 50/60 Hz - N/M - absorption on stand-by 5 mA (340 mW) - Rechargeable and changeable battery: 3.7 V 700 mAh - Recharge time: 12 hours - 2 hours of endurance - permanent self-diagnosis of the battery functionality with warning light in case of failures - luminous flux 90 lumens - complete with MULTI-COMPATIBLE 6/7 modules frames - <b>installable in standard 6/7 modules flush mounted boxes or in 4 modules boxes</b> - to be completed with Ave S44 standard 7 modules front plates or plates from other manufacturers (Bticino Livinglight, Bticino Living International, Bticino Light, Vimar Eikon, Vimar Plana) - <u>SMART Series front plates NOT INSTALLABLE</u> - 4x7 modules</i>		109,97	1	1
<b>442089B</b> Batteria Li-Ion 3,7 V 700 mAh di ricambio per lampada d'emergenza 442089 <i>Spare battery Li-Ion 3,7 V 700 mAh for emergency light 442089</i>		32,15	1	1

**Nota:** Non installabili le placche di finitura della Gamma Smart  
*Note: The Smart Range finishing front plates cannot be installed*

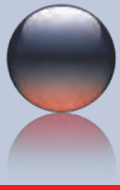

# Serie Domus - Class

Domus - Class series

Cronotermostato  
Chronothermostat



### MASSIME PRESTAZIONI per il RISPARMIO ENERGETICO:

- \* Differenziale termico minimo: vengono rilevate velocemente variazioni di temperatura in modo da evitare eccessive escursioni della temperatura ambiente controllata.
- \* Deriva sotto carico ridotta al minimo, ovvero la variazione tra la temperatura regolata quando il contatto del termostato è a vuoto e quando invece è a pieno carico elettrico.

### MAXIMUM PERFORMANCE for ENERGY SAVING:

- \* Minimum thermal differential: temperature variations are detected in order to avoid extreme room temperature oscillations
- \* Minimized on-duty offset, as to say the variation of the adjusted temperature between no load and full load operating conditions.

Caratteristiche Tecniche Technical Features



Ingresso comando da remoto  
Input for remote control

Contatto in scambio  
5A 250V  
switching  
contact 5A 250V

Tasti retro illuminati  
Backlighted controls

Set di temperatura al momento attivo a seconda del programma in corso:  
t1 Comfort o t2 Attività (precomfort) o t3 Economy (risparmio) o antigelo  
Temperature set currently active on the basis of the running program: T1 Comfort or T2 Activity (precomfort) or T3 Economy (saving) or antifreeze

Giorno, ora e minuti  
Day, hour and minutes

Completamente a filo placca  
Front plate levelness

Temperatura ambiente rilevata  
Detected room temperature

Scala oraria e termica programmata sulle 24 ore  
Hourly and thermal scale set up on 24 hours



Per la disponibilità contattare la rete commerciale  
For availability please contact sales dept.



Disponibilità fino ad esaurimento scorte  
Available until stock out







Prodotto per scatola rettangolare inglese  
Product for British standard rectangular box



Prodotto per Export  
For Export only



## Termostati Thermostats

Domus	Class	Descrizione Description	Info	€	<input type="checkbox"/>	<input type="checkbox"/>
		<p><input type="checkbox"/> 441085      <input checked="" type="checkbox"/> 449085</p> <p>Termostato elettronico a manopola per controllo temperatura ambiente - uscita con contatto in scambio NA+NC 5A (2A induttivi) 230V~ - range regolazione temperatura da 5 °C a 30 °C - alimentazione 230V~ 50-60 Hz - 2 moduli</p> <p><i>Electronic thermostat with rotary knob for room temperature control - switching contact output NO+NC 5A (2A inductive) - temperature range from 5 °C to 30 °C - 230V~ power supply - 50-60 Hz - 2 modules</i></p>		79,95	1	1
		<p><input type="checkbox"/> 441085SW      <input checked="" type="checkbox"/> 449085SW</p> <p>Termostato elettronico estate/inverno a display retroilluminato per controllo temperatura ambiente (riscaldamento e condizionamento) - uscita con contatto in scambio NA+NC 2A 230V~ - range regolazione temperatura da 0 °C a 35 °C - tasti di comando retroilluminati - ingresso per attivazione a distanza e ingresso per forzata a temperatura ridotta - alimentazione 230V~ 50-60 Hz - 2 moduli</p> <p><i>Electronic winter/summer thermostat with backlit display for room temperature control (heating and air-conditioning) - switching contact output NO+NC 2A 230V~ - temperature range from 0 °C to 35 °C - backlit controls - input for remote activation and input for forcing at reduced temperature - 230V~ power supply - 50-60 Hz - 2 modules</i></p>		156,40	1	1





111



Sistema 45

## Cronotermostati 230V~ Chronothermostats 230V~

Domus	Class	Descrizione Description	Info	€	<input type="checkbox"/>	<input type="checkbox"/>
		<p><input type="checkbox"/> 441CRT3      <input checked="" type="checkbox"/> 449CRT3</p> <p>Cronotermostato elettronico da incasso a filo placca, con display retroilluminato per controllo temperatura ambiente (riscaldamento e condizionamento) - programmazione giornaliera/settimanale uscita con contatto in scambio libero da potenziale NA+NC 5A 250V~ - range regolazione temperatura da 5 °C a 37 °C. Set di programmazione per inibizione pulizie - 4 tasti di comando retroilluminati - ingresso per attivazione a distanza - passaggio automatico all'ora legale/solare - menù con guida testuale multilingue - alimentazione 230V~ 50-60 Hz - 3 moduli.</p> <p><i>Flush-mounted (front plate levelness) electronic chronothermostat with backlit display for room temperature control (heating and air-conditioning) - daily/weekly programming - switching contact output NO+NC 5A 250V~ temperature control range: from 5 °C to 37 °C - programming set for cleaning inhibition - 4 backlit controls - input for remote control - automatic passage to daylight saving/solar time - menu with multilingual text guide - 230V~ power supply - 50-60 Hz - 3 modules</i></p>		189,21	1	1

## Cronotermostati 230V~ Chronothermostats 230V~

Class	Descrizione Description	Info	€	<input type="checkbox"/>	<input type="checkbox"/>
	<p><input checked="" type="checkbox"/> 449CRT</p> <p>Cronotermostato elettronico a display retroilluminato per controllo temperatura ambiente (riscaldamento e condizionamento) - programmazione giornaliera/settimanale - estraibile - uscita con contatto in scambio NA+NC 3A 230V~ - range regolazione temperatura da 0 °C a 35 °C - impostazione programmi su tre temperature (0 °C ÷ 35 °C) - correzione temperatura misurata con off-set +/-5 °C - programmazione a passi di 30 minuti - funzione antigrippaggio pompa - tasti di comando retroilluminati - ingresso per attivazione a distanza - passaggio automatico all'ora legale/solare - menù con guida testuale multilingue - alimentazione 230V~ 50-60 Hz - 2 moduli</p> <p><i>Electronic winter/summer chronothermostat with backlit display for room temperature control (heating and air-conditioning) - daily/weekly programming - removable - switching contact output NO+NC 3A 230V~ temperature control range: 0 °C ÷ 35 °C - programs setting on three temperature levels (0 °C ÷ 35 °C) - adjustment of temperature measured with offset +/-5 °C - programming in steps of 30 minutes - pump anti-seizing function - backlit controls - input for remote control - menu with multilingual text guide - automatic passage to daylight saving/solar time - 230V~ power supply - 50-60 Hz - 2 modules</i></p>		228,58	1	1





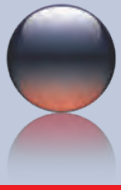

# Serie Domus - Class

Domus - Class series



## Caratteristiche Tecniche *Technical Features*



lampada di emergenza  
*emergency light*



torcia estraibile  
*removable torch*



segnapasso/gradino  
*step lights*



rivelatore di movimento  
*infrared motion detector*



Per la disponibilità contattare la rete commerciale  
For availability please contact sales dept.



Disponibilità fino ad esaurimento scorte  
Available until stock out



Prodotto per scatola rettangolare inglese  
Product for British standard rectangular box



Prodotto per Export  
For Export only

## Variatore per agitatori d'aria Dimmer for ceiling fan

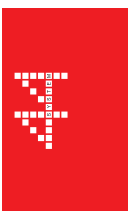

Domus	Descrizione Description	Info	€	□	□
 441048AA	<p><input type="checkbox"/> 441048AA</p> <p>Variatore a 3 velocità (+ spegnimento) 55÷80VA 230V~ 50-60Hz- comando con pulsante incorporato o da più punti con normali pulsanti NA - tecnologia che garantisce l'assoluta "silenziosità" - led di individuazione al buio - 1 modulo</p> <p><i>3-speed push button dimmer (+ switch off) 55÷80VA 230V~ 50-60Hz- control by built-in push-button or by normal NO push-button from more points - technology guaranteeing absolute "silence" - led for identification in the dark - 1 module</i></p>		85,03	1	6

113



Sistema 45

## Commutatore per fan-coil Rotary switch for fan-coil

Domus	Class	Descrizione Description	Info	€	□	□
 441055	 449055	<p><input type="checkbox"/> 441055    <input checked="" type="checkbox"/> 449055</p> <p>Commutatore rotativo 1P 3A 250V~ a 4 posizioni per variazione velocità fan-coil (ventilconvettori) - 2 moduli</p> <p><i>1P 3A 250V rotary switch 4 positions for fan coil (convectors) - 2 modules</i></p>		46,81	1	1

## Igrostato Hygrostat

Domus	Class	Descrizione Description	Info	€	□	□
 441079	 449079	<p><input type="checkbox"/> 441079    <input checked="" type="checkbox"/> 449079</p> <p>Igrostato (umidostato) elettronico a manopola - soglia di intervento regolabile tra 50% e 95% di Umidità Relativa - ingresso per comando esterno dell'uscita - uscita a relè con contatto in scambio libero da potenziale con doppio isolamento NA+NC 8(2)A 230V~ - alimentazione 230V~ 50-60 Hz - 2 moduli</p> <p><i>Electronic hygrostat (humidity regulator) with rotary knob - intervention threshold from 50% to 95% of relative humidity - input for external control - output relay with double insulation NO+NC 8(2)A 230V~ - power supply 230V~ 50-60 Hz - 2 modules</i></p>		134,19	1	1

## Regolatore di velocità per motori AC Speed controller for AC motors

Domus	Descrizione Description	Info	€	□	□
 441048M	<p><input type="checkbox"/> 441048M</p> <p>Regolatore di velocità per motori AC 4-200VA - accensione, spegnimento e regolazione a mezzo manopola frontale - possibilità di impostazione della velocità minima - led frontale giallo per indicazione stato carico - 2 moduli</p> <p><i>Speed controller for AC motors 4-200VA - on/off function and regulation by front knob - possibility of setting the minimum speed - Yellow front LED for load charge status - 2 modules</i></p>		86,27	1	1

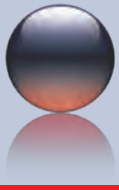

**Aggancio connettore ad adattatore** Connector clipping to the adapter

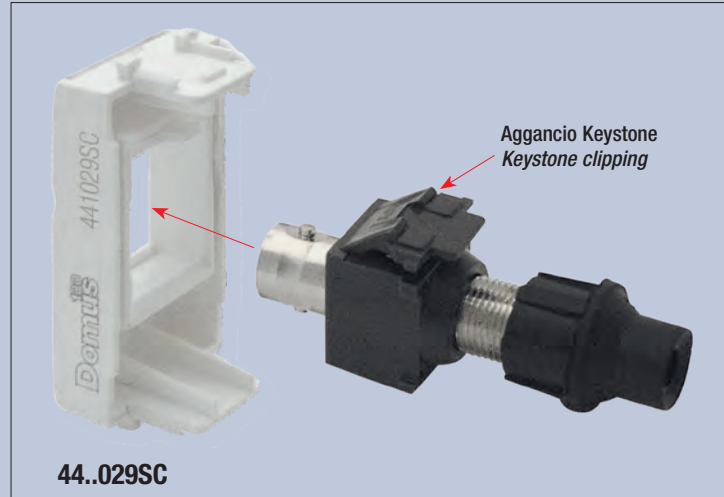

**Connettori di Segnale Ave** Ave Connectors

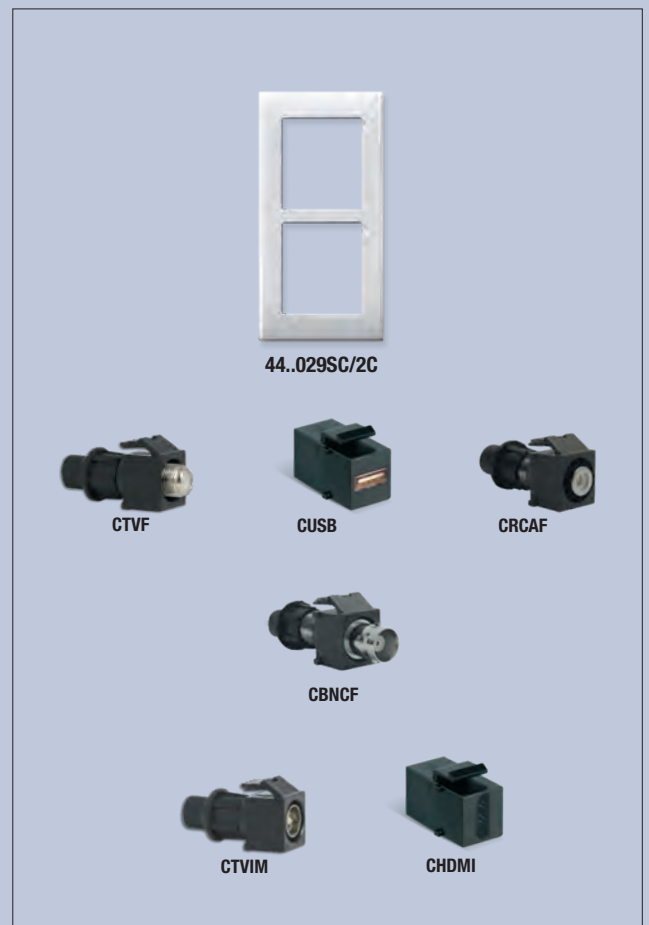
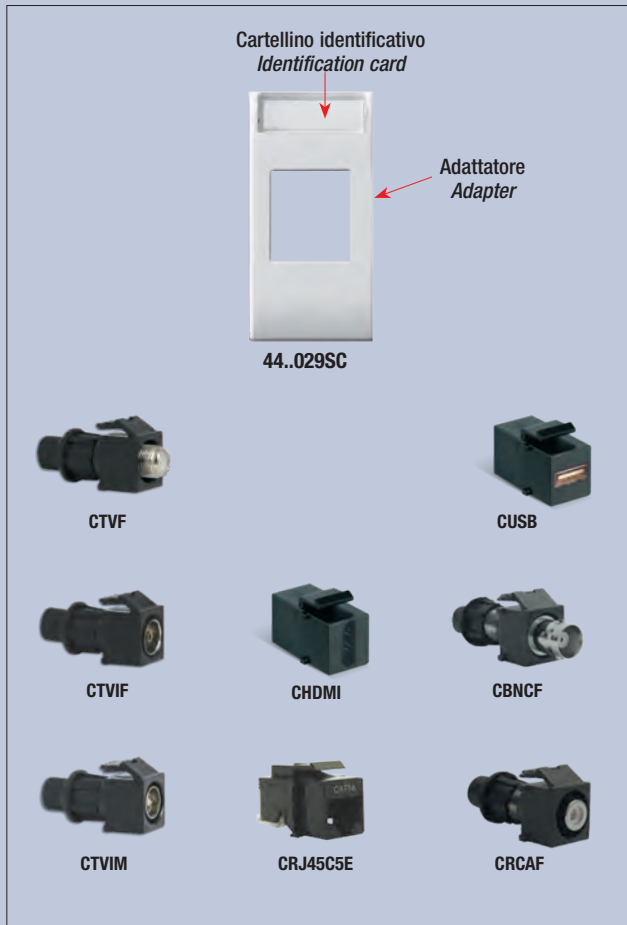

Tutti i connettori si installano su un unico adattatore cod. 441029SC - 445029SC  
All the connectors can be installed on the adapter code 441029SC - 445029SC

Connettori installabili su adattatore cod. 441029SC/2C - 445029SC/2C  
All the connectors that can be installed on the adapter code 441029SC/2C - 445029SC/2C



Per la disponibilità contattare la rete commerciale  
For availability please contact sales dept.



Disponibilità fino ad esaurimento scorte  
Available until stock out



Prodotto per scatola rettangolare inglese  
Product for British standard rectangular box



Prodotto per Export  
For Export only

## Connettori di Segnale Connectors

115

	Descrizione <i>Description</i>	Info	€	□	□
 CHDMI	<b>CHDMI</b> Connettore AVE HDMI femmina - collegamento in ingresso mediante connettore HDMI maschio - per connessioni video di alta qualità - utilizzo tipico con apparecchiature dotate di standard HDMI - installabile su adattatore cod. 44..029SC o 44..029SC/2C <i>AVE HDMI female connector - input connection through F-type male connector - for high quality video connections - typical use with HDMI standard devices - installable on adapter code 44..029SC or 44..029SC/2C</i>		16,26	2	2
 CRCAF	<b>CRCAF</b> Connettore AVE RCA femmina - collegamento in ingresso mediante connettore maschio tipo F - per connessioni audio in bassa frequenza - utilizzo tipico per collegamento altoparlanti - fornito con connettore plastico (CAP) per la connessione - installabile su adattatore cod. 44..029SC o 44..029SC/2C <i>AVE RCA female connector - input connection through F-type male connector - for low frequency audio connections - typical use for loudspeaker connections - supplied with (CAP) plastic connector - installable on adapter code 44..029SC or 44..029SC/2C</i>		7,43	5	5
 CRJ45C5E	<b>CRJ45C5E</b> Connettore AVE RJ45 categoria 5 enhanced - non schermato - morsetti ad incisione d'isolante - cablaggio rapido tramite accessorio fornito in dotazione - cablaggio universale T568A e T568B - 8 contatti - installabile su adattatore cod. 44..029SC <i>AVE RJ45 category 5 enhanced connector - not shuttered - insulation piercing terminals - supplied with accessory for rapid wiring - T568A and T568B universal wiring - 8 contacts - installable on adaptor code 44..029SC</i>		9,58	2	2
 CTVF	<b>CTVF</b> Connettore AVE TV/SAT tipo F femmina - collegamento in ingresso mediante connettore maschio tipo F - utilizzo tipico per collegamenti SAT- fornito con connettore plastico (CAP) per la connessione - installabile su adattatore cod. 44..029SC o 44..029SC/2C <i>AVE TV/SAT female type F connector - typical use for SAT connections - supplied with plastic connector (CAP) for the installation - installable on adapter code 44..029SC or 44..029SC/2C</i>		5,81	5	5
 CTVIF	<b>CTVIF</b> Connettore AVE TV/FM IEC femmina - collegamento in ingresso mediante connettore maschio tipo F - utilizzo tipico per collegamenti FM- fornito con connettore plastico (CAP) per la connessione - installabile su adattatore cod. 44..029SC o 44..029SC/2C <i>AVE TV/FM IEC female connector - typical use for TV connections - supplied with plastic connector (CAP) for the installation - installable on adapter code 44..029SC or 44..029SC/2C</i>		5,81	5	5
 CTVIM	<b>CTVIM</b> Connettore AVE TV/SAT IEC maschio - collegamento in ingresso mediante connettore maschio tipo F - utilizzo tipico per collegamenti TV digitale terrestre - fornito con connettore plastico (CAP) per la connessione - installabile su adattatore cod. 44..029SC o 44..029SC/2C <i>AVE TV/SAT IEC male connector - input connection through male connector type F - typical use for TV connections - supplied with plastic connector (CAP) for the installation - installable on adapter code 44..029SC or 44..029SC/2C</i>		5,81	5	5
 CUSB	<b>CUSB</b> Connettore AVE USB femmina - collegamento in ingresso mediante connettore USB maschio - per connessioni dati ad apparecchiature dotate di standard USB - installabile su adattatore cod. 44..029SC <i>AVE USB female connector - input connection through USB male connector - for devices with USB standard - installable on adapter code 44..029SC</i>		9,34	5	5



Sistema 45

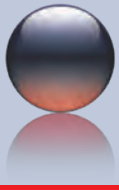

**Procedura d'assemblaggio** *Assembly Procedure*

**Caratteristiche Tecniche** *Technical Features*

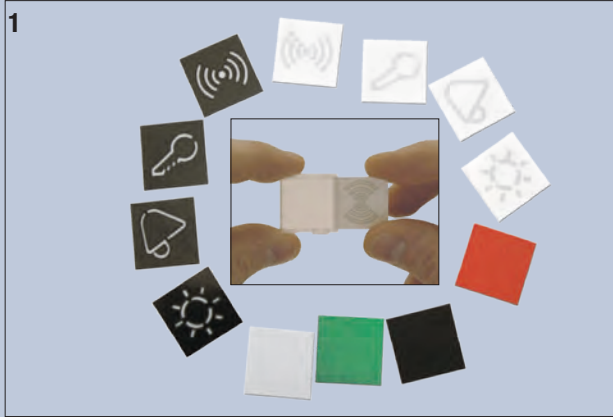

**Scegliere l'etichetta desiderata e introdurla sul retro del diffusore**  
*Select the label and place it in the back of the diffuser*

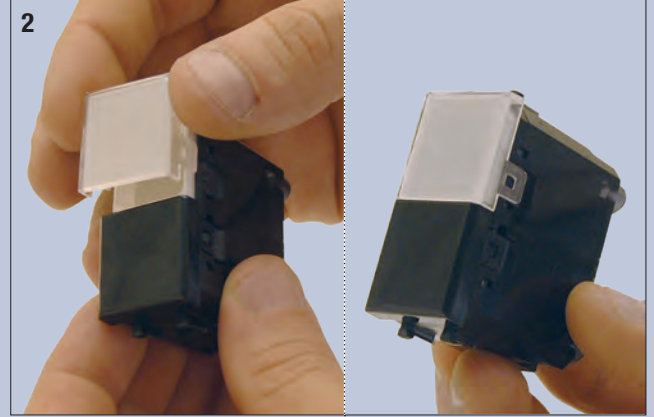

**Applicare il diffusore sulla base nella propria sede**  
*Place the diffuser on its base*

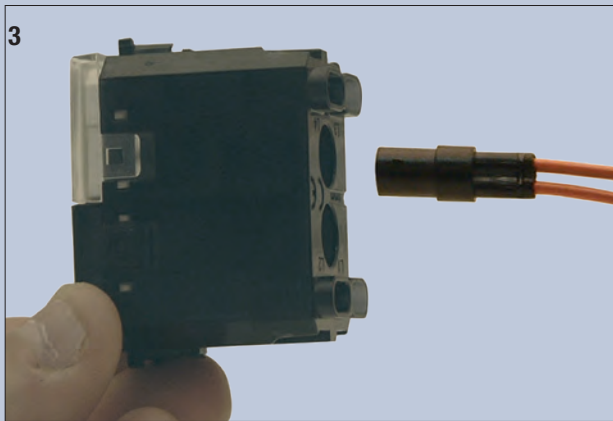

**Introdurre dal retro la lampadina di segnalazione**  
*Introduce the signalling lamp from the back*

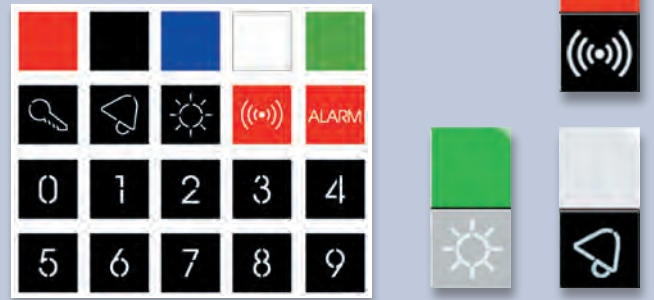

**Prese TV passanti** *Through line TV outlet*



**Presse coassiale**  
*Coaxial socket*



**Derivatore induttivo**  
*Inductive shunt*

**Vista laterale**  
*Side view*

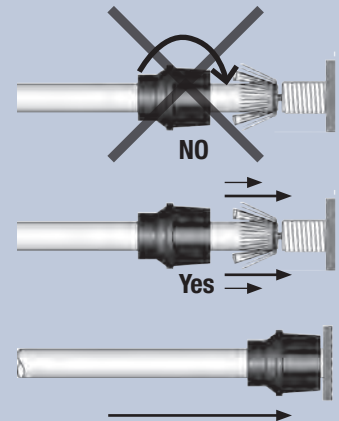
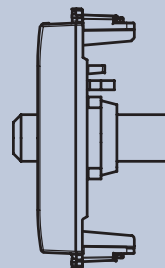

**Inserzione CAP (non avvitando)**  
*Insert CAP (do not screw)*

**ET120 Set da 20 etichette intercambiabili**  
*ET120 Set of 20 interchangeable labels*



Per la disponibilità contattare la rete commerciale  
For availability please contact sales dept.



Disponibilità fino ad esaurimento scorte  
Available until stock out











Prodotto per scatola rettangolare inglese  
Product for British standard rectangular box



Prodotto per Export  
For Export only



## Spie luminose Optical signals

		Descrizione Description	Info	€	□	□
		<b>442037RS</b> Spia di segnalazione con diffusore rosso - fornita con etichette e piastrine intercambiabili - 1 modulo <i>Lampholder with red diffuser - supplied with interchangeable labels and insert lenses - 1 module</i>		12,60	1	10
		<b>442037TR</b> Spia di segnalazione con diffusore trasparente - fornita con etichette e piastrine intercambiabili - 1 modulo <i>Lampholder with transparent diffuser - supplied with interchangeable labels and insert lenses - 1 module</i>		12,60	1	10
		<b>442037VE</b> Spia di segnalazione con diffusore verde - fornita con etichette e piastrine intercambiabili - 1 modulo <i>Lampholder with green diffuser - supplied with interchangeable labels and insert lenses - 1 module</i>		12,60	1	10
		<b>442067</b> Doppia spia di segnalazione con diffusori rosso/verde - fornita con piastrine intercambiabili - 1 modulo <i>Twin lampholder with red/green diffuser - supplied with interchangeable insert lenses - 1 module</i>		13,74	1	10
		<b>442076</b> Spia di segnalazione sporgente (fuoriporta) con diffusore rosso - per lampade con attacco E10 10x28 mm 230V~ 3W max - 2 moduli <i>Prominent lampholder (outside door) with red diffuser - for E10 10x28 mm 230V~ 3W max lamps - 2 modules</i>		19,80	1	6
		<b>442076VE</b> Spia di segnalazione sporgente (fuoriporta) con diffusore verde - per lampade con attacco E10 10x28 mm 230V~ 3W max - 2 moduli <i>Prominent lampholder (outside door) with green diffuser - for E10 10x28 mm 230V~ 3W max lamps - 2 modules</i>		19,80	1	1
		<b>ETI20</b> Set da 20 etichette intercambiabili per spie luminose - scritte e simboli vari <i>Set of 20 interchangeable labels for lampholders - different words and symbols</i>		12,60	1	1

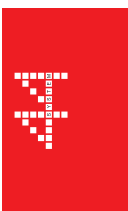

**Nota:** le spie di segnalazione sono fornite senza lampadine di segnalazione  
**Note:** lampholders are supplied without signalling lamp

117



Sistema 45

## Accessori per Impianti Televisivi Accessories for TV systems

		Descrizione Description	Info	€	□	□
		<b>CAP</b> Connettore plastico per cavi coassiali - consente una connessione rapida ed economica - da utilizzare anche con prese 44..096F, 44..096IM, 44..096IF <i>Plastic connector for coaxial cables - it allows a fast and cheap connection - to be used with 44..096F, 44..096IM, 44..096IF sockets</i>		0,60	50	50
		<b>TVSPIM</b> Spina volante TV/SAT schermata per frequenze fino a 2400 MHz - connettore IEC maschio - fornita con n° 1 connettore plastico (CAP) per la connessione <i>Shuttered TV/SAT movable plug for frequencies up to 2400 MHz Male IEC connector - supplied with n.1 plastic connector (CAP)</i>		2,74	50	50

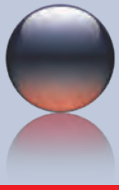

**Installazione lampadine di segnalazione E10** *E10 signalling lamp installation*

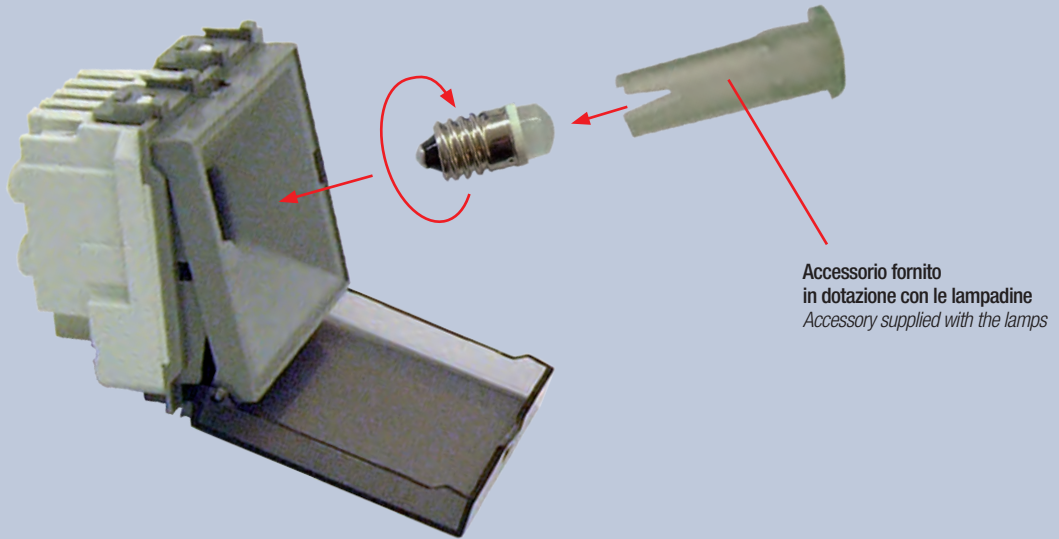

Accessorio fornito  
in dotazione con le lampadine  
*Accessory supplied with the lamps*

**Esempi di utilizzo lampadine di segnalazione** *Signalling lamps application examples*

**Caratteristiche Tecniche** *Technical Features*

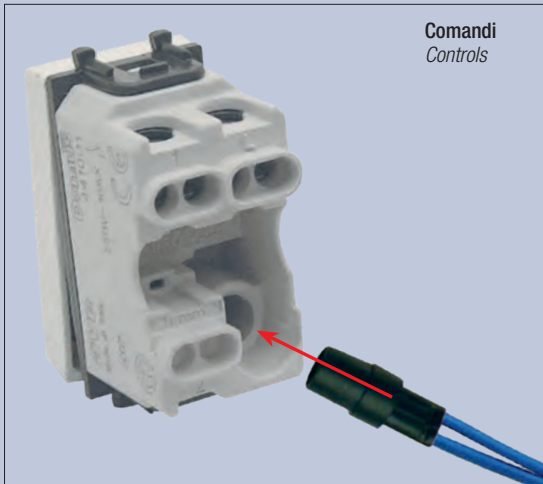

**Comandi**  
*Controls*

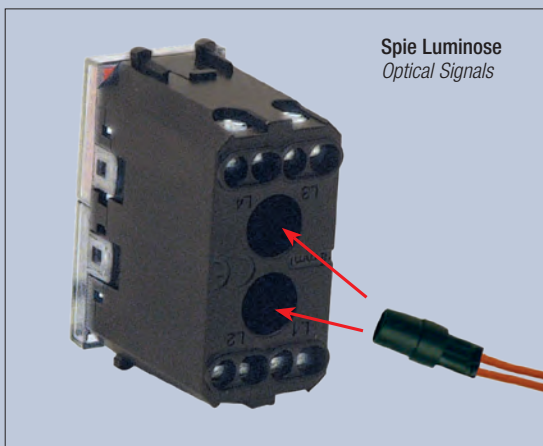

**Spie Luminose**  
*Optical Signals*

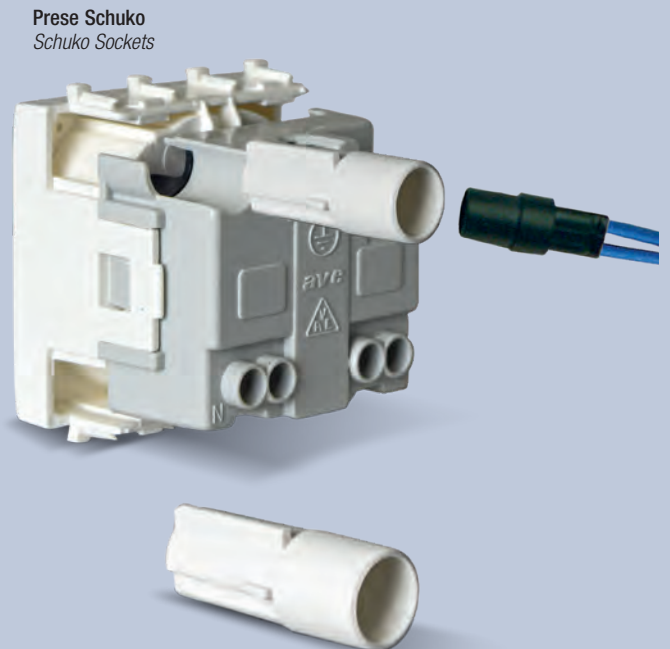

**Prese Schuko**  
*Schuko Sockets*

**Consigliato l'utilizzo di lampada a led colore blu (cod. 0230LDB)**  
*It is recommended the use of blue color led lamp (code 0230LDB)*



Per la disponibilità contattare  
la rete commerciale  
*For availability please contact  
sales dept.*



Disponibilità fino ad  
esaurimento scorte  
*Available until stock out*



Prodotto per scatola  
rettangolare inglese  
*Product for British standard  
rectangular box*



Prodotto  
per Export  
*For Export  
only*

## Lampadine di segnalazione E10

### E10 signalling lamps





	Descrizione <i>Description</i>	Info	€	□	□
 0212LDW/E10 0212LDW/E10HI 0230LDW/E10	<b>0212LDW/E10</b> Lampada a led 12V~ E10 10x22 mm - colore bianco - da utilizzare con pulsanti con targhetta portanome cod. 441005TP/2 e 442005TP/2 <i>Led lamp 12V~ E10 10x22 mm - white colour - to be used with name tag code 441005TP/2 and 442005TP/2</i>		5,32	2	2
	<b>0212LDW/E10HI</b> Lampada a led ad alta intensità 12V~ E10 10x22 mm - colore bianco - da utilizzare con spia di segnalazione sporgente cod. 442076 <i>High intensity led lamp 12V~ E10 10x22 mm - white colour - to be used with prominent lampholder code 442076</i>		5,32	2	2
	<b>0230LDW/E10</b> Lampada a led 230V~ E10 10x22 mm - colore bianco - da utilizzare con pulsanti con targhetta portanome cod.. 441005TP/2 e 442005TP/2 o con spia di segnalazione sporgente cod. 442076 <i>Led lamp 230V~ E10 10x22 mm - white colour - to be used with name tag push buttons code 441005TP/2 and 442005TP/2 or with prominent lampholder code 442076</i>		5,63	2	2

119



Sistema 45

## Lampadine di segnalazione Signalling lamps

	Descrizione <i>Description</i>	Info	€	□	□
 0224	<b>0212LDB</b> Lampada a led 12-24Vcc/ca a basso consumo - colore blu <i>Low consumption 12-24Vac/dc led lamp - blue colour</i>	Consigliata per comandi, prese e spie con simboli <i>It is recommended for controls, sockets and lampholders with symbols</i>	4,22	10	10
	<b>0212LDR</b> Lampada a led 12-24Vcc/ca a basso consumo - colore rosso <i>Low consumption 12-24Vac/dc led lamp - red colour</i>	Consigliata per spie luminose <i>It is recommended for lampholders</i>	4,22	10	10
 0212LDW 0230LDW	<b>0212LDW</b> Lampada a led 12-24Vcc/ca a basso consumo - colore bianco <i>Low consumption 12-24Vac/dc led lamp - white colour</i>	Consigliata per spie luminose rosse <i>It is recommended for red lampholders</i>	4,22	10	10
	<b>0224</b> Lampada ad incandescenza 12/24V~ long life - colore bianco <i>Long life incandescent lamp 12/24Vac - long life - white colour</i>		4,15	10	10
 0212LDR 0230LDR	<b>0230LDB</b> Lampada a led 230V~ a basso consumo - colore blu <i>Low consumption 230V~ led lamp - blue colour</i>	Consigliata per comandi, prese e spie con simboli <i>It is recommended for controls, sockets and lampholders with symbols</i>	4,54	10	10
	<b>0230LDW</b> Lampada a led 230V~ a basso consumo - colore bianco <i>Low consumption 230V~ led lamp - white colour</i>	Consigliata per spie luminose <i>It is recommended for lampholders</i>	4,54	10	10
 0212LDB 0230LDB	<b>0230LDR</b> Lampada a led 230V~ a basso consumo - colore rosso <i>Low consumption 230V~ led lamp - red colour</i>	Consigliata per spie luminose rosse <i>It is recommended for red lampholders</i>	4,54	10	10
	<b>02GL44</b> Accessorio per lampade led di segnalazione - cod.0212 0224 0230 da utilizzare con le prese schuko illuminabili <i>Accessory for led signaling lamps - cod. 0212 0224 0230 to be used with illuminable schuko sockets</i>		0,68	10	10



02GL44

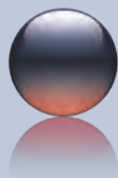

### Nuova gamma DOMUS con trattamento ANTIBATTERICO

Un'ampia gamma di prodotti ANTIBATTERICI basati sulla formulazione dei materiali mescolati a ioduri d'argento. Dedicata a tutte quelle strutture come ospedali, RSA, ambulatori, scuole, mense, bar e in tutti gli altri luoghi dove l'igiene è di fondamentale importanza. Tali additivi sono stati testati secondo le norme ISO 22196:2011 per contrasto ad organismi batterici.

#### Caratteristiche:

- Tasto liscio senza gemma.
- Abbattimento del 99% di proliferazione di batteri.
- Dimmer universale per lampade ad incandescenza e Led.
- Interruttore e pulsante elettronici a sfioramento.

Da completare con le placche antibatteriche versione Domus in Tecnopolimero 44 da 3,4 e 7 moduli.

Altri articoli con il trattamento agli ioni d'argento, possono essere realizzati su richiesta.

Per la pulizia contro virus e batteri è sufficiente l'utilizzo di un detergente neutro.

#### New DOMUS range with ANTIBACTERIAL treatment

A wide range of ANTIBACTERIAL products based on the formulation of materials mixed with silver ions. Dedicated to all those facilities such as hospitals, nursing homes, clinics, schools, canteens, bars and all other places where hygiene is essential. These additives have been tested according to the ISO 22196: 2011 standards to contrast bacterial organisms.

#### Features:

- Smooth rocker without lens
  - 99% reduction of bacteria proliferation.
  - Universal dimmer for incandescent and LED lamps.
  - Electronic touch switch and push button
- Other items with silver ion treatment can be made on request.

The use of a mild detergent is enough for cleaning against viruses and bacteria.



"I dispositivi della gamma antibatterica sono realizzati con la tecnologia Biomaster®. Si tratta di un trattamento agli ioni di argento che è molto efficace contro la formazione e la proliferazione dei batteri sulla superfici dei dispositivi"

"The devices in the antibacterial range are made with Biomaster® technology. It is a silver ion treatment that is very effective against the formation and proliferation of bacteria on the surfaces of the devices "



Per la disponibilità contattare la rete commerciale  
For availability please contact sales dept.















Disponibilità fino ad esaurimento scorte  
Available until stock out



Prodotto per scatola rettangolare inglese  
Product for British standard rectangular box

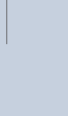
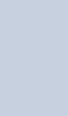

Prodotto per Export  
For Export only

Domus ANTIBATTERICA ANTIBACTERIAL		Descrizione Description	Info	€	□	□
	AB441001	<input type="checkbox"/> <b>AB441001</b> Interruttore 1P 16AX illuminabile - con trattamento antibatterico - 1 modulo <i>1P 16AX one way lightable switch - with antibacterial treatment - 1 module</i>		4,65	10	100
	AB441002	<input type="checkbox"/> <b>AB441010</b> Interruttore 2P 16AX illuminabile - con trattamento antibatterico - 1 modulo <i>2P 16AX one way lightable switch - with antibacterial treatment - 1 module</i>		16,55	10	100
	AB441004	<input type="checkbox"/> <b>AB441002</b> Deviatore 1P 16AX illuminabile - con trattamento antibatterico - 1 modulo <i>1P 16AX two way lightable switch - with antibacterial treatment - 1 module</i>		6,21	10	100
	AB441010	<input type="checkbox"/> <b>AB441004</b> Invertitore 1P 16AX illuminabile - con trattamento antibatterico - 1 modulo <i>1P 16AX lightable intermediate switch - with antibacterial treatment - 1 module</i>		19,61	10	100
	AB441004	<input type="checkbox"/> <b>AB441T</b> Tasto intercambiabile liscio illuminabile - con trattamento antibatterico - 1 modulo <i>Interchangeable smooth lightable rocker - with Antibacterial treatment - 1 module</i>		1,59	14	14
	AB441005	<input type="checkbox"/> <b>AB441T-2</b> Tasto intercambiabile liscio illuminabile - con trattamento antibatterico - 2 moduli <i>Interchangeable smooth lightable rocker - with antibacterial treatment - 2 modules</i>		3,76	2	2
	AB441T	<input type="checkbox"/> <b>AB441005</b> Pulsante 1P NA 10A illuminabile - con trattamento antibatterico - 1 modulo <i>1P NO 10A lightable push-button - with antibacterial treatment - 1 module</i>		6,26	10	100
	AB441T-2	<input type="checkbox"/> <b>AB441017RS</b> Pulsante 1P NA+NC 10A a tirante - con trattamento antibatterico - 1 modulo <i>1P NO+NC 10A cord operated push-button - with antibacterial treatment - 1 module</i>		19,26	1	1
	AB441TGP-2	<input type="checkbox"/> <b>AB441TGP-2</b> Tasto intercambiabile con gemma illuminabile - con trattamento antibatterico - 1 modulo <i>Interchangeable rocker with lightable lens - with antibacterial treatment - 1 module</i>		5,22	2	2
	AB441053	<input type="checkbox"/> <b>AB441TSP</b> Tasto intercambiabile con simbolo SUONERIA illuminabile con trattamento antibatterico - 1 modulo <i>Interchangeable rocker with lightable BELL symbol with antibacterial treatment 1 module</i>		2,63	14	14
	AB441017RS	<input type="checkbox"/> <b>AB441053</b> Commutatore 1P 10A (3 morsetti) a pulsante - 3 posizioni (OFF centrale)- con interblocco: non è consentita la chiusura contemporanea dei 2 circuiti - 2 tasti - con frecce direzionali con trattamento antibatterico - 1 modulo <i>1P 10A rolling blind push-button (3 terminals) - 3 positions (central OFF) - with interlock: the simultaneous closure of the 2 circuits is not allowed - 2 rockers - with arrows with antibacterial treatment - 1 module</i>		23,41	1	10
	AB441001S	<input type="checkbox"/> <b>AB441001S</b> Interruttore elettronico con uscita a relè 1P NA 6A 230V~ - comando mediante sfioro superficie frontale o da più punti con normali pulsanti NA - funzionamento bistabile - led di individuazione al buio a basso consumo - memorizzazione dello stato del relè d'uscita in caso di interruzione di rete - alimentazione 230V~ con trattamento antibatterico - 1 modulo <i>Electronic touch switch - relay output 1P NO 6A 230V~ - controlled by touching the frontal area or from multiple points with NO push buttons - bistable operating mode - low consumption led for identification in the dark - output relay status memorization in case of black out - 230V~ power supply with antibacterial treatment - 1 module</i>		87,66	1	10
	AB441005S	<input type="checkbox"/> <b>AB441005S</b> Pulsante elettronico per comando remoto con sensore a sfioramento - comando mediante sfioro superficie frontale - funzionamento monostabile - led di individuazione al buio a basso consumo - alimentazione 230V~ - con trattamento antibatterico - 1 modulo <i>Electronic push button for remote control with touch sensor - controlled by touching the frontal area - monostable operating mode - low consumption led for identification in the dark - 230V~ power supply - with antibacterial treatment - 1 module</i>		83,59	1	10
	AB441008	<input type="checkbox"/> <b>AB441008</b> Uscita Ø 9 mm con serracavo antitrazione - con trattamento antibatterico - 1 modulo <i>able outlet Ø 9 mm with cable grip - with antibacterial treatment - 1 module</i>		3,77	10	100
	AB441013	<input type="checkbox"/> <b>AB441013</b> Tappo copriforo - con trattamento antibatterico - 1 modulo <i>Blank insert - with antibacterial treatment - 1 module</i>		1,40	10	300

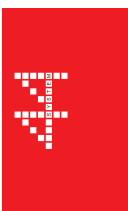

Sistema 45



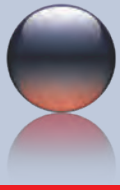

# Serie Domus - ANTIBATTERICA

Domus - Antibacterial

## Caratteristiche Tecniche Technical Features



Per la disponibilità contattare la rete commerciale  
For availability please contact sales dept.



Disponibilità fino ad esaurimento scorte  
Available until stock out



Prodotto per scatola rettangolare inglese  
Product for British standard rectangular box



Prodotto per Export  
For Export only

Prese di corrente 250V~  
250V~ socket outlets

Domus ANTIBATTERICA ANTIBACTERIAL		Descrizione Description	Info	€	□	□
	AB441006-15TS	<b>□ AB441006-15TS</b> Presa bipasso P17/11 2P+T 10/16A - alveoli schermati con trattamento antibatterico - 1 modulo <i>Combined P17/11 Italian standard socket 2P+E 10/16A with antibacterial treatment - 1 module</i>		8,06	10	100
	AB441090-15TS	<b>□ AB441090-15TS</b> Presa schuko bipasso P40 (UNIVERSALE) 2P+T 10/16A con trattamento antibatterico - 2 moduli <i>2P+E 10/16A (UNIVERSAL) combined Schuko + Italian standard socket with antibacterial treatment - 2 modules</i>		13,96	5	50
	AB441090TS	<b>□ AB441090TS</b> Presa schuko P30 2P+T 16A - alveoli schermati con trattamento antibatterico - 2 moduli <i>P30 2P+E 16A Schuko socket - shuttered - with antibacterial treatment - 2 modules</i>		14,06	5	50
	AB442006-15TSR	<b>■ AB442006-15TSR</b> Presa bipasso P17/11 2P+T 10/16A - alveoli schermati con trattamento antibatterico - 1 modulo <i>Combined P17/11 Italian standard socket 2P+E 10/16A with antibacterial treatment - 1 module</i>		10,96	10	100
	AB442090TSR	<b>■ AB442090TSR</b> Presa schuko P30 2P+T 16A - alveoli schermati con trattamento antibatterico - 2 moduli <i>P30 2P+E 16A Schuko socket - shuttered - with antibacterial treatment - 2 modules</i>		16,17	5	50
	AB442090-15TSR	<b>■ AB442090-15TSR</b> Presa schuko bipasso P40 (UNIVERSALE) 2P+T 10/16A - alveoli schermati con trattamento antibatterico - 2 moduli <i>2P+E 10/16A (UNIVERSAL) Schuko + Italian standard socket with antibacterial treatment - 2 modules</i>		19,60	5	50

123

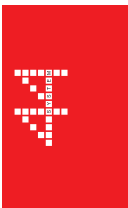

Sistema 45

Prese telefoniche Telephone socket outlets

Domus ANTIBATTERICA ANTIBACTERIAL		Descrizione Description	Info	€	□	□
	AB441024	<b>□ AB441024</b> Presa telefonica RJ11 (6 poli / 4 contatti) - con trattamento antibatterico - 1 modulo <i>RJ11 telephone socket (6 poles / 4 contacts) - with antibacterial treatment - 1 module</i>		23,04	1	12
	AB441029C6	<b>□ AB441029C6</b> Presa RJ45 categoria 6 - non schermata - connettore 3M - morsetti ad incisione d'isolante con cablaggio rapido - cablaggio universale T568A e T568B - 8 contatti - sportellino antipolvere integrato nel connettore - con trattamento antibatterico 1 modulo <i>RJ45 category 6 outlet - not shuttered - 3M connector - insulation piercing terminals with rapid wiring - T568A and T568B universal wiring - 8 contacts - anti-dust lid integrated in the connector - with antibacterial treatment - 1 module</i>		31,71	1	10
	AB441029C6S	<b>□ AB441029C6S</b> Presa RJ45 categoria 6 - schermata - connettore 3M - morsetti ad incisione d'isolante con cablaggio rapido - cablaggio universale T568A e T568B - 8 contatti sportellino antipolvere integrato nel connettore - con trattamento antibatterico 1 modulo <i>RJ45 category 6 outlet - shuttered - 3M connector - insulation piercing terminals with rapid wiring - T568A and T568B universal wiring - 8 contacts - anti-dust lid integrated in the connector - with antibacterial treatment - 1 module</i>		40,64	1	10
	AB441029SC	<b>□ AB441029SC</b> Adattatore per connettori RJ45 - con trattamento antibatterico -1 modulo <i>Adaptor for RJ45 - with antibacterial treatment - 1 module</i>		7,42	4	4
	AB441096IM	<b>□ AB441096IM</b> Presa coassiale TV/SAT diretta - con trattamento antibatterico -1 modulo <i>TV/SAT direct coaxial socket - with antibacterial treatment - 1 module</i>		14,49	1	12
	AB441096F	<b>□ AB441096F</b> Presa coassiale TV/SAT diretta - con trattamento antibatterico -1 modulo <i>TV/SAT direct coaxial socket - with antibacterial treatment - 1 module</i>		15,14	1	12

Le dimensioni, salvo diversamente specificato, sono in mm  
Dimensions, except where otherwise specified, are in mm

Imballo Minimo pcs  
Min. Packaging pcs

Imballo Standard pcs  
Std. Packaging pcs

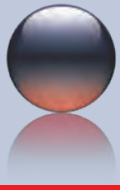

# Serie Domus - ANTIBATTERICA

Domus - Antibacterial

## Caratteristiche Tecniche Technical Features

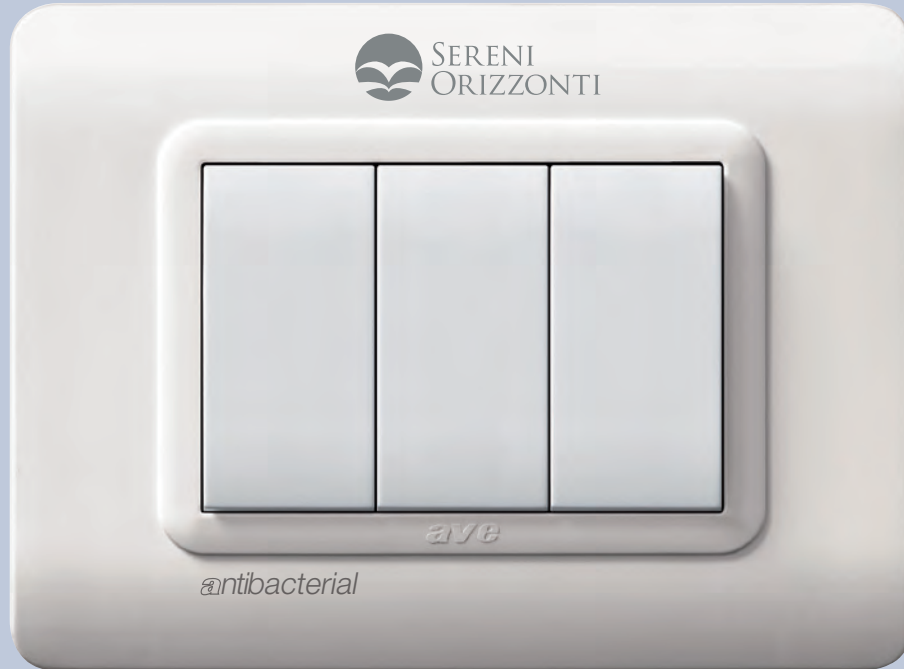

Per la disponibilità contattare la rete commerciale  
For availability please contact sales dept.



Disponibilità fino ad esaurimento scorte  
Available until stock out



Prodotto per scatola rettangolare inglese  
Product for British standard rectangular box





Prodotto per Export  
For Export only



**Dimmer per regolazione luci**  
Dimmer for lighting controls

**Portafusibili 250V~ Fuse Holders 250V~**

Domus ANTIBATTERICA ANTIBACTERIAL	Descrizione Description	Info	€	□	□
 AB441007	<p><b>□ AB441007</b> Portafusibile per fusibili in miniatura 1P 10A - per fusibili Ø 5x20 mm con trattamento antibatterico - 1 modulo <i>Fuse holder for miniature fuses 1P 10A - for fuses Ø 5x20 mm - with antibacterial treatment - 1 module</i></p>		15,82	1	10
 AB441048UL	<p><b>□ AB441048UL</b> Regolatore di luminosità 230V~ 50-60 Hz per carichi resistivi e induttivi (lampade ad incandescenza e alogene 3-220W, trasformatori elettronici 20-220W, lampade LED 3-120W, lampade CFL 3-220W - alimentatori elettronici LED a taglio di fase) - comando e regolazione con pulsante incorporato o da più punti con normali pulsanti NA - led di individuazione al buio a basso consumo - memorizzazione dello stato e del livello dell'uscita in caso d'interruzione di rete - con trattamento antibatterico 1 modulo <i>230V~ 50-60 Hz dimmer for resistive and inductive loads (3-220W incandescent and halogen lamps, ferromagnetic transformers 20-220W, LED lamps 3-120W, CFL lamps 3-220W - electronic ballasts for LED with line interruption) - control and regulation by built-in push-button or by normal NO push-button from more points - low consumption led for identification in the dark - status and level memory in case of blackout - with antibacterial treatment - 1 module</i></p>		104,95	1	6

125

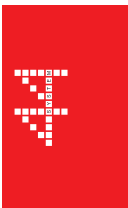

Sistema 45

**Placche in plastica "Tecnopolimero 44" per scatola rettangolare**  
"44 moulded" front plates for rectangular box

Domus ANTIBATTERICA ANTIBACTERIAL	Descrizione Description	Info	€	□	□
 AB44PY03B	<p><b>AB44PY03B</b> Placca in tecnopolimero 44 - 3 moduli Bianco Ral 9010 - con trattamento antibatterico <i>44 moulded front plates - 3 modules Ral 9010 white - with antibacterial treatment</i></p>		3,47	1	25
 AB44PY04B	<p><b>AB44PY04B</b> Placca in tecnopolimero 44 - 4 moduli Bianco Ral 9010 - con trattamento antibatterico <i>44 moulded front plates - 4 modules Ral 9010 white - with antibacterial treatment</i></p>		6,93	1	20
 AB44PY07B	<p><b>AB44PY07B</b> Placca in tecnopolimero 44 - 7 moduli Bianco Ral 9010 - con trattamento antibatterico <i>44 moulded front plates - 7 modules Ral 9010 white - with antibacterial treatment</i></p>		11,01	1	15

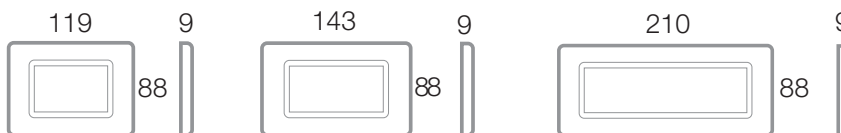

Supporti da utilizzare  
To be used with



44A03



44A04



44A07

Le dimensioni, salvo diversamente specificato, sono in mm  
Dimensions, except where otherwise specified, are in mm

□ Imballo Minimo pcs  
Min. Packaging pcs

□ Imballo Standard pcs  
Std. Packaging pcs