

# Placche delle Serie Civili

## Sistema 45

### System 45

Wiring Accessories front plates



**Design:**

A. Van Onck  
M. Hasuike  
H.M.R.  
B. Dall'Eco  
L. Merletti

**Indice**  
**Index**

Placche  
Banquise 45  
Banquise 45 front plates

**336**



Placche  
Zama 45  
Zama 45 front plates

**338**



Placche  
RAL 45  
RAL 45 front plates

**341**



Placche  
Yes 45  
Yes 45 front plates

**345**



Placche  
Blanc 45  
Blanc 45 front plates

**349**

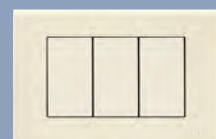



# Placche

## Front Plates

# Sistema 45

Placche in metallo "Banquise" con inserto illuminabile per scatola rettangolare  
 "Banquise" metal front plates with lightable insert for rectangular boxes

Design:  
M. Hasuike

336

3 MODULI / 3 MODULES



Cod. Code	Descrizione Description	Info	€	□	□
45PB93BMC	Bianco Banquise micalizzato Mica-finished Banquise white	22,10	1	15	
45PB93GSM	Grigio scuro metallizzato Metallic dark grey	22,10	1	15	
45PB93NCS	Nichel spazzolato Brushed nickel	33,62	1	15	
45PB93OT	Ottone lucido Polished brass	33,62	1	15	

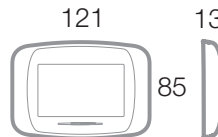

Supporto da utilizzare  
To be used with



45B63

4 MODULI / 4 MODULES



Cod. Code	Descrizione Description	Info	€	□	□
45PB94BMC	Bianco Banquise micalizzato Mica-finished Banquise white	30,03	1	14	
45PB94GSM	Grigio scuro metallizzato Metallic dark grey	30,03	1	14	
45PB94OT	Ottone lucido Polished brass	43,76	1	14	

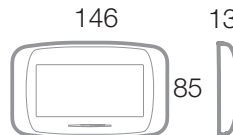

Supporto da utilizzare  
To be used with



45764

6 MODULI / 6 MODULES



Cod. Code	Descrizione Description	Info	€	□	□
45PB96BMC	Bianco Banquise micalizzato Mica-finished Banquise white	38,44	1	10	

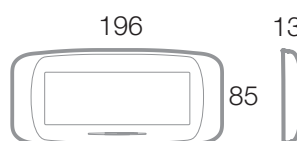

Supporto da utilizzare  
To be used with



45366



Per la disponibilità contattare la rete commerciale  
For availability please contact sales dept.



Disponibilità fino ad esaurimento scorte  
Available until stock out



Prodotto 2 moduli adatto anche per scatola tonda  
2 modules product suitable for round box



Prodotto per scatola rettangolare inglese  
Product for British standard rectangular box



Prodotto per Export  
For Export only

## Placche in tecnopolimero "Banquise" per scatola rettangolare "Banquise" moulded front plates for rectangular boxes

Design:  
M. Hasuike

3 MODULI / 3 MODULES		Cod. Code	Descrizione Description	Info	€	□	□
	45PB03BB	Bianco Banquise (RAL 9016) Banquise white (RAL 9016)	5,38	1	25		
	45PB03BP	Bianco Blanc (RAL 1013) Blanc white (RAL 1013)	5,38	1	25		
	45PB03GSM	Grigio scuro metallizzato Metallic dark grey	10,00	1	25		
	45PB03NL	Nero lucido Polished black	5,38	1	25		

45PB03BB

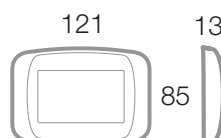

Supporto da utilizzare  
To be used with



45B63

## Placche in tecnopolimero "Banquise" per scatola rettangolare "Banquise" moulded front plates for rectangular boxes

4 MODULI / 4 MODULES		Cod. Code	Descrizione Description	Info	€	□	□
	45PB04BB	Bianco Banquise (RAL 9016) Banquise white (RAL 9016)	7,94	1	20		
	45PB04BP	Bianco Blanc (RAL 1013) Blanc white (RAL 1013)	7,94	1	20		
	45PB04GSM	Grigio scuro metallizzato Metallic dark grey	14,03	1	20		
	45PB04NL	Nero lucido Polished black	7,94	1	20		

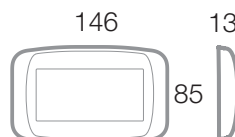

Supporto da utilizzare  
To be used with



45764

## Placche in tecnopolimero "Banquise" per scatola rettangolare "Banquise" moulded front plates for rectangular boxes

6 MODULI / 6 MODULES		Cod. Code	Descrizione Description	Info	€	□	□
	45PB06BB	Bianco Banquise (RAL 9016) Banquise white (RAL 9016)	11,76	1	15		
	45PB06GSM	Grigio scuro metallizzato Metallic dark grey	16,48	1	15		
	45PB06NL	Nero lucido Polished black	11,76	1	15		

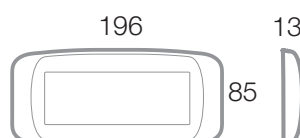

Supporto da utilizzare  
To be used with



45366

Le dimensioni, salvo diversamente specificato, sono in mm  
Dimensions, except where otherwise specified, are in mm

◇ Prodotto per scatola quadrata  
Product for British Standard  
square box only

② Prodotto 1 modulo installabile in scatola tonda  
con altro prodotto 1 modulo  
1 module product installable in round box with  
another 1 module device

□ Imballo Minimo pcs  
Min. Packaging pcs

□ Imballo Standard pcs  
Std. Packaging pcs



Sistema 45



# Placche Front Plates

## Sistema 45

### Placche in metallo "Zama 45" per scatola rettangolare "Zama 45" metal front plates for rectangular boxes

Design:  
M. Hasuike

338

3 MODULI / 3 MODULES



45P93AM



45P93BG



45P93BP



45P93CR



45P93GSM



45P93BMC



45P93NL

Cod. Code	Descrizione Description	Info	€	□	□
45P93AM	Argento metallizzato Metallic silver		20,80	1	15
45P93BG	Bianco Banquise (RAL 9016) Banquise white (RAL 9016)		20,32	1	15
45P93BMC	Bianco Banquise micalizzato Mica-finished Banquise white		20,80	1	15
45P93BP	Bianco Blanc (RAL 1013) Blanc white (RAL 1013)		20,32	1	15
45P93CR	Cromo Chrome		31,48	1	15
45P93GSM	Grigio scuro metallizzato Metallic dark grey		20,80	1	15
45P93NL	Nero lucido Polished black		20,80	1	15

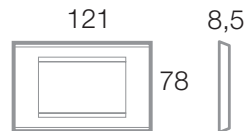

Supporto da utilizzare  
To be used with



45B63

### Placche in metallo "Zama 45" per scatola rettangolare "Zama 45" metal front plates for rectangular boxes

4 MODULI / 4 MODULES



Cod. Code	Descrizione Description	Info	€	□	□
45P94AM	Argento metallizzato Metallic silver		30,06	1	14
45P94BG	Bianco Banquise (RAL 9016) Banquise white (RAL 9016)		28,56	1	14
45P94BP	Bianco Blanc (RAL 1013) Blanc white (RAL 1013)		30,06	1	14
45P94CR	Cromo Chrome		39,89	1	14
45P94GSM	Grigio scuro metallizzato Metallic dark grey		30,06	1	14

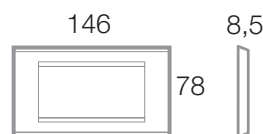

Supporto da utilizzare  
To be used with



45764



Per la disponibilità contattare  
la rete commerciale  
For availability please contact  
sales dept.



Disponibilità fino ad  
esaurimento scorte  
Available until stock out



Prodotto 2 moduli adatto  
anche per scatola tonda  
2 modules product suitable  
for round box



Prodotto per scatola  
rettangolare inglese  
Product for British standard  
rectangular box



Prodotto  
per Export  
For Export  
only

## Placche in metallo "Zama 45" per scatola rettangolare

"Zama 45" metal front plates for rectangular boxes

Design:  
M. Hasuike

6 MODULI / 6 MODULES	Cod. Code	Descrizione Description	Info	€	□	□
	45P96BG	Bianco Banquise (RAL 9016) Banquise white (RAL 9016)	40,20	1	10	
	45P96CR	Cromo Chrome	53,81	1	10	
	45P96GSM	Grigio scuro metallizzato Metallic dark grey	40,20	1	10	
	45P96TT	Ottone lucido Polished brass	54,26	1	10	

339



Sistema 45

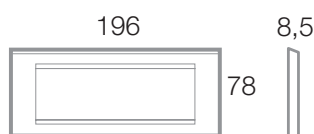

### Supporto da utilizzare

To be used with



45366

### Placche "antisalinità"

L'installazione in ambienti soggetti all'influenza del mare (ad esempio le imbarcazioni) o con presenza di soluzioni saline, può provocare, alle normali placche, un precoce deterioramento della verniciatura. Per ovviare a questo problema Ave ha inserito le "placche antisalinità" che, grazie ad un rivoluzionario processo di verniciatura, garantiscono una maggior resistenza nel tempo alla finitura originale. Ave offre la possibilità di avere questo trattamento solo sulle seguenti 5 colorazioni: bianco Banquise (BG), bianco Blanc (BP), cromo (CR), ottone (TT), radica (RD). Modalità di ordinazione: indicare nell'ordine, dopo il codice della placca desiderata, "con trattamento antisalinità".

### Anti-salinity front plates

The installation in environments close to the sea (for example the boats) or where salt solutions are present, can cause a premature deterioration of the paint in normal kind of front plates. In order to solve this problem, Ave proposes the anti-salinity front plates: thanks to a revolutionary process of paint, they guarantee a greater resistance through the time. Ave can offer this special paint in the following colours: Banquise white (BG), Blanc white (BP), Chrome (CR), Brass (TT), Briarwood (RD). How to order them: indicate on your purchase order "with anti-salinity treatment" after the front plate code.



Le dimensioni, salvo diversamente specificato, sono in mm  
Dimensions, except where otherwise specified, are in mm

◆ Prodotto per scatola quadrata  
Product for British Standard  
square box only

② Prodotto 1 modulo installabile in scatola tonda  
con altro prodotto 1 modulo  
1 module product installable in round box with  
another 1 module device

□ Imballo Minimo pcs  
Min. Packaging pcs

□ Imballo Standard pcs  
Std. Packaging pcs



**Placche in metallo "antivandalo" per scatole rettangolari**  
"Anti-vandal" metal front plates for rectangular boxes

Design:  
M. Hasuike

340



45P93TIAV



45P94TIAV

Cod. Code	Descrizione Description	Info	€	□	□
45P93TIAV	Placca "antivandalo" 3 moduli - fissaggio al supporto con viti speciali che non permettono il distacco della placca se non con l'utilizzo di un apposito attrezzo - fornita con supporto speciale - colore titanio "Anti-vandal" front plate 3 modules - particular fixing system to the frame with special screws that do not allow to remove the plate except by an appropriate tool - provided with special frame - brushed nickel colour		39,59	1	1
45P94TIAV	Placca "antivandalo" 4 moduli - fissaggio al supporto con viti speciali che non permettono il distacco della placca se non con l'utilizzo di un apposito attrezzo - fornita con supporto speciale - colore titanio "Anti-vandal" front plate 4 modules - particular fixing system to the frame with special screws that do not allow to remove the plate except by an appropriate tool - provided with special frame - titanium colour		40,54	1	1

**Nota:** fornite con supporto speciale

**Note:** supplied with special frame

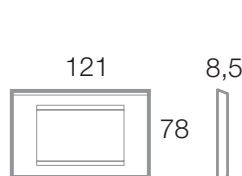

Supporto da utilizzare  
To be used with



45B63

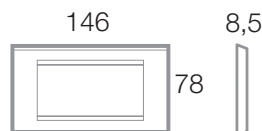

Supporto da utilizzare  
To be used with



45764

**Sequenza installativa** Installation

Scatola da incasso 2503MG  
2503MG flush mounted box

Fori per fissaggio a pannello  
Fixing holes for panel mounting

Placca antivandalo  
"Anti-vandal" front plate

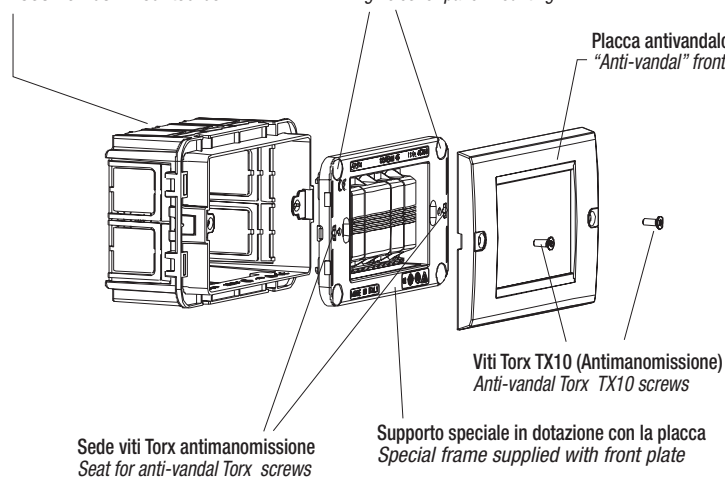

N.B. Chiave a Torx non in dotazione  
N.B. Torx key not supplied

**Accessori** Accessories



25GS

**25GS**  
Ganci metallici di ricambio per scatole porta frutti 3 e 4 moduli  
Spare metallic hooks for 3 and 4 modules boxes

Info € □ □

5,61 2 2



Per la disponibilità contattare la rete commerciale  
For availability please contact sales dept.



Disponibilità fino ad esaurimento scorte  
Available until stock out



Prodotto 2 moduli adatto anche per scatola tonda  
2 modules product suitable for round box



Prodotto per scatola rettangolare inglese  
Product for British standard rectangular box



Prodotto per Export  
For Export only



## Placche in tecnopolimero "Ral 45" sabbiate "Ral 45" matt finish moulded front plates

Design:  
H. M. R.

341

1 MODULO / 1 MODULE



Cod. Code	Descrizione Description	Info	€	□	□
45P01BP	Bianco Blanc (RAL 1013) Blanc white (RAL 1013)		3,24	1	25
45P01GN	Grigio Noir Noir grey		3,24	1	25

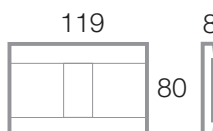

Supporto da utilizzare  
To be used with



45B63

2 Moduli 2 Modules



Cod. Code	Descrizione Description	Info	€	□	□
45P02GN	Grigio Noir Noir grey		3,17	1	25

**Nota:** con il supporto 45B63 sono installabili centralmente solo i prodotti del Sistema 45 contrassegnati, nella colonna "Info", con i simboli • e ②  
**Note:** with the 45B63 frame, only system 45 products with the symbols • and ② in the "info" column can be installed centrally

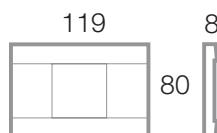

Supporti da utilizzare  
To be used with



45762



45B63

2 (1+1) Moduli 2 (1+1) Modules



Cod. Code	Descrizione Description	Info	€	□	□
45P002BP	Bianco Blanc (RAL 1013) Blanc white (RAL 1013)		3,17	1	25
45P002GN	Grigio Noir Noir grey		3,17	1	25
45P002R	Grigio RAL 7035 7035 RAL grey		3,17	1	25

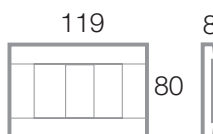

Supporto da utilizzare  
To be used with



45B63

Le dimensioni, salvo diversamente specificato, sono in mm  
Dimensions, except where otherwise specified, are in mm

◆ Prodotto per scatola quadrata  
Product for British Standard  
square box only

② Prodotto 1 modulo installabile in scatola tonda  
con altro prodotto 1 modulo  
1 module product installable in round box with  
another 1 module device

□ Imballo Minimo pcs  
Min. Packaging pcs

□ Imballo Standard pcs  
Std. Packaging pcs





3 Moduli 3 Modules

Design:  
H. M. R.

342



45P03R

Cod. Code	Descrizione Description	Info	€	□	□
45P03BP	Bianco Blanc (RAL 1013) <i>Blanc white (RAL 1013)</i>	3,45	1	25	
45P03GN	Grigio Noir <i>Noir grey</i>	3,45	1	25	
45P03R	Grigio RAL 7035 <i>7035 RAL grey</i>	3,45	1	25	



45P03GN



45P03BP

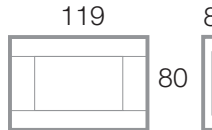

Supporto da utilizzare  
*To be used with*



45B63

4 Moduli 4 Modules



Cod. Code	Descrizione Description	Info	€	□	□
45P04BP	Bianco Blanc (RAL 1013) <i>Blanc white (RAL 1013)</i>	6,67	1	20	
45P04GN	Grigio Noir <i>Noir grey</i>	6,62	1	20	
45P04R	Grigio RAL 7035 <i>7035 RAL grey</i>	6,62	1	20	

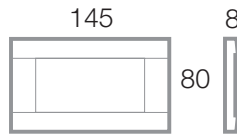

Supporto da utilizzare  
*To be used with*



45764

6 Moduli 6 Modules



Cod. Code	Descrizione Description	Info	€	□	□
45P06BP	Bianco Blanc (RAL 1013) <i>Blanc white (RAL 1013)</i>	11,16	1	15	
45P06GN	Grigio Noir <i>Noir grey</i>	11,16	1	15	

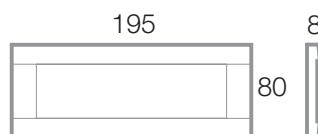

Supporto da utilizzare  
*To be used with*



45366



Per la disponibilità contattare  
la rete commerciale  
For availability please contact  
sales dept.



Disponibilità fino ad  
esaurimento scorte  
Available until stock out



Prodotto 2 moduli adatto  
anche per scatola tonda  
2 modules product suitable  
for round box



Prodotto per scatola  
rettangolare inglese  
Product for British standard  
rectangular box



Prodotto  
per Export  
For Export  
only

## Placche in tecnopolimero "Ral 45" lucide "Ral 45" glossy finish moulded front plates

Design:  
M. Hasuike

343

1 MODULO / 1 MODULE



Cod. Code	Descrizione Description	Info	€	□	□
45P01BG	Bianco Banquise (RAL 9016) Banquise white (RAL 9016)		3,24	1	25

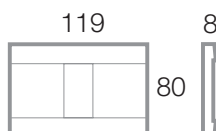

Supporto da utilizzare  
To be used with



45B63

2 Moduli 2 Modules



Cod. Code	Descrizione Description	Info	€	□	□
45P02BG	Bianco Banquise (RAL 9016) Banquise white (RAL 9016)		3,17	1	25

**Nota:** con il supporto 45B63 sono installabili centralmente solo i prodotti del Sistema 45 contrassegnati, nella colonna "Info", con i simboli • e ②  
**Note:** with the 45B63 frame, only system 45 products with the symbols • and ② in the "info" column can be installed centrally

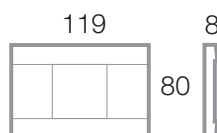

Supporti da utilizzare  
To be used with



45762



45B63

2 (1+1) Moduli 2 (1+1) Modules



Cod. Code	Descrizione Description	Info	€	□	□
45P002BG	Bianco Banquise (RAL 9016) Banquise white (RAL 9016)		3,17	1	25

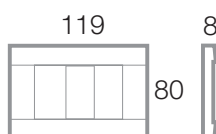

Supporto da utilizzare  
To be used with



45B63

Le dimensioni, salvo diversamente specificato, sono in mm  
Dimensions, except where otherwise specified, are in mm

◇ Prodotto per scatola quadrata  
Product for British Standard  
square box only

② Prodotto 1 modulo installabile in scatola tonda  
con altro prodotto 1 modulo  
1 module product installable in round box with  
another 1 module device

□ Imballo Minimo pcs  
Min. Packaging pcs

□ Imballo Standard pcs  
Std. Packaging pcs



3 Moduli 3 Modules

Design:  
M. Hasuike

344



45P03BG

Cod. Code	Descrizione Description	Info	€	□	□
45P03BG	Bianco Banquise (RAL 9016) Banquise white (RAL 9016)		3,45	1	25
45P03NL	Nero lucido Polished black		3,45	1	25



45P03NL

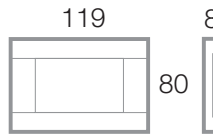

Supporto da utilizzare  
To be used with



45B63

4 Moduli 4 Modules

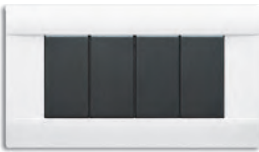

Cod. Code	Descrizione Description	Info	€	□	□
45P04BG	Bianco Banquise (RAL 9016) Banquise white (RAL 9016)		6,62	1	20

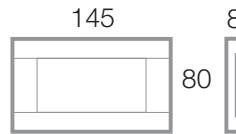

Supporto da utilizzare  
To be used with



45764

6 Moduli 6 Modules

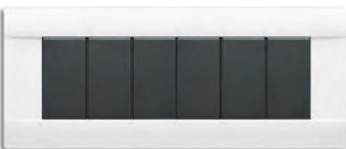

Cod. Code	Descrizione Description	Info	€	□	□
45P06BG	Bianco Banquise (RAL 9016) Banquise white (RAL 9016)		11,16	1	15

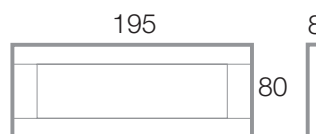

Supporto da utilizzare  
To be used with



45366



Per la disponibilità contattare  
la rete commerciale  
For availability please contact  
sales dept.



Disponibilità fino ad  
esaurimento scorte  
Available until stock out



Prodotto 2 moduli adatto  
anche per scatola tonda  
2 modules product suitable  
for round box



Prodotto per scatola  
rettangolare inglese  
Product for British standard  
rectangular box



Prodotto  
per Export  
For Export  
only

## Placche in tecnopolimero "Yes 45" per scatola rettangolare

"Yes 45" series moulded front plates - rectangular box

Design:  
H. M. R.

### 1 MODULO / 1 MODULE



Cod. Code	Descrizione Description	Info	€	□	□
45PY01BB	Bianco Banquise (RAL 9016) <i>Banquise white (RAL 9016)</i>	3,03	1	25	
45PY01BP	Bianco Blanc (RAL 1013) <i>Blanc white (RAL 1013)</i>	3,05	1	25	
45PY01GN	Grigio Noir <i>Noir grey</i>	3,05	1	25	

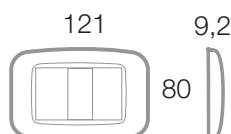

Supporto da utilizzare  
To be used with



45B63



Sistema 45

### 2 (1+1) Moduli 2 (1+1) Modules



Cod. Code	Descrizione Description	Info	€	□	□
45PY002BB	Bianco Banquise (RAL 9016) <i>Banquise white (RAL 9016)</i>	3,03	1	25	
45PY002BP	Bianco Blanc (RAL 1013) <i>Blanc white (RAL 1013)</i>	3,05	1	25	
45PY002GN	Grigio Noir <i>Noir grey</i>	3,05	1	25	

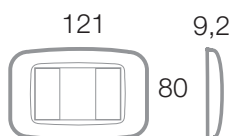

Supporto da utilizzare  
To be used with



45B63

### 2 Moduli 2 Modules



Cod. Code	Descrizione Description	Info	€	□	□
45PY02BB	Bianco Banquise (RAL 9016) <i>Banquise white (RAL 9016)</i>	3,05	1	25	
45PY02BP	Bianco Blanc (RAL 1013) <i>Blanc white (RAL 1013)</i>	3,05	1	25	
45PY02GN	Grigio Noir <i>Noir grey</i>	3,05	1	25	

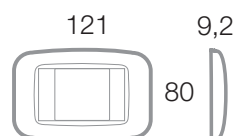

Supporto da utilizzare  
To be used with



45762



45B63

Le dimensioni, salvo diversamente specificato, sono in mm  
Dimensions, except where otherwise specified, are in mm

◆ Prodotto per scatola quadrata  
Product for British Standard  
square box only

② Prodotto 1 modulo installabile in scatola tonda  
con altro prodotto 1 modulo  
1 module product installable in round box with  
another 1 module device

□ Imballo Minimo pcs  
Min. Packaging pcs

□ Imballo Standard pcs  
Std. Packaging pcs



3 Moduli 3 Modules

Design:  
H. M. R.

346



Cod. Code	Descrizione Description	Info	€	□	□
45PY03AO	Argento opaco Matt silver	10,53	1	25	
45PY03BB	Bianco Banquise (RAL 9016) Banquise white (RAL 9016)	2,94	1	25	
45PY03BP	Bianco Blanc (RAL 1013) Blanc white (RAL 1013)	3,05	1	25	
45PY03CHO	Champagne opaco Champagne	10,53	1	25	
45PY03GN	Grigio Noir Noir grey	3,05	1	25	
45PY03GSM	Grigio scuro metallizzato Metallic dark grey	10,53	1	25	

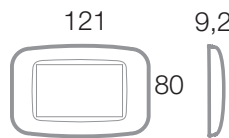

Supporto da utilizzare  
To be used with



45B63

Design:  
H. M. R.

Placche in tecnopolimero "Yes 45" per scatola rettangolare  
"Yes 45" series moulded front plates - rectangular box

4 MODULI / 4 MODULES



Cod. Code	Descrizione Description	Info	€	□	□
45PY04AO	Argento opaco Matt silver	14,90	1	20	
45PY04BB	Bianco Banquise (RAL 9016) Banquise white (RAL 9016)	6,11	1	20	
45PY04BP	Bianco Blanc (RAL 1013) Blanc white (RAL 1013)	6,28	1	20	
45PY04GN	Grigio Noir Noir grey	6,28	1	20	
45PY04GSM	Grigio scuro metallizzato Metallic dark grey	14,90	1	20	

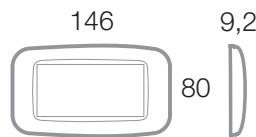

Supporto da utilizzare  
To be used with



45764

6 Moduli 6 Modules



Cod. Code	Descrizione Description	Info	€	□	□
45PY06AO	Argento opaco Matt silver	17,34	1	15	
45PY06BB	Bianco Banquise (RAL 9016) Banquise white (RAL 9016)	9,87	1	15	
45PY06BP	Bianco Blanc (RAL 1013) Blanc white (RAL 1013)	9,94	1	15	
45PY06GN	Grigio Noir Noir grey	9,94	1	15	

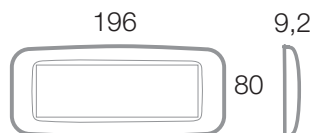

Per la disponibilità contattare  
la rete commerciale  
For availability please contact  
sales dept.



Disponibilità fino ad  
esaurimento scorte  
Available until stock out



Prodotto 2 moduli adatto  
anche per scatola tonda  
2 modules product suitable  
for round box



Prodotto per scatola  
rettangolare inglese  
Product for British standard  
rectangular box



Prodotto per Export  
For Export  
only

**1 Modulo 1 Module**

Cod. Code	Descrizione Description	Cornicetta Adapter frame	Info	€	□	□
45P21BB	Bianco Banquise (RAL 9016) Banquise white (RAL 9016)	Bianco Banquise (RAL 9016) Banquise white (RAL 9016)	3,42 1 30			
45P21BP	Bianco blanc (RAL 1013) Blanc white (RAL 1013)	Bianco Blanc (RAL 1013) Blanc white (RAL 1013)	3,42 1 30			

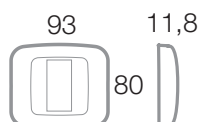
 Supporto da utilizzare  
To be used with

45362EX

347



Sistema 45

**2 Moduli 2 Modules**

45P22BB

Cod. Code	Descrizione Description	Cornicetta Adapter frame	Info	€	□	□
45P22BB	Bianco Banquise (RAL 9016) Banquise white (RAL 9016)	Bianco Banquise (RAL 9016) Banquise white (RAL 9016)	3,42 1 30			
45P22BP	Bianco blanc (RAL 1013) Blanc white (RAL 1013)	Bianco Blanc (RAL 1013) Blanc white (RAL 1013)	3,42 1 30			

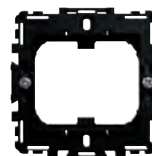
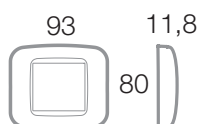
 Supporto da utilizzare  
To be used with

45362EX

**4 (2+2) Moduli 4 (2+2) Modules**

Cod. Code	Descrizione Description	Cornicetta Adapter frame	Info	€	□	□
45P24BB	Bianco Banquise (RAL 9016) Banquise white (RAL 9016)	Bianco Banquise (RAL 9016) Banquise white (RAL 9016)	5,64 1 15			
45P24BP	Bianco blanc (RAL 1013) Blanc white (RAL 1013)	Bianco Blanc (RAL 1013) Blanc white (RAL 1013)	5,64 1 15			

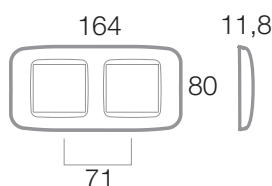
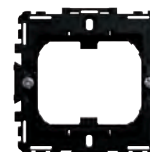
 Installazione orizzontale o  
verticale  
Horizontal and vertical  
installation

 Supporto da utilizzare  
To be used with

n° 2 45362EX

 Le dimensioni, salvo diversamente specificato, sono in mm  
Dimensions, except where otherwise specified, are in mm

 Prodotto per scatola quadrata  
Product for British Standard  
square box only

 Prodotto 1 modulo installabile in scatola tonda  
con altro prodotto 1 modulo  
1 module product installable in round box with  
another 1 module device

 Imballo Minimo pcs  
Min. Packaging pcs

 Imballo Standard pcs  
Std. Packaging pcs



# Placche

## Front Plates

# Sistema 45

Placche in tecnopolimero "Yes 45" per scatola tonda o quadrata  
 "Yes 45" series moulded front plates - square or round box

Design:  
H. M. R.

348

6(2+2+2) MODULI / 6(2+2+2) MODULES

Cod. Code	Descrizione Description	Cornicetta Adapter frame	Info	€	□	□
-----------	-------------------------	--------------------------	------	---	---	---



45P26BB	Bianco Banquise (RAL 9016) Banquise white (RAL 9016)	Bianco Banquise (RAL 9016) Banquise white (RAL 9016)	9,50	1	30	
---------	---	---	------	---	----	--

Installazione orizzontale o verticala  
Horizontal and vertical installation

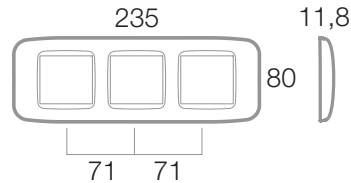

Supporto da utilizzare  
To be used with



n° 3 45362EX

Accessori placche in tecnopolimero "Yes 45" per scatola tonda o quadrata  
 "Yes 45" series moulded front plates accessories - square or round box

1 MODULO / 1 MODULE

Cod. Code	Descrizione Description	Info	€	□	□
-----------	-------------------------	------	---	---	---



45CR1BB	Cornice di ricambio 1 mod. color Banquise (RAL 9016) Banquise white (RAL 9016) 1 module spare adapter frame	1,48	5	100	
45CR1BP	Cornice di ricambio 1 mod. color Blanc (RAL 1013) Blanc (RAL 1013) white 1 module spare adapter frame	1,48	5	100	

Placche autoportanti in tecnopolimero "Yesmin" "Yesmin" series self-supporting moulded front plates

Cod. Code	Descrizione Description	Info	€	□	□
-----------	-------------------------	------	---	---	---



45PA1BB



45PA1BB	Bianco Banquise (RAL 9016) Banquise white (RAL 9016)	4,11	10	10	
45PA2BB	Bianco Banquise (RAL 9016)- con griffe Banquise white (RAL 9016) - with clips	4,11	10	10	

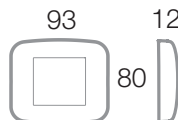

Placche in tecnopolimero multimodulo "Maxi Yes" per scatola BL02P  
 Multi-module "Maxi Yes" series moulded front plates - for BL02P box

Design:  
H. M. R.

Cod. Code	Descrizione Description	Info	€	□	□
-----------	-------------------------	------	---	---	---



45PY020BB	Bianco Banquise (RAL 9016) Banquise white (RAL 9016)	49,17	1	16	
-----------	---	-------	---	----	--

Supporto da utilizzare  
To be used with

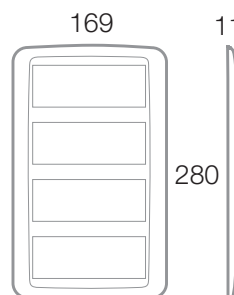

45760/20



Per la disponibilità contattare  
la rete commerciale  
For availability please contact  
sales dept.



Disponibilità fino ad  
esaurimento scorte  
Available until stock out



Prodotto 2 moduli adatto  
anche per scatola tonda  
2 modules product suitable  
for round box



Prodotto per scatola  
rettangolare inglese  
Product for British standard  
rectangular box





Prodotto per Export  
For Export  
only



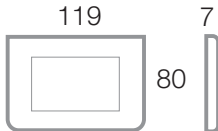

## Placche in tecnopolimero "Blanc 45" "BLANC 45" moulded front plates

Design:  
H. M. R.

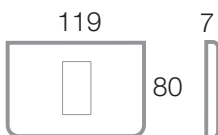

349

3 MODULI / 3 MODULES		Cod. Code	Descrizione Description	Info	€	□	□
	45P63	Bianco Blanc (RAL 1013) Blanc white (RAL 1013)	6,27	1	25		
		<b>Supporto da utilizzare</b> To be used with 		45B63			

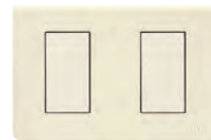
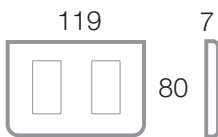

### 1 Modulo 1 Module

1 Modulo 1 Module		Cod. Code	Descrizione Description	Info	€	□	□
	45P61	Bianco Blanc (RAL 1013) Blanc white (RAL 1013)	6,27	1	25		
		<b>Supporto da utilizzare</b> To be used with 		45B63			

### 1+1 Moduli 1+1 Modules

1+1 Moduli 1+1 Modules		Cod. Code	Descrizione Description	Info	€	□	□
	45P62	Bianco Blanc (RAL 1013) Blanc white (RAL 1013)	6,27	1	25		
		<b>Supporto da utilizzare</b> To be used with 		45B63			

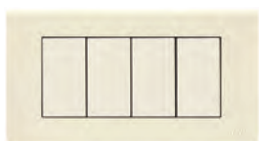
### 4 Moduli 4 Modules

4 Moduli 4 Modules		Cod. Code	Descrizione Description	Info	€	□	□
	45P64	Bianco Blanc (RAL 1013) Blanc white (RAL 1013)	8,64	1	20		
		<b>Supporto da utilizzare</b> To be used with 		45764			

Le dimensioni, salvo diversamente specificato, sono in mm  
Dimensions, except where otherwise specified, are in mm

◆ Prodotto per scatola quadrata  
Product for British Standard  
square box only

② Prodotto 1 modulo installabile in scatola tonda  
con altro prodotto 1 modulo  
1 module product installable in round box with  
another 1 module device

□ Imballo Minimo pcs  
Min. Packaging pcs

□ Imballo Standard pcs  
Std. Packaging pcs



Sistema 45

# Supporti e contenitori

## Sistema 45

**System 45**  
Frames and enclosures

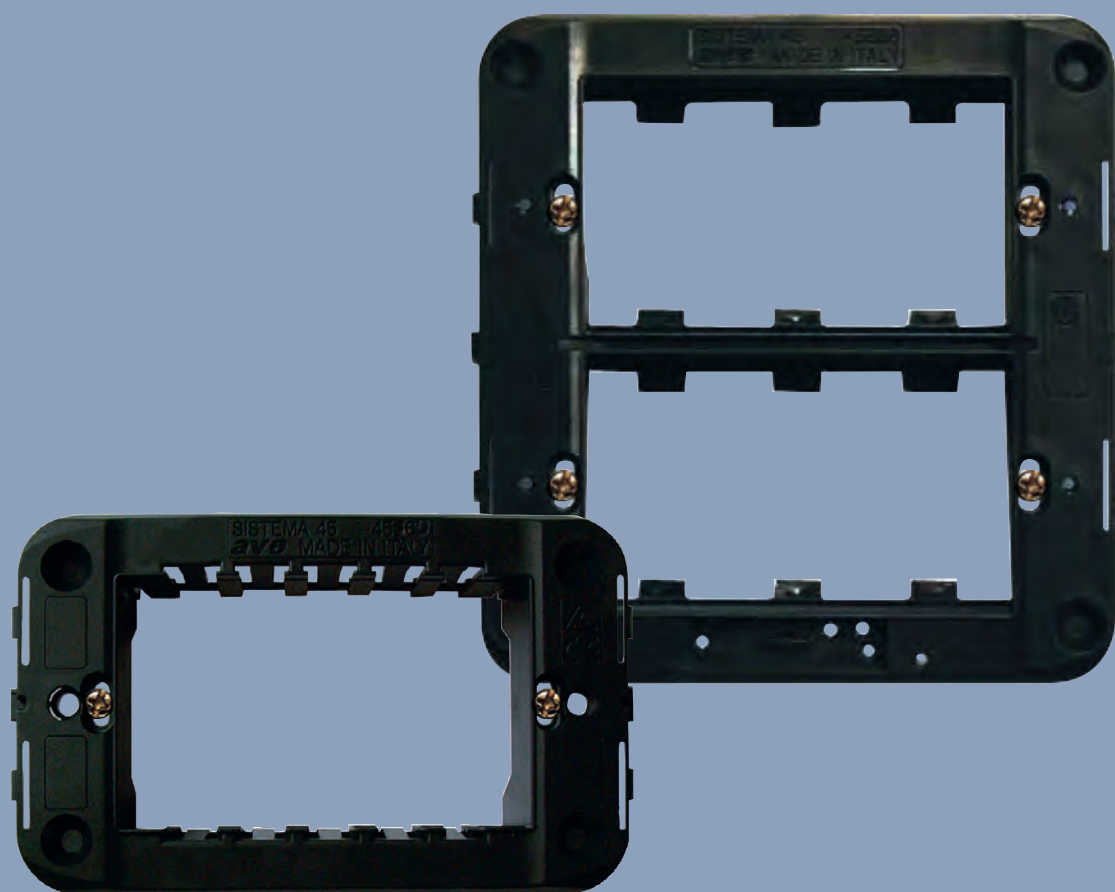

**Design:**  
B. Dall'Eco  
L. Merletti

**Indice**  
**Index**

Supporti  
Frames

**352**



Contenitori  
Enclosures

**354**







**Supporti per scatole tonde e quadrate**  
Frames for round and square boxes

352

	Cod. Code	Descrizione Description	Info	€	□	□
	45361	Supporto 1 modulo per scatola tonda 60mm per placche 45PY01..., 45P01..., 45P31, 45P61 <i>1 module frame for 60mm round box for plates 45PY01..., 45P01..., 45P31, 45P61</i>		2,72	50	50
45361						
	45762	Supporto 2 moduli affiancati per placche 45P02... - 45P92... - 45PB02... - 45PY02...45P622 - 45P722 - installabile su scatola quadrata con interasse 60mm (cod. AVE 2502) o standard rettangolare (cod. AVE 2503MG) 3 moduli <i>2 modules frame to be used with front plates 45P02...- 45P92... 45P622 - 45P722 - it can be installed on square boxes with centre distance 60 mm (code AVE 2502) or 3 modules rectangular standard (AVE code 2503MG)</i>		2,66	50	50
45762						
	45362EX	Supporto 1-2 moduli per scatola quadrata o tonda 60mm - accoppiabile in orizzontale o verticale - con griffe laterali <i>1-2 modules frame with side clips for squared or 60mm round boxes - it can be coupled either vertically or horizontally</i>		2,42	70	70
45362EX						

**Supporti per scatole rettangolari** Frames for rectangular boxes

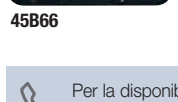
	Cod. Code	Descrizione Description	Info	€	□	□
	45B63	Supporto 1-3 moduli per scatole 2503MG <i>1-3 modules frame for 2503MG boxes</i>		1,48	120	120
45B63						
	45366	Supporto 6 moduli per scatole 2506 <i>6 modules frame for 2506 boxes</i>		5,52	8	8
45762						
	45764	Supporto 2 moduli affiancati per placche 45P02... - 45P92... - 45PB02... - 45PY02...45P622 - 45P722 - installabile su scatola quadrata con interasse 60mm (cod. AVE 2502) o standard rettangolare (cod. AVE 2503MG) - 3 moduli <i>2 modules frame to be used with front plates 45P02...-45P92... - 45PB02...45PY02...45P622 - 45P722 - it can be installed on square boxes with centre distance 60 mm (code AVE 2502) or 3 modules rectangular standard (AVE code 2503MG)</i>		2,66	50	50
45764						
	45764	Supporto 4 moduli per scatole 2504 <i>4 modules frame for 2504 boxes</i>		3,75	15	15
45B66						
	45B66	Supporto 6 moduli (3+3) per scatole BL02P <i>6 modules frame (3+3) for BL02P boxes</i>		4,62	8	8
45B66						



Per la disponibilità contattare la rete commerciale  
For availability please contact sales dept.



Disponibilità fino ad esaurimento scorte  
Available until stock out



Prodotto 2 moduli adatto anche per scatola tonda  
2 modules product suitable for round box



Prodotto per scatola rettangolare inglese  
Product for British standard rectangular box



Prodotto per Export  
For Export only

## Supporti speciali Special frames

Cod. Code	Descrizione Description	Info	€	□	□
45360	Supporto 1-3 moduli per l'installazione di tutti i prodotti che per ragioni di dimensioni <b>non possono</b> essere installati nei supporti standard sistema 45 Ave quali: - prese rasoio cod. 45...33RS - microautomatici 3KA cod. 45...52NX6,45...52NX10, 45...52NX16 - magnetotermici differenziali cod. 45...62NX6, 45...62NX10, 45...62NX16 <i>1-3 modules special frame for the devices that do not fit a standard S45 frame. The products that require this special frame are:</i> - Shaver socket (45...33RS) - 3kA Micro MCBs (45...52NX6, 45...52NX10, 45...52NX16) - Micro combined MCB/RCDs (45...62NX6, 45...62NX10, 45...62NX16)	3,08	1	12	
45364	Come sopra ma per 1-4 moduli <i>As above, for 1-4 modules</i>	4,52	1	12	



45360



45364

**Nota:** permettono inoltre, tramite gli appositi adattatori forniti in dotazione, di alloggiare tutti i frutti standard del sistema 45 Ave (vedi figura sotto riportata)  
**Note:** All standard S45 modules can be fitted to these frames by using the dedicated adaptors (see picture below)

**Esempio di installazione su Supporto 45360:**  
microinterruttore + presa schuko bipasso del Sistema 45 AVE  
**Installation example 45369 Special Use Frame, micro MCB + System 45 schuko socket**

I prodotti del Sistema 45 con aggancio standard si montano sui supporti 45360 - 45364 con l'utilizzo degli adattatori in dotazione con il supporto.

System 45 products with standard clippings are fitted to Ref. 45360 and 45364 with the adaptors provided with the frames.

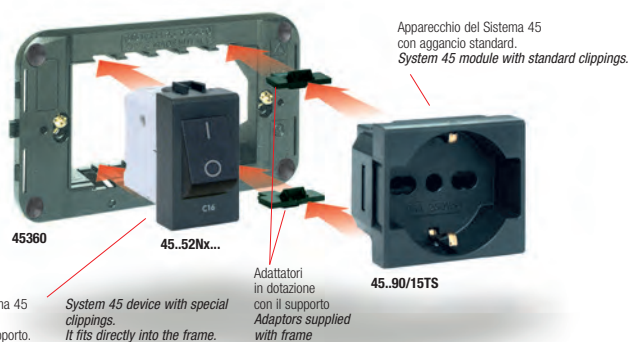

## Supporti per moduli multipli Multi-module frames

Cod. Code	Descrizione Description	Info	€	□	□
45760/10	Supporto 10 moduli per scatole 53SA05, 53SA05BG, BL05P, BL05CG, 45SY10, 45SY10AO <i>10 modules frame for 53SA05, 53SA05BG, BL05P, 45SY10, 45SY10AO boxes</i>	9,06	1	1	
45760/20	Supporto 20 moduli per scatole BL07P, 53SA12BG, , 45SY20AO <i>20 modules frame for BL07P, 53SA12BG, , 45SY20AO boxes</i>	11,23	1	1	



45760/10



45760/20

**Rimozione setto separatore**  
Divider removal



Le dimensioni, salvo diversamente specificato, sono in mm  
Dimensions, except where otherwise specified, are in mm

◇ Prodotto per scatola quadrata  
Product for British Standard square box only

② Prodotto 1 modulo installabile in scatola tonda con altro prodotto 1 modulo  
1 module product installable in round box with another 1 module device

□ Imballo Minimo pcs  
Min. Packaging pcs

□ Imballo Standard pcs  
Std. Packaging pcs



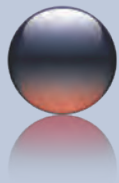

Dimensioni d'ingombro (in mm) *Dimensions (mm)*

**Caratteristiche Tecniche** *Technical Features*

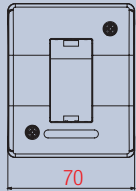

45Q41

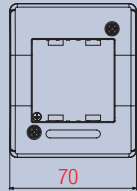
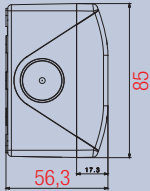

45Q42

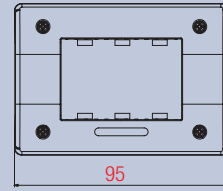
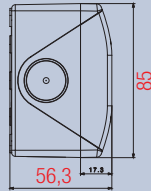

45Q43

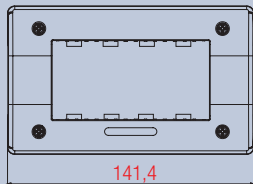
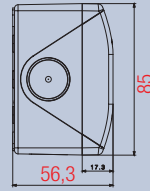

45Q44

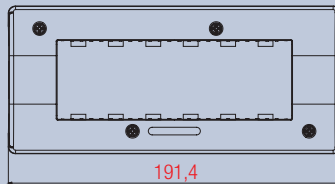
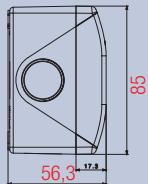

45Q46

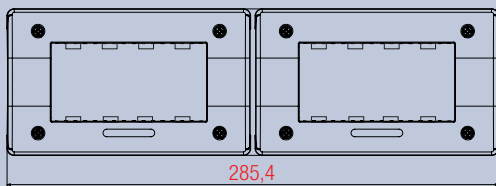
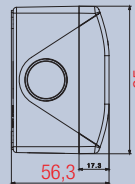

45Q48OR

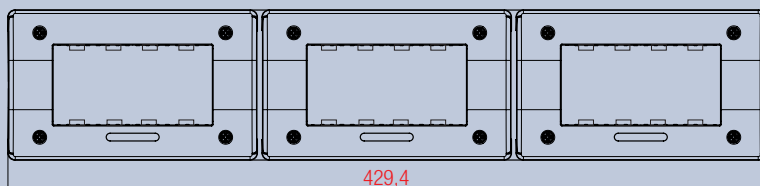
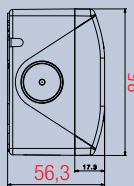

45Q412OR

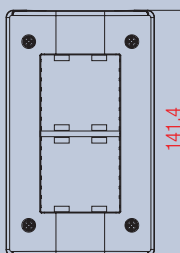
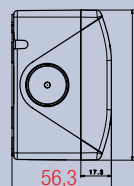

45Q44V

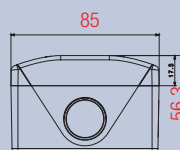

Per la disponibilità contattare la rete commerciale  
For availability please contact sales dept.



Disponibilità fino ad esaurimento scorte  
Available until stock out



Prodotto 2 moduli adatto anche per scatola tonda  
2 modules product suitable for round box







Prodotto per scatola rettangolare inglese  
Product for British standard rectangular box



Prodotto per Export  
For Export only

**Contenitori industriali autoportanti IP40 da parete RAL7035 per tubo**  
*IP40 indust. wall mounted enclosures for duct - self-supporting - RAL7035*

	<b>Cod. Code</b>	<b>Descrizione Description</b>	<b>Info</b>	<b>€</b>	<input type="checkbox"/>	<input type="checkbox"/>
	<b>45Q41</b>	1 modulo <i>1 module</i>		<b>2,65</b>	24	24
	<b>45Q42</b>	2 moduli <i>2 modules</i>		<b>2,62</b>	24	24
	<b>45Q43</b>	3 moduli <i>3 modules</i>		<b>3,76</b>	20	20
	<b>45Q44</b>	4 moduli <i>4 modules</i>		<b>4,93</b>	20	20
	<b>45Q44V</b>	4 (2+2) moduli - installazione verticale <i>4 (2+2) modules - vertical installation</i>		<b>4,97</b>	20	20
	<b>45Q43</b>	6 moduli <i>6 modules</i>		<b>7,44</b>	1	10
	<b>45Q44</b>	8 (4+4) moduli - installazione orizzontale <i>8 (4+4) modules - horizontal installation</i>		<b>8,54</b>	1	6
	<b>45Q4120R</b>	12 (4+4+4) moduli - installazione orizzontale <i>12 (4+4+4) modules - horizontal installation</i>		<b>12,20</b>	1	18



45Q41



45Q42



45Q43



45Q44



45Q46



45Q44V

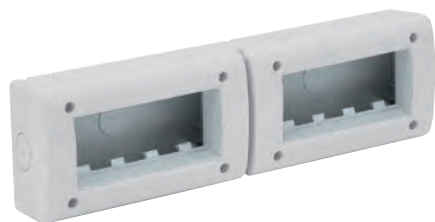

45Q480R



45Q4120R

Le dimensioni, salvo diversamente specificato, sono in mm  
 Dimensions, except where otherwise specified, are in mm

◇ Prodotto per scatola quadrata  
 Product for British Standard  
 square box only

② Prodotto 1 modulo installabile in scatola tonda  
 con altro prodotto 1 modulo  
 1 module product installable in round box with  
 another 1 module device

Imballo Minimo pcs  
 Min. Packaging pcs

Imballo Standard pcs  
 Std. Packaging pcs





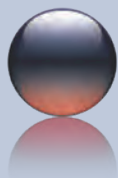

Dimensioni d'ingombro (in mm) *Dimensions (mm)*

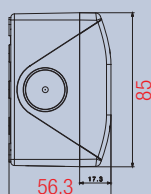
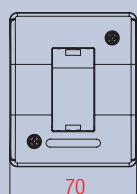
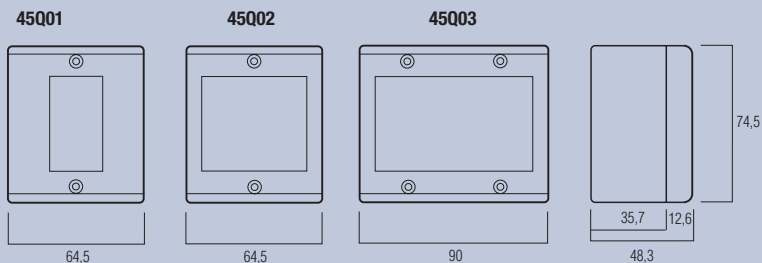

45Q41B

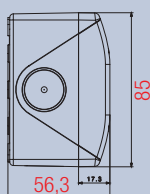
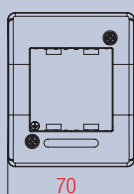

45Q42B

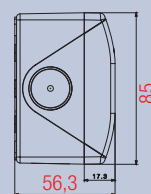
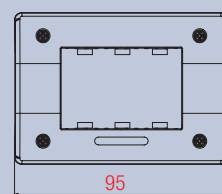

45Q43B

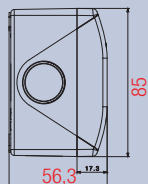
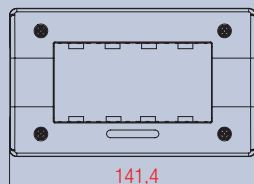

45Q44B

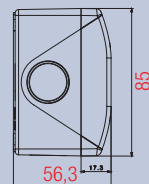
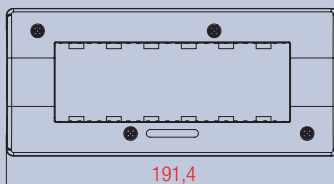

45Q46B

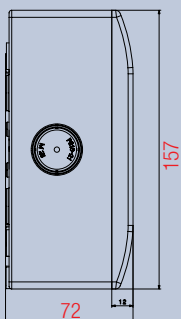
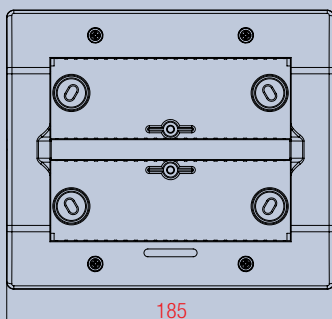

45Q412B

Caratteristiche Tecniche *Technical Features*



Per la disponibilità contattare la rete commerciale  
For availability please contact sales dept.



Disponibilità fino ad esaurimento scorte  
Available until stock out



Prodotto 2 moduli adatto anche per scatola tonda  
2 modules product suitable for round box





Prodotto per scatola rettangolare inglese  
Product for British standard rectangular box



Prodotto per Export  
For Export only

## Contenitori autoportanti IP40 da parete RAL1013

IP40 wall mounted enclosures - self-supporting - RAL1013

		Cod. Code	Descrizione Description	Info	€	□	□
		45Q01	1 modulo 1 module		3,87	30	30
		45Q02	2 moduli 2 modules		3,87	30	30
		45Q03	3 moduli 3 modules		5,25	24	24
		45Q03					







357



Sistema 45

## Contenitori industriali autoportanti IP40 da parete RAL 9016 per tubo

IP40 indust. wall mounted enclosures for duct- self-supporting - RAL 9016

		Cod. Code	Descrizione Description	Info	€	□	□
		45Q41B	1 modulo 1 module		2,65	24	24
		45Q42B	2 moduli 2 modules		2,62	24	24
		45Q43B	3 moduli 3 modules		3,76	20	20
		45Q44B	4 moduli 4 modules		4,93	20	20
		45Q43B					
		45Q44B					
		45Q46B	6 moduli 6 modules		7,44	1	10
		45Q412B	12 (6+6) moduli 12 (6+6) modules		12,14	1	6
		45Q46B					
		45Q412B					

Le dimensioni, salvo diversamente specificato, sono in mm  
Dimensions, except where otherwise specified, are in mm

◇ Prodotto per scatola quadrata  
Product for British Standard square box only

② Prodotto 1 modulo installabile in scatola tonda con altro prodotto 1 modulo  
1 module product installable in round box with another 1 module device

□ Imballo Minimo pcs  
Min. Packaging pcs

□ Imballo Standard pcs  
Std. Packaging pcs



**Scatole portafrutto da parete RAL 9016 per placche "YES 45" - per minicanale**  
*Wall mounted boxes for "YES 45" front plates RAL 9016 - for mini trunkings*

358



45SY2

Cod. Code	Descrizione Description	Info	€	□	□
45SY2	1-2 moduli - colore bianco Banquise <i>1-2 modules Banquise white box</i>		3,80	1	30

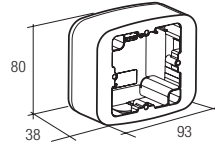

45SY2

**Scatole portafrutto da parete per placche "Ral 45" e "Zama 45"**  
*Wall mounted boxes for "Ral 45" and "Zama 45" front plates*

Cod. Code	Descrizione Description	Info	€	□	□
-----------	-------------------------	------	---	---	---



45SA03



45SA03GN

45SA03	Scatola d'arredo 3 moduli bianco Banquise (RAL 9016) - da utilizzare con supporti standard 3 moduli - completare con placche codice 45P93... o 45P03... <i>3 modules white box to be used with System 45 3 modules frames to be completed with 45P93... or 45P03... front plates</i>		7,73	1	16
--------	---	--	------	---	----

45SA03GN	Scatola d'arredo 3 moduli grigio Noir - da utilizzare con supporti standard 3 moduli. - completare con placche codice 45P93... o 45P03... <i>3 modules Noir grey box to be used with System 45 3 modules frames to be completed with 45P93... or 45P03... front plates</i>		7,73	1	16
----------	---	--	------	---	----



45CI03

45CI03	Cornice rialzatrice inclinata 3 moduli bianco Banquise (RAL 9016) <i>3 modules Banquise white (RAL 9016) angled raiser frame</i>		7,17	1	1
--------	---	--	------	---	---

**Scatole e contenitori da tavolo Desktop box and enclosures**

Cod. Code	Descrizione Description	Info	€	□	□
-----------	-------------------------	------	---	---	---



45SI03GN



45TL3BMC

45SI03GN	Scatola inclinata 3 moduli grigio Noir - da utilizzare con supporti standard 3 moduli - completare con placche codice 45P93... o 45P03... <i>3 modules Noir grey angled box to be used with System 45 3 modules frames to be completed with 45P93... or 45P03... front plates</i>		11,61	1	1
----------	--	--	-------	---	---

45TL3BMC	Contenitore autoportante da tavolo 3 moduli bianco Banquise (RAL 9016) - completo di placca color bianco Banquise micalizzato <i>3 modules Banquise white (RAL 9016) desktop enclosure with mica-finished Banquise white front plate</i>		34,71	1	12
----------	---	--	-------	---	----



Per la disponibilità contattare la rete commerciale  
For availability please contact sales dept.



Disponibilità fino ad esaurimento scorte  
Available until stock out



Prodotto 2 moduli adatto anche per scatola tonda  
2 modules product suitable for round box



Prodotto per scatola rettangolare inglese  
Product for British standard rectangular box



Prodotto per Export  
For Export only

## Placche stagne (IP55) autoportanti con sportello con membrana cedibile IP55 front plates with soft membrane cover - self-supporting

		Cod. Code	Descrizione Description	Info	€	□	□
		45SP43N	Placca 3 moduli stagna con membrana - autoportante (non necessita di supporto portafrutti) - grigio RAL 7035 <i>IP55 splashproof 3 modules front plate with soft membrane cover - self-supporting (no frame is required) - RAL 7035 grey</i>		9,73	6	6
		45SP43BN	Placca 3 moduli stagna con membrana - autoportante (non necessita di supporto portafrutti) - bianco Banquise (RAL 9016) <i>IP55 splashproof 3 modules front plate with soft membrane cover - self-supporting (no frame is required) - Banquise white (RAL 9016)</i>		10,06	6	6
		45SP43BPN	Placca 3 moduli stagna con membrana - autoportante (non necessita di supporto portafrutti) - bianco Blanc (RAL 1013) <i>IP55 splashproof 3 modules front plate with soft membrane cover - self-supporting (no frame is required) - Blanc white (RAL 1013)</i>		10,06	6	6
		45SP43GM	Placca 3 moduli stagna con membrana - autoportante (non necessita di supporto portafrutti) - grigio metallizzato <i>IP55 splashproof 3 modules front plate with soft membrane cover - self-supporting (no frame is required) - Metallic grey</i>		11,28	6	6
		45SP44	Placca 4 moduli stagna con membrana - autoportante (non necessita di supporto portafrutti) grigio RAL 7035 <i>4 modules splash proof front plate - self-supporting (no frame is required) - RAL 7035 grey</i>		14,03	6	6
		45SP44B	Placca 4 moduli stagna con membrana autoportante (non necessita di supporto portafrutti) bianco Banquise (RAL 9016) <i>4 modules splash proof front plate - self-supporting (no frame is required) - Banquise white (RAL 9016)</i>		14,03	6	6

**Nota:** grado di protezione garantito IP55 con apparecchi di comando o altri apparecchi modulari che consentano la chiusura dello sportello nella condizione ordinaria di servizio  
**Note:** IP55 protection degree guaranteed with control devices or other modular devices that allow the closure of the cover in ordinary performing conditions

## Placche stagne (IP44) con sportello rigido IP44 front plates with rigid cover

		Cod. Code	Descrizione Description	Info	€	□	□
		45SPQ02	Placca 2 moduli con sportello rigido - autoportante (non necessita di supporto portafrutti) - fissaggio con viti su scatola quadrata con interasse 60mm - RAL 7035 <i>IP44 2 modules front plate with rigid cover - self-supporting (no frame is required) To be fixed by screws on square box interax 60mm - RAL 7035</i>		13,06	1	8

**Nota:** grado di protezione garantito IP44 con apparecchi di comando o altri apparecchi modulari che consentano la chiusura dello sportello nella condizione ordinaria di servizio  
**Note:** IP44 protection degree guaranteed with control devices or other modular devices that allow the closure of the lid in ordinary performing conditions

### Installazione Installation



Scatola da incasso cod. 2502  
Flush-mounted box code 2502

Sportello rigido antiurto: non ingiallisce anche se esposto a raggi solari diretti  
Anti-shock rigid cover: it doesn't yellow even if directly exposed to sunbeams

Apparecchi Sistema 45 AVE  
System 45 AVE devices

Le dimensioni, salvo diversamente specificato, sono in mm  
Dimensions, except where otherwise specified, are in mm

◇ Prodotto per scatola quadrata  
Product for British Standard square box only

② Prodotto 1 modulo installabile in scatola tonda con altro prodotto 1 modulo  
1 module product installable in round box with another 1 module device

□ Imballo Minimo pcs  
Min. Packaging pcs

□ Imballo Standard pcs  
Std. Packaging pcs

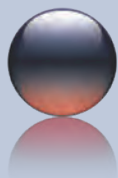

# Contenitori

## Enclosures

Contenitori stagni (IP55) autoportanti da parete RAL 7035 con sportello a membrana cedibile per tubo  
IP55 wall mounted enclosures RAL 7035 with soft membrane cover - self-supporting for duct

360

Dimensioni d'ingombro (in mm) *Dimensions (mm)*

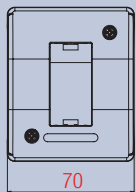

45Q41B

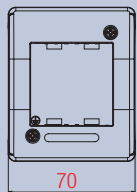
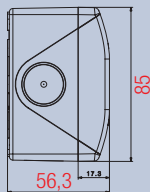

45Q42B

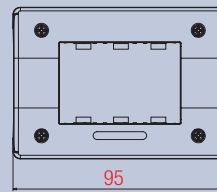
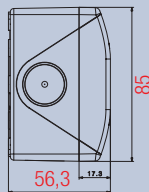

45Q43B

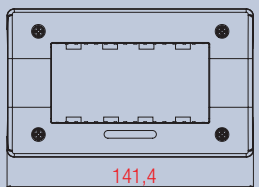
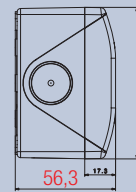

45Q44B

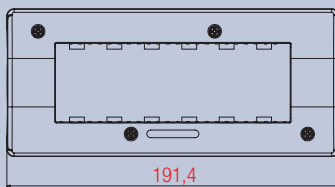
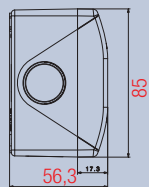

45Q46B

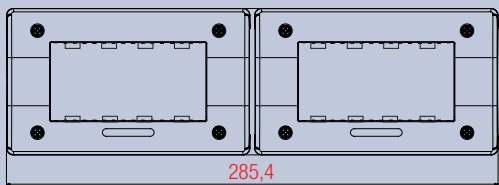
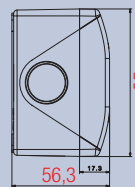

45Q480R

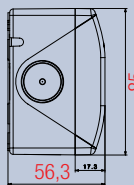

Caratteristiche Tecniche *Technical Features*

Soluzioni IP55/IP66 multiple da parete per tubo

Wall mounted double enclosures IP55/IP66 solutions for duct

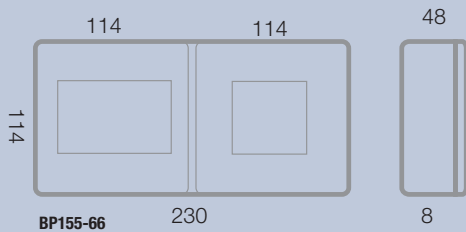

BP155-66

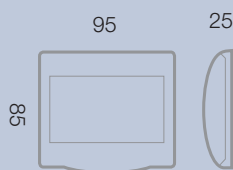

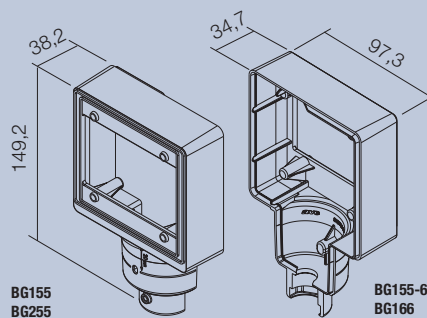

45SP43K



BG155  
BG255

BG155-66  
BG166  
BG266

## Contenitori stagni (IP55) autoportanti da parete RAL 7035 con sportello a membrana cedibile per tubo IP55 wall mounted enclosures RAL 7035 with soft membrane cover - self-supporting for duct

		Cod. Code	Descrizione Description	Info	€	□	□
		45ST01	Contenitore da parete 1 modulo 1 module wall mounted enclosure		5,10	1	24
		45ST02	Contenitore da parete 2 moduli 2 modules wall mounted enclosure		5,10	1	24
		45ST03	Contenitore da parete 3 moduli 3 modules wall mounted enclosure		7,57	1	20
		45ST04	Contenitore da parete 4 moduli 4 modules wall mounted enclosure		13,00	20	20





**Nota:** grado di protezione garantito IP55 con apparecchi di comando o altri apparecchi modulari che consentano la chiusura dello sportello nella condizione ordinaria di servizio  
**Note:** IP55 protection degree guaranteed with control devices or other modular devices that allow the closure of the lid in ordinary performing conditions

361



Sistema 45

## Soluzioni IP55/IP66 multiple da parete per tubo Wall mounted double enclosures IP55/IP66 solutions for duct

		Cod. Code	Descrizione Description	Info	€	□	□
		BP155-66	Box da parete per 3 moduli IP55 + 2 moduli AVE SEAL - da completare con n° 1 45SP43K + n° 1 44SP42K - grado di protezione garantito IP55 con apparecchi di comando (*) da un lato e prese dall'altro Wall mounted box for IP55 3 modules + AVE SEAL 2 modules to be completed with n°1 45SP43K + n° 1 44SP42K - IP55 protection degree guaranteed with control devices (*) on the one hand and sockets on the other hand		20,57	1	1
		45SP43K	Coperchio 3 moduli con sportello con membrana cedibile 3 modules cover with soft membrane lid		9,78	1	8
		BG155	Box testa-palo a 1 fronte IP55 - installabile su palo BG100 - da completare con n° 1 45SP43K - grado di protezione garantito IP55 con apparecchi di comando (*) Box on pole top with 1 IP55 front - to be installed on pole BG100 to be completed with n. 1 45SP43K - IP55 protection degree guaranteed with control devices (*)		14,58	1	1
		BG155-66	Box testa-palo a 2 fronti IP66 + IP55 - installabile su palo BG100 - da completare con n° 1 44SP42K + n° 1 45SP43K - grado di protezione garantito IP55 con apparecchi di comando (*) da un lato e prese dall'altro Box on pole top with 2 IP66 + IP55 fronts - to be installed on pole BG100 to be completed with n. 1 44SP42K - IP55 protection degree guaranteed with control devices (*) on the one hand and sockets on the other hand		20,79	1	1
		BG100	Palo isolante per box testa palo - Ø esterno 60mm - lunghezza 1 Insulating pole for garden enclosures - external Ø 60mm - length 1m		37,62	1	1

Le dimensioni, salvo diversamente specificato, sono in mm  
Dimensions, except where otherwise specified, are in mm

◇ Prodotto per scatola quadrata  
Product for British Standard square box only

② Prodotto 1 modulo installabile in scatola tonda con altro prodotto 1 modulo  
1 module product installable in round box with another 1 module device

□ Imballo Minimo pcs  
Min. Packaging pcs

□ Imballo Standard pcs  
Std. Packaging pcs