

# Ventilazione e controllo dell'ambiente

## Ventilation and environment control



BASSO E BASSISSIMO CONSUMO  
*LOW AND VERY LOW CONSUMPTION*



SILENZIOSITÀ  
*NOISELESSNESS*



LUNGA DURATA  
*LONG LIFE*



ALETTE AUTOMATICHE  
*AUTOMATIC SHUTTERS*

**Design:**

B. Dall'Eco  
L. Merletti



Aspiratori assiali  
Axial fans

**652**



Aspiratori centrifughi  
Centrifugal fans

**668**



Accessori per aspiratori  
Accessories for fans

**672**



Ventilazione Meccanica Controllata  
Controlled Mechanical Ventilation

**674**



Accessori per VMC  
Accessories for CMV

**682**

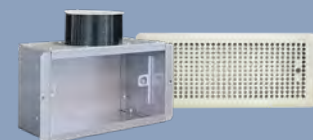



## **DomusAir - Ventilazione residenziale**

*DomusAir - Residential ventilation*

650

- **Aspirazione residenziale**
- **Ricambio aria puntuale**
- **Ricambio aria centralizzato**

- **Residential suction**
- **Timely air exchange**
- **Centralized air exchange**

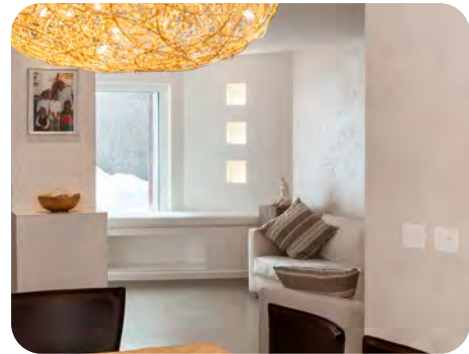

# Controllo Ambiente *Environmental Control*

## Domusair™







# DomusAir - Ventilazione residenziale

## DomusAir - Residential ventilation

Aspiratori assiali "AXIAL"- IPX4

Axial fans IPX4 - "AXIAL"

652

Descrizione Description

Info

€

□

□



VND90  
VND90T



### VND90

Aspiratore assiale Ø90mm - frontale design - motore con cuscinetti a sfera (long life) - portata massima 55 m³/h - per installazione in bagno, toilette e piccoli ambienti.

Versione base.

*Axial fan Ø90mm - stylish front cover - ball bearing motor (long life) - max air flow 55 m³/h - for installation in bathrooms, toilets and small living areas.*

*Basic version.*



70,81

1

1

### VND90T

Aspiratore assiale Ø90mm - frontale design - motore con cuscinetti a sfera (long life) - portata massima 55 m³/h - per installazione in bagno, toilette e piccoli ambienti.

Versione con timer.

*Axial fan Ø90mm - stylish front cover - ball bearing motor (long life) - max air flow 55 m³/h - for installation in bathrooms, toilets and small living areas.*

*Timer version.*



101,60

1

1

### VND100

Aspiratore assiale Ø100mm - frontale design - motore con cuscinetti a sfera (long life) - portata massima 83 m³/h - per installazione in bagno, toilette e piccoli ambienti.

Versione base.

*Axial fan Ø100mm - stylish front cover - ball bearing motor (long life) - max air flow 83 m³/h - for installation in bathrooms, toilets and small living areas.*

*Basic version.*



74,98

1

1



VND100  
VND100T  
VND100HT



### VND100T

Aspiratore assiale Ø100mm - frontale design - motore con cuscinetti a sfera (long life) - portata massima 83 m³/h - per installazione in bagno, toilette e piccoli ambienti.

Versione con timer.

*Axial fan Ø100mm - stylish front cover - ball bearing motor (long life) - max air flow 83 m³/h - for installation in bathrooms, toilets and small living areas.*

*Timer version.*



110,59

1

1

### VND100HT

Aspiratore assiale Ø100mm - frontale design - motore con cuscinetti a sfera (long life) - portata massima 83 m³/h - per installazione in bagno, toilette e piccoli ambienti.

Versione con umidostato & timer.

*Axial fan Ø100mm - stylish front cover - ball bearing motor (long life) - max air flow 83 m³/h - for installation in bathrooms, toilets and small living areas.*

*Humidistat & timer version.*



157,71

1

1

### VND120

Aspiratore assiale Ø120mm - frontale design - motore con cuscinetti a sfera (long life) - portata massima 140 m³/h - per installazione in bagno, toilette e piccoli/medi ambienti.

Versione base.

*Axial fan Ø120mm - stylish front cover - ball bearing motor (long life) - max air flow 140 m³/h - for installation in bathrooms, toilets and small/medium living areas.*

*Basic version.*



96,81

1

1

### VND120T

Aspiratore assiale Ø120mm - frontale design - motore con cuscinetti a sfera (long life) - portata massima 140 m³/h - per installazione in bagno, toilette e piccoli/medi ambienti.

Versione con timer.

*Axial fan Ø120mm - stylish front cover - ball bearing motor (long life) - max air flow 140 m³/h - for installation in bathrooms, toilets and small/medium living areas.*

*Timer version.*



127,92

1

1



VND120  
VND120T  
VND120HT



### VND120HT

Aspiratore assiale Ø120mm - frontale design - motore con cuscinetti a sfera (long life) - portata massima 140 m³/h - per installazione in bagno, toilette e piccoli/medi ambienti.

Versione con umidostato & timer.

*Axial fan Ø120mm - stylish front cover - ball bearing motor (long life) - max air flow 140 m³/h - for installation in bathrooms, toilets and small/medium living areas.*

*Humidistat & timer version.*



180,44

1

1



Per la disponibilità contattare la rete commerciale  
For availability please contact sales dept.



Disponibilità fino ad esaurimento scorte  
Available until stock out

## Aspiratori assiali "AXIAL"- IPX4 Axial fans IPX4 - "AXIAL"



VND150  
VND150T



### Descrizione Description

Info

€

□

□

653

#### VND150

Aspiratore assiale Ø150mm - frontale design - motore con cuscinetti a sfera (long life) - portata massima 253 m<sup>3</sup>/h - per installazione in bagno, toilette e medi ambienti. Versione base.

*Axial fan Ø150mm - stylish front cover - ball bearing motor (long life) - max air flow 253 m<sup>3</sup>/h - for installation in bathrooms, toilets and medium living areas. Basic version.*



176,60 1 1

#### VND150T

Aspiratore assiale Ø150mm - frontale design - motore con cuscinetti a sfera (long life) - portata massima 253 m<sup>3</sup>/h - per installazione in bagno, toilette e medi ambienti.

Versione con timer.  
*Axial fan Ø150mm - stylish front cover - ball bearing motor (long life) - max air flow 253 m<sup>3</sup>/h - for installation in bathrooms, toilets and medium living areas. Timer version.*



195,26 1 1

## Aspiratori assiali "AXIAL"- IPX4 - versione con motore a bronzine Axial fans IPX4 - "AXIAL" - with sleeve bearing motor



VND100B  
VND100TB



### Descrizione Description

Info

€

□

□

#### VND100B

Aspiratore assiale Ø100mm - frontale design - motore con bronzine - portata massima 83 m<sup>3</sup>/h - per installazione in bagno, toilette e piccoli ambienti. Versione base.

*Axial fan Ø100mm - stylish front cover - sleeve bearing motor - max air flow 83 m<sup>3</sup>/h - for installation in bathrooms, toilets and small living areas. Basic version.*



56,13 1 1

#### VND100TB

Aspiratore assiale Ø100mm - frontale design - motore con bronzine - portata massima 83 m<sup>3</sup>/h - per installazione in bagno, toilette e piccoli ambienti. Versione con timer.

*Axial fan Ø100mm - stylish front cover - sleeve bearing motor - max air flow 83 m<sup>3</sup>/h - for installation in bathrooms, toilets and small living areas. Timer version.*



89,75 1 1

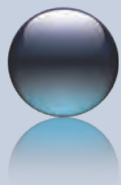

## DomusAir - Ventilazione residenziale

### DomusAir - Residential ventilation

#### Aspiratori assiali "AXIAL"- IPX4

#### Axial fans IPX4 - "AXIAL"

654

L'aspiratore assiale è la soluzione ideale per estrarre significativi volumi d'aria viziata direttamente all'esterno. Poiché genera una bassa pressione, esso deve essere collegato ad un condotto di diametro appropriato e di lunghezza minore a 1,5m.

Un'installazione errata può compromettere il corretto funzionamento e/o il rendimento dell'aspiratore.

*The axial fan is the ideal solution to extract significant volumes of stale air directly outside. Since it generates limited pressure, it must be connected to the appropriate diameter duct less than 1,5m long.*

*Improper installation may result in an incorrect operation and/or decrease of the fan performance.*

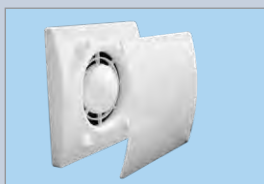

copri-frontale design rimovibile  
removable stylish front cover

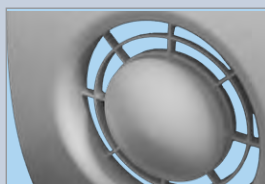

ogiva centrale aerodinamica  
aerodynamic-shaped inlet



accessorio chiusura a farfalla  
back-draught shutter accessory

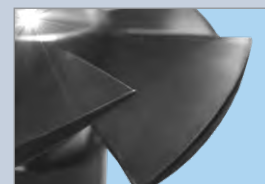

ventola con pale a "winglet"  
winglet-type impeller

#### Prestazioni Performance

Codice Code	Modello Model	Portata Air flow m³/h max	Pressione statica Static pressure Pa max	Alimentazione Power supply V~	Consumo Power W max	Pressione sonora Sound Pressure dB(A) @3m	Temp.ambiente Ambient temp. °C max	Marcatura Marking
VND90	AXIAL	55	17	220-240 50/60Hz	8	26	50	CE
VND90T	AXIAL	55	17	220-240 50/60Hz	8	26	50	CE
VND100	AXIAL	83	27	220-240 50/60Hz	8	26	50	CE
VND100T	AXIAL	83	27	220-240 50/60Hz	8	26	50	CE
VND100HT	AXIAL	83	27	220-240 50/60Hz	8	26	50	CE
VND120	AXIAL	140	40	220-240 50/60Hz	14	34	50	CE
VND120T	AXIAL	140	40	220-240 50/60Hz	14	34	50	CE
VND120HT	AXIAL	140	40	220-240 50/60Hz	14	34	50	CE
VND150	AXIAL	253	51	220-240 50/60Hz	24	42	50	CE
VND150T	AXIAL	253	51	220-240 50/60Hz	24	42	50	CE
VND100B	AXIAL	83	27	220-240 50/60Hz	8	26	50	CE
VND100TB	AXIAL	83	27	220-240 50/60Hz	8	26	50	CE

- Note/Notes:**
- ✓ prestazioni aerauliche misurate secondo ISO 5801 a 230V 50Hz, densità dell'aria 1,2 Kg/m³  
air performance measured according to ISO 5801 at 230V 50Hz, air density 1,2 Kg/m³
  - ✓ dati misurati in laboratorio accreditato TÜV Rheinland  
data measured in TÜV Rheinland accredited laboratory



Per la disponibilità contattare la rete commerciale  
For availability please contact sales dept.



Disponibilità fino ad esaurimento scorte  
Available until stock out

**Aspiratori assiali "AXIAL"- IPX4**  
*Axial fans IPX4 - "AXIAL"*

**Dimensioni (mm) Dimensions (mm)**

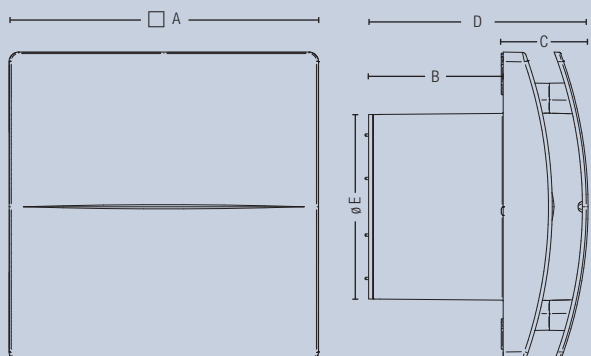

Codice Code	A	B	C	D	ØE
VND90 - VND90T	164	55	46	101	90
VND100 - VND100T - VND100HT	164	70	46	116	99
VND120 - VND120T - VND120HT	184	81	48	129	119
VND150 - VND150T	218	97	52	149	148
VND100B - VND100TB	164	70	46	116	99

**Installazione Installation**

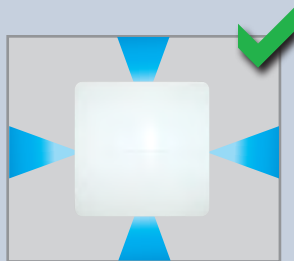

aspirazione perimetrale  
*perimetral extraction*

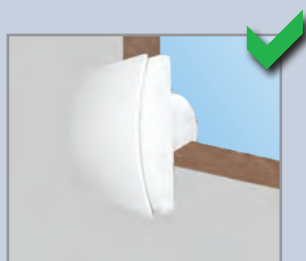

parete / pannello  
*wall/panel*

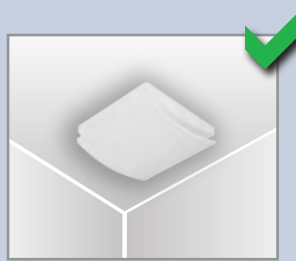

soffitto (accessorio a richiesta)  
*ceiling (accessory on request)*

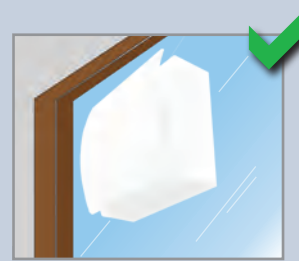

finestra (accessorio a richiesta)  
*window (accessory on request)*

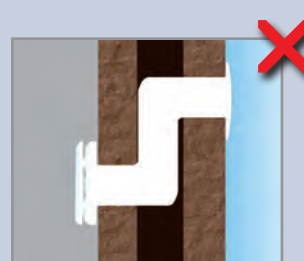
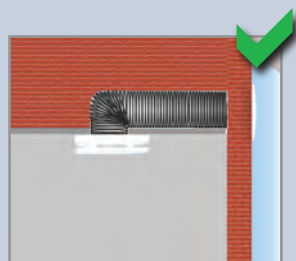

breve tratto di canalizzazione  
*short length of ducting*

**Comandi e sensori ambiente Controls and ambient sensors**



**Regolatore velocità**  
*Speed controller*  
 441048M (Domus)



**Timer**  
*Timer*  
 441021 (Domus)



**Igrostato**  
*Hygrostat*  
 441079 (Domus)  
 442079 (Life)  
 443079 (Allumia)  
 445079 (Tekla)  
 449079 (Class)



**Rilevatore PIR**  
*PIR sensor*  
 441068RL (Domus)  
 442068RL (Life)  
 443068RL (Allumia)  
 445068RL (Tekla)  
 446068RL (Whitek)  
 449068RL (Class)

Le dimensioni, salvo diversamente specificato, sono in mm  
 Dimensions, except where otherwise specified, are in mm

 Imballo Minimo pcs  
 Min. Packaging pcs

 Imballo Standard pcs  
 Std. Packaging pcs





# DomusAir - Ventilazione residenziale

## DomusAir - Residential ventilation

Aspiratori assiali "ELICAL TOP" - IPX4  
Axial fans IPX4 - "ELICAL TOP"

656

Descrizione Description

Info

€



VNS90



### VNS90

Aspiratore assiale Ø90mm - motore con cuscinetti a sfera (long life)  
- portata massima 60 m³/h - per installazione in bagno, toilette e piccoli ambienti.

Versione base.

*Axial fan Ø90mm - ball bearing motor (long life) - max air flow 60 m³/h - for installation in bathrooms, toilets and small living areas.*

*Basic version.*



78,31

1

1



VNS100  
VNS100HT



### VNS100

Aspiratore assiale Ø100mm - motore con cuscinetti a sfera (long life)  
- portata massima 88 m³/h - per installazione in bagno, toilette e piccoli ambienti.

Versione base.

*Axial fan Ø100mm - ball bearing motor (long life) - max air flow 88 m³/h - for installation in bathrooms, toilets and small living areas.*

*Basic version.*



77,42

1

1



VNS120HT



### VNS100HT

Aspiratore assiale Ø100mm - motore con cuscinetti a sfera (long life)  
- portata massima 88 m³/h - per installazione in bagno, toilette e piccoli ambienti.

Versione con umidostato & timer.

*Axial fan Ø100mm - ball bearing motor (long life) - max air flow 88 m³/h - for installation in bathrooms, toilets and small living areas.*

*Humidistat & timer version.*



136,43

1

1

### VNS120HT

Aspiratore assiale Ø120mm - motore con cuscinetti a sfera (long life)  
- portata massima 175 m³/h - per installazione in bagno, toilette e piccoli/medi ambienti.

Versione con umidostato & timer.

*Axial fan Ø120mm - ball bearing motor (long life) - max air flow 175 m³/h - for installation in bathrooms, toilets and small/medium living areas.*

*Humidistat & timer version.*



171,97

1

1



Per la disponibilità contattare la rete commerciale  
For availability please contact sales dept.



Disponibilità fino ad esaurimento scorte  
Available until stock out

**Aspiratori assiali "ELICAL" - IPX4**  
Axial fans IPX4 - "ELICAL"

		Descrizione Description	Info	€	<input type="checkbox"/>	<input type="checkbox"/>	657
	 	<b>VNS90B</b> Aspiratore assiale Ø90mm - motore con bronzine - portata massima 60 m³/h - per installazione in bagno, toilette e piccoli ambienti. Versione base. <i>Axial fan Ø90mm - sleeve bearing motor - max air flow 60 m³/h - for installation in bathrooms, toilets and small living areas. Basic version.</i>		53,41	1	1	
		<b>VNS90TB</b> Aspiratore assiale Ø90mm - motore con bronzine - portata massima 60 m³/h - per installazione in bagno, toilette e piccoli ambienti. Versione con timer. <i>Axial fan Ø90mm - sleeve bearing motor - max air flow 60 m³/h - for installation in bathrooms, toilets and small living areas. Timer version.</i>		83,12	1	1	
	 	<b>VNS100B</b> Aspiratore assiale Ø100mm - motore con bronzine - portata massima 88 m³/h - per installazione in bagno, toilette e piccoli ambienti. Versione base. <i>Axial fan Ø100mm - sleeve bearing motor - max air flow 88 m³/h - for installation in bathrooms, toilets and small living areas. Basic version.</i>		58,41	1	1	
		<b>VNS100TB</b> Aspiratore assiale Ø100mm - motore con bronzine - portata massima 88 m³/h - per installazione in bagno, toilette e piccoli ambienti. Versione con timer. <i>Axial fan Ø100mm - sleeve bearing motor - max air flow 88 m³/h - for installation in bathrooms, toilets and small living areas. Timer version.</i>		98,00	1	1	
		<b>VNS120B</b> Aspiratore assiale Ø120mm - motore con bronzine - portata massima 175 m³/h - per installazione in bagno, toilette e piccoli/medi ambienti. Versione base. <i>Axial fan Ø120mm - sleeve bearing motor - max air flow 175 m³/h - for installation in bathrooms, toilets and small/medium living areas. Basic version.</i>		78,67	1	1	
		<b>VNS120TB</b> Aspiratore assiale Ø120mm - motore con bronzine - portata massima 175 m³/h - per installazione in bagno, toilette e piccoli/medi ambienti. Versione con timer. <i>Axial fan Ø120mm - sleeve bearing motor - max air flow 175 m³/h - for installation in bathrooms, toilets and small/medium living areas. Timer version.</i>		112,63	1	1	
		<b>VNS150B</b> Aspiratore assiale Ø150mm - motore con bronzine - portata massima 330 m³/h - per installazione in bagno, toilette e medi ambienti. Versione base. <i>Axial fan Ø150mm - sleeve bearing motor - max air flow 330 m³/h - for installation in bathrooms, toilets and medium living areas. Basic version.</i>		151,48	1	1	
		<b>VNS150TB</b> Aspiratore assiale Ø150mm - motore con bronzine - portata massima 330 m³/h - per installazione in bagno, toilette e medi ambienti. Versione con timer. <i>Axial fan Ø150mm - sleeve bearing motor - max air flow 330 m³/h - for installation in bathrooms, toilets and medium living areas. Timer version.</i>		186,02	1	1	

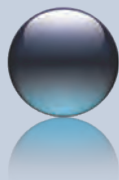

## DomusAir - Ventilazione residenziale

### DomusAir - Residential ventilation

Aspiratori assiali "ELICAL TOP" - "ELICAL" - IPX4  
Axial fans IPX4 - "ELICAL TOP" - "ELICAL"

658

L'aspiratore assiale è la soluzione ideale per estrarre significativi volumi d'aria viziata direttamente all'esterno. Poiché genera una bassa pressione, esso deve essere collegato ad un condotto di diametro appropriato e di lunghezza minore a 1,5m.

Un'installazione errata può compromettere il corretto funzionamento e/o il rendimento dell'aspiratore.

*The axial fan is the ideal solution to extract significant volumes of stale air directly outside. Since it generates limited pressure, it must be connected to the appropriate diameter duct less than 1,5m long.*

*Improper installation may result in an incorrect operation and/or decrease of the fan performance.*

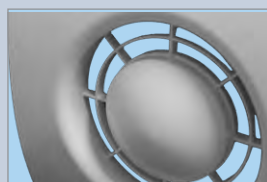

ogiva centrale aerodinamica  
aerodynamic-shaped inlet



accessorio chiusura a farfalla  
back-draught shutter accessory

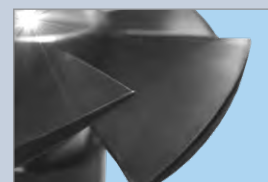

ventola con pale a "winglet"  
winglet-type impeller

#### Prestazioni Performance

Code Codice	Modello Model	Portata Air flow m³/h max	Pressione statica Static pressure Pa max	Alimentazione Power supply V~	Consumo Power W max	Pressione sonora Sound Pressure dB(A) @3m	Temp.ambiente Ambient temp. °C max	Marcatura Marking
VNS90	ELICAL TOP	60	17	220-240 50/60Hz	8	26	50	CE
VNS100	ELICAL TOP	88	27	220-240 50/60Hz	8	26	50	CE
VNS100HT	ELICAL TOP	88	27	220-240 50/60Hz	8	26	50	CE
VNS120HT	ELICAL TOP	175	40	220-240 50/60Hz	14	33	50	CE

Code Codice	Modello Model	Portata Air flow m³/h max	Pressione statica Static pressure Pa max	Alimentazione Power supply V~	Consumo Power W max	Pressione sonora Sound Pressure dB(A) @3m	Temp.ambiente Ambient temp. °C max	Marcatura Marking
VNS90B	ELICAL	60	17	220-240 50/60Hz	8	26	50	CE
VNS90TB	ELICAL	60	17	220-240 50/60Hz	8	26	50	CE
VNS100B	ELICAL	88	27	220-240 50/60Hz	8	26	50	CE
VNS100TB	ELICAL	88	27	220-240 50/60Hz	8	26	50	CE
VNS120B	ELICAL	175	40	220-240 50/60Hz	14	33	50	CE
VNS120TB	ELICAL	175	40	220-240 50/60Hz	14	33	50	CE
VNS150B	ELICAL	330	59	220-240 50/60Hz	24	42	50	CE
VNS150TB	ELICAL	330	59	220-240 50/60Hz	24	42	50	CE

- Note/Notes:**
- ✓ prestazioni aerauliche misurate secondo ISO 5801 a 230V 50Hz, densità dell'aria 1,2 Kg/m³  
air performance measured according to ISO 5801 at 230V 50Hz, air density 1,2 Kg/m³
  - ✓ dati misurati in laboratorio accreditato TÜV Rheinland  
data measured in TÜV Rheinland accredited laboratory



Per la disponibilità contattare  
la rete commerciale  
For availability please contact  
sales dept.



Disponibilità fino ad  
esaurimento scorte  
Available until stock out

**Aspiratori assiali "ELICAL TOP" - "ELICAL" - IPX4**  
*Axial fans IPX4 - "ELICAL TOP" - "ELICAL"*

**Dimensioni (mm) Dimensions (mm)**

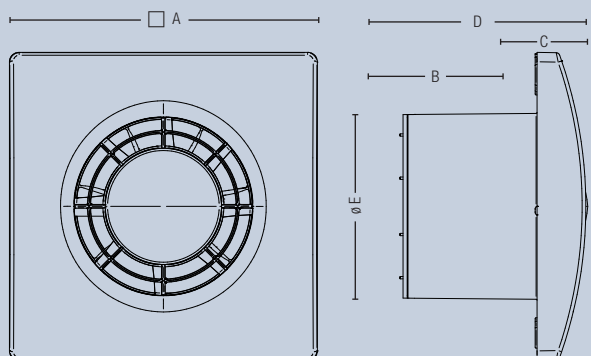

Codice Code	A	B	C	D	ØE
VNS90	164	55	28	83	90
VNS100 - VNS100HT	164	70	28	98	99
VNS120HT	184	81	27	108	119

Codice Code	A	B	C	D	ØE
VNS90B - VNS90TB	164	55	28	83	90
VNS100B - VNS100TB	164	70	28	98	99
VNS120B - VNS120TB	184	81	27	108	119
VNS150B - VNS150TB	218	97	27	124	148

**Installazione Installation**



aspirazione centrale  
central extraction



parete / pannello  
wall/panel

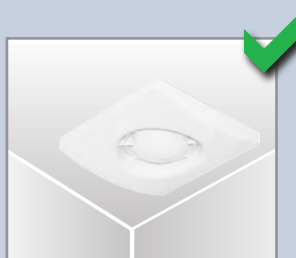

soffitto (accessorio a richiesta)  
ceiling (accessory on request)



finestra (accessorio a richiesta)  
finestra (accessory on request)

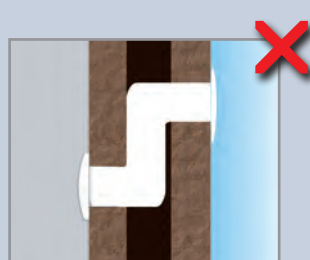
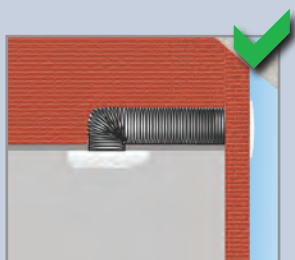

breve tratto di canalizzazione  
short length of ducting

**Comandi e sensori ambiente Controls and ambient sensors**



**Regolatore velocità**  
Speed controller  
441048M (Domus)



**Timer**  
Timer  
441021 (Domus)



**Igrostato**  
Hygrostat  
441079 (Domus)  
442079 (Life)  
443079 (Allumia)  
445079 (Tekla)  
449079 (Class)



**Rilevatore PIR**  
PIR sensor  
441068RL (Domus)  
442068RL (Life)  
443068RL (Allumia)  
445068RL (Tekla)  
446068RL (Whitek)  
449068RL (Class)

Le dimensioni, salvo diversamente specificato, sono in mm  
Dimensions, except where otherwise specified, are in mm

Imballo Minimo pcs  
Min. Packaging pcs

Imballo Standard pcs  
Std. Packaging pcs

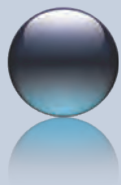

## DomusAir - Ventilazione residenziale

### DomusAir - Residential ventilation

#### Aspiratori assiali "MINI ELICAL" - IPX4

#### Axial fans IPX4 - "MINI ELICAL"

660

L'aspiratore assiale è la soluzione ideale per estrarre significativi volumi d'aria viziata direttamente all'esterno. Poiché genera una bassa pressione, esso deve essere collegato ad un condotto di diametro appropriato e di lunghezza minore a 1,5m.

Un'installazione errata può compromettere il corretto funzionamento e/o il rendimento dell'aspiratore.

The axial fan is the ideal solution to extract significant volumes of stale air directly outside. Since it generates limited pressure, it must be connected to the appropriate diameter duct less than 1,5m long.

Improper installation may result in an incorrect operation and/or decrease of the fan performance.



accessorio chiusura a farfalla  
back-draught shutter accessory

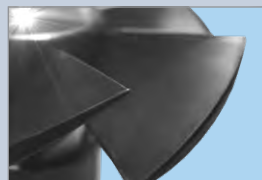

ventola con pale a "winglet"  
winglet-type impeller

#### Prestazioni Performance

Codice Code	Modello Model	Portata Air flow m³/h max	Alimentazione Power supply V~	Consumo Power W max	Pressione sonora Sound Pressure dB(A) @3m	Temp.ambiente Ambient temp. °C max	Marcatura Marking
VNB100	MINI ELICAL	72	220-240 50/60Hz	8	26	50	CE
VNB100T	MINI ELICAL	72	220-240 50/60Hz	8	26	50	CE
VNB150	MINI ELICAL	250	220-240 50/60Hz	22	39	50	CE
VNB150T	MINI ELICAL	250	220-240 50/60Hz	22	39	50	CE

- Note/Notes:**
- ✓ prestazioni aeruliche misurate secondo ISO 5801 a 230V 50Hz, densità dell'aria 1,2 Kg/m³  
air performance measured according to ISO 5801 at 230V 50Hz, air density 1,2 Kg/m³
  - ✓ dati misurati in laboratorio accreditato TÜV Rheinland  
data measured in TÜV Rheinland accredited laboratory

#### Dimensioni (mm) Dimensions (mm)

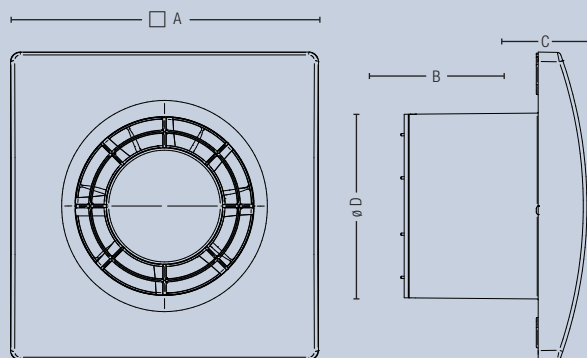

Codice Code	A	B	C	ØD
VNB100 - VNB100T	140	67	23	99
VNB150 - VNB150T	184	96	30	148

#### Comandi e sensori ambiente Controls and ambient sensors



Regolatore velocità  
Speed controller  
441048M (Domus)



Timer  
Timer  
441021 (Domus)



Igrostato  
Hygrostat  
441079 (Domus)  
442079 (Life)  
443079 (Allumia)  
445079 (Tekla)  
449079 (Class)



Rilevatore PIR  
PIR sensor  
441068RL (Domus)  
442068RL (Life)  
443068RL (Allumia)  
445068RL (Tekla)  
446068RL (Whitek)  
449068RL (Class)











Per la disponibilità contattare la rete commerciale  
For availability please contact sales dept.



Disponibilità fino ad esaurimento scorte  
Available until stock out



**Aspiratori assiali "MINI ELICAL" - IPX4**  
Axial fans IPX4 - "MINI ELICAL"

		Descrizione <i>Description</i>	Info	€	□	□	661
 <p>VNB100 VNB100T</p> 		<p><b>VNB100</b> Aspiratore assiale Ø100mm - motore con bronzine - portata massima 72 m<sup>3</sup>/h - per installazione in bagno, toilette e piccoli ambienti. Versione base. <i>Axial fan Ø100mm - sleeve bearing motor - max air flow 72 m<sup>3</sup>/h - for installation in bathrooms, toilets and small living areas.</i> <i>Basic version.</i></p>		43,94	1	1	
		<p><b>VNB100T</b> Aspiratore assiale Ø100mm - motore con bronzine - portata massima 72 m<sup>3</sup>/h - per installazione in bagno, toilette e piccoli ambienti. Versione con timer. <i>Axial fan Ø100mm - sleeve bearing motor - max air flow 72 m<sup>3</sup>/h - for installation in bathrooms, toilets and small living areas.</i> <i>Timer version.</i></p>		71,13	1	1	
 <p>VNB150 VNB150T</p> 		<p><b>VNB150</b> Aspiratore assiale Ø150mm - motore con bronzine - portata massima 250 m<sup>3</sup>/h - per installazione in bagno, toilette e medi ambienti. Versione base. <i>Axial fan Ø150mm - sleeve bearing motor - max air flow 250 m<sup>3</sup>/h - for installation in bathrooms, toilets and medium living areas.</i> <i>Basic version.</i></p>		61,61	1	1	
		<p><b>VNB150T</b> Aspiratore assiale Ø150mm - motore con bronzine - portata massima 250 m<sup>3</sup>/h - per installazione in bagno, toilette e medi ambienti. Versione con timer. <i>Axial fan Ø150mm - sleeve bearing motor - max air flow 250 m<sup>3</sup>/h - for installation in bathrooms, toilets and medium living areas.</i> <i>Timer version.</i></p>		83,25	1	1	

**Installazione *Installation***

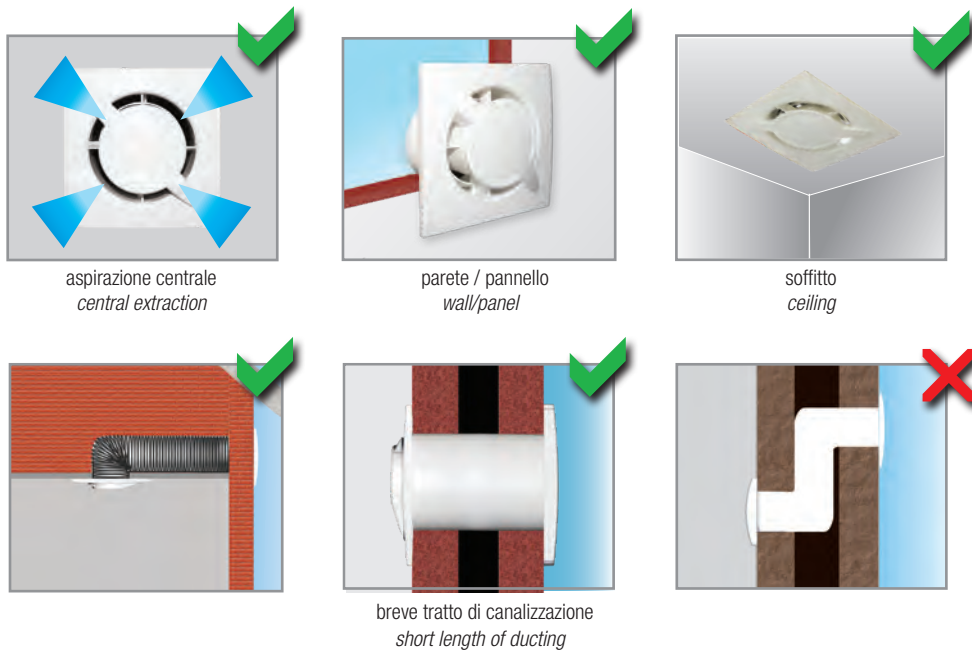



# DomusAir - Ventilazione residenziale

## DomusAir - Residential ventilation

Aspiratori assiali "GRID" - IPX4

Axial fans IPX4 - "GRID"

662

Descrizione Description

Info

€

□

□



VNA90  
VNA90T



### VNA90

Aspiratore assiale Ø90mm - alette interne automatiche - motore con cuscinetti a sfera (long life) - portata massima 55 m³/h - per installazione in bagno, toilette e piccoli ambienti. Versione base.

*Axial fan Ø90mm - internal automatic shutters - ball bearing motor (long life) - max air flow 55 m³/h - for installation in bathroom, toilet and small living areas Basic version*



91,40 1 1

### VNA90T

Aspiratore assiale Ø90mm - alette interne automatiche - motore con cuscinetti a sfera (long life) - portata massima 55 m³/h - per installazione in bagno, toilette e piccoli ambienti. Versione con timer.

*Axial fan Ø90mm - internal automatic shutters - ball bearing motor (long life) - max air flow 55 m³/h - for installation in bathrooms, toilets and small living areas. Timer version.*



110,28 1 1

### VNA100

Aspiratore assiale Ø100mm - alette interne automatiche - motore con cuscinetti a sfera (long life) - portata massima 83 m³/h - per installazione in bagno, toilette e piccoli ambienti. Versione base.

*Axial fan Ø100mm - internal automatic shutters - ball bearing motor (long life) - max air flow 83 m³/h - for installation in bathroom, toilet and small living areas Basic version*



104,64 1 1

### VNA100T

Aspiratore assiale Ø100mm - alette interne automatiche - motore con cuscinetti a sfera (long life) - portata massima 83 m³/h - per installazione in bagno, toilette e piccoli ambienti. Versione con timer.

*Axial fan Ø100mm - internal automatic shutters - ball bearing motor (long life) - max air flow 83 m³/h - for installation in bathrooms, toilets and small living areas. Timer version.*



128,68 1 1



VNA100  
VNA100T  
VNA100HT



### VNA100HT

Aspiratore assiale Ø100mm - alette interne automatiche - motore con cuscinetti a sfera (long life) - portata massima 83 m³/h - per installazione in bagno, toilette e piccoli ambienti. Versione con umidostato & timer.

*Axial fan Ø100mm - internal automatic shutters - ball bearing motor (long life) - max air flow 83 m³/h - for installation in bathrooms, toilets and small living areas. Humidistat & timer version.*



190,07 1 1

### VNA120

Aspiratore assiale Ø120mm - alette interne automatiche - motore con cuscinetti a sfera (long life) - portata massima 151 m³/h - per installazione in bagno, toilette e piccoli/medi ambienti. Versione base.

*Axial fan Ø120mm - internal automatic shutters - ball bearing motor (long life) - max air flow 151 m³/h - for installation in bathrooms, toilets and small/medium living areas. Basic version.*



134,36 1 1

### VNA120T

Aspiratore assiale Ø120mm - alette interne automatiche - motore con cuscinetti a sfera (long life) - portata massima 151 m³/h - per installazione in bagno, toilette e piccoli/medi ambienti. Versione con timer.

*Axial fan Ø120mm - internal automatic shutters - ball bearing motor (long life) - max air flow 151 m³/h - for installation in bathrooms, toilets and small/medium living areas. Timer version.*



172,20 1 1



VNA120  
VNA120T  
VNA120HT



### VNA120HT

Aspiratore assiale Ø120mm - alette interne automatiche - motore con cuscinetti a sfera (long life) - portata massima 151 m³/h - per installazione in bagno, toilette e piccoli/medi ambienti. Versione con umidostato & timer.

*Axial fan Ø120mm - internal automatic shutters - ball bearing motor (long life) - max air flow 151 m³/h - for installation in bathrooms, toilets and small/medium living areas. Humidistat & timer version.*



191,43 1 1



Per la disponibilità contattare la rete commerciale  
For availability please contact sales dept.



Disponibilità fino ad esaurimento scorte  
Available until stock out

**Aspiratori assiali "GRID" - IPX4**  
**Axial fans IPX4 - "GRID"**



VNA150  
 VNA150T  
 VNA150HT



**Descrizione** *Description*

**Info**

€

□

□

663

**VNA150**

Aspiratore assiale Ø150mm - alette interne automatiche - motore con cuscinetti a sfera (long life) - portata massima 320 m³/h - per installazione in bagno, toilette e medi ambienti. Versione base.

*Axial fan Ø150mm - internal automatic shutters - ball bearing motor (long life) - max air flow 320 m³/h - for installation in bathrooms, toilets and medium living areas. Basic version.*



191,33 1 1

**VNA150T**

Aspiratore assiale Ø150mm - alette interne automatiche - motore con cuscinetti a sfera (long life) - portata massima 320 m³/h - per installazione in bagno, toilette e medi ambienti. Versione con timer.

*Axial fan Ø150mm - internal automatic shutters - ball bearing motor (long life) - max air flow 320 m³/h - for installation in bathrooms, toilets and medium living areas. Timer version.*



204,46 1 1

**VNA150HT**

Aspiratore assiale Ø150mm - alette interne automatiche - motore con cuscinetti a sfera (long life) - portata massima 320 m³/h - per installazione in bagno, toilette e medi ambienti.

Versione con umidostato & timer.

*Axial fan Ø150mm - internal automatic shutters - ball bearing motor (long life) - max air flow 320 m³/h - for installation in bathrooms, toilets and medium living areas. Humidistat & timer version.*



252,44 1 1

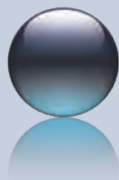

## DomusAir - Ventilazione residenziale

### DomusAir - Residential ventilation

#### Aspiratori assiali "GRID" - IPX4

#### Axial fans IPX4 - "GRID"

664

L'aspiratore assiale è la soluzione ideale per estrarre significativi volumi d'aria viziata direttamente all'esterno. Poiché genera una bassa pressione, esso deve essere collegato ad un condotto di diametro appropriato e di lunghezza minore a 1,5m.

Un'installazione errata può compromettere il corretto funzionamento e/o il rendimento dell'aspiratore.

*The axial fan is the ideal solution to extract significant volumes of stale air directly outside. Since it generates limited pressure, it must be connected to the appropriate diameter duct less than 1,5m long. Improper installation may result in an incorrect operation and/or decrease of the fan performance.*



chiusura precisa delle alette  
tight closing of the shutters

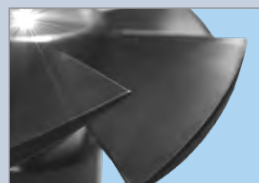

ventola con pale a "winglet"  
winglet-type impeller

## Caratteristiche Tecniche Technical Features

#### Prestazioni Performance

Codice Code	Modello Model	Portata Air flow m <sup>3</sup> /h max	Pressione statica Static pressure Pa max	Alimentazione Power supply V~	Consumo Power W max	Pressione sonora Sound Pressure dB(A) @3m	Temp.ambiente Ambient temp. °C max	Marcatura Marking
VNA90	GRID	55	17	220-240 50/60Hz	11	33	50	CE
VNA90T	GRID	55	17	220-240 50/60Hz	11	33	50	CE
VNA100	GRID	83	27	220-240 50/60Hz	11	33	50	CE
VNA100T	GRID	83	27	220-240 50/60Hz	11	33	50	CE
VNA100HT	GRID	83	27	220-240 50/60Hz	11	33	50	CE
VNA120	GRID	151	40	220-240 50/60Hz	16	38	50	CE
VNA120T	GRID	151	40	220-240 50/60Hz	16	38	50	CE
VNA120HT	GRID	151	40	220-240 50/60Hz	16	38	50	CE
VNA150	GRID	320	59	220-240 50/60Hz	26	43	50	CE
VNA150T	GRID	320	59	220-240 50/60Hz	26	43	50	CE
VNA150HT	GRID	320	59	220-240 50/60Hz	26	43	50	CE

- Note/Notes:**
- ✓ prestazioni aerauliche misurate secondo ISO 5801 a 230V 50Hz, densità dell'aria 1,2 Kg/m<sup>3</sup>  
*air performance measured according to ISO 5801 at 230V 50Hz, air density 1,2 Kg/m<sup>3</sup>*
  - ✓ dati misurati in laboratorio accreditato TÜV Rheinland  
*data measured in TÜV Rheinland accredited laboratory*



Per la disponibilità contattare la rete commerciale  
For availability please contact sales dept.



Disponibilità fino ad esaurimento scorte  
Available until stock out

## Aspiratori assiali "GRID" - IPX4 Axial fans IPX4 - "GRID"

665

### Dimensioni (in mm) Dimensions (mm)

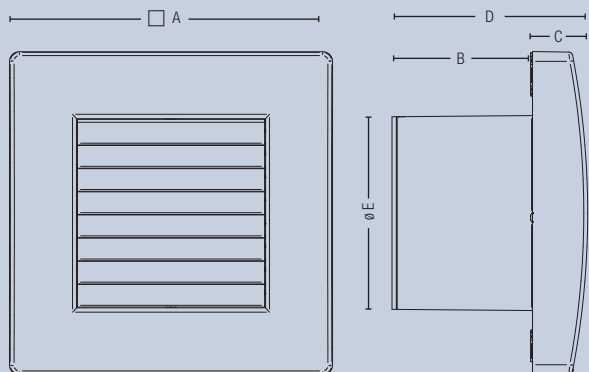

Codice Code	A	B	C	D	ØE
VNA90 - VNA90T	164	55	29	84	90
VNA100 - VNA100T - VNA100HT	164	70	29	99	99
VNA120 - VNA120T - VNA120HT	184	81	30	111	119
VNA150 - VNA150T - VNA150HT	218	97	32	129	148

### Installazione Installation

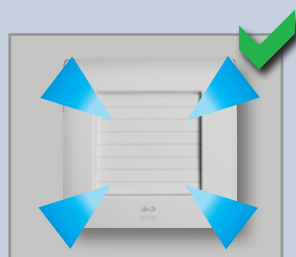

aspirazione centrale  
central extraction



parete / pannello  
wall/panel



soffitto (accessorio a richiesta)  
ceiling (accessory on request)

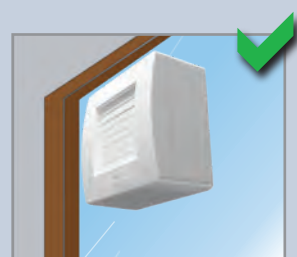

finestra (accessorio a richiesta)  
window (accessory on request)

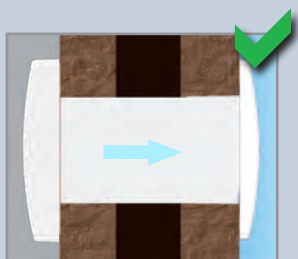
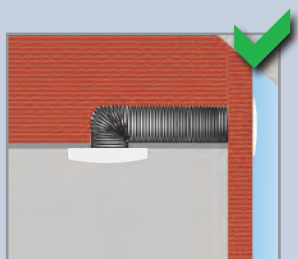

breve tratto di canalizzazione  
short length of ducting

### Comandi e sensori ambiente Controls and ambient sensors



Regolatore velocità  
Speed controller  
441048M (Domus)



Timer  
Timer  
441021 (Domus)



Igrostato  
Hygrostat  
441079 (Domus)  
442079 (Life)  
443079 (Allumia)  
445079 (Tekla)  
449079 (Class)



Rilevatore PIR  
PIR sensor  
441068RL (Domus)  
442068RL (Life)  
443068RL (Allumia)  
445068RL (Tekla)  
446068RL (Whitek)  
449068RL (Class)

Le dimensioni, salvo diversamente specificato, sono in mm  
Dimensions, except where otherwise specified, are in mm

Imballo Minimo pcs  
Min. Packaging pcs

Imballo Standard pcs  
Std. Packaging pcs



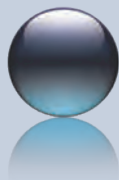

## DomusAir - Ventilazione residenziale

### DomusAir - Residential ventilation

#### Aspiratori assiali "FLUCSO" - IPX4

#### Axial fans IPX4 - "FLUCSO"

666

L'aspiratore assiale è la soluzione ideale per estrarre significativi volumi d'aria viziata direttamente all'esterno. Poiché genera una bassa pressione, esso deve essere collegato ad un condotto di diametro appropriato e di lunghezza minore a 1,5m.

Un'installazione errata può compromettere il corretto funzionamento e/o il rendimento dell'aspiratore.

*The axial fan is the ideal solution to extract significant volumes of stale air directly outside. Since it generates limited pressure, it must be connected to the appropriate diameter duct less than 1,5 long.*

*Improper installation may result in an incorrect operation and/or decrease of the fan performance.*



deflettori aerodinamici  
aerodynamic deflectors

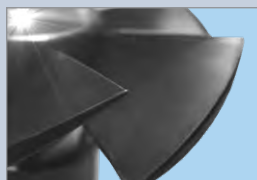

ventola con pale a "winglet"  
winglet-type impeller

#### Prestazioni Performance

Codice Code	Modello Model	Portata Air flow m <sup>3</sup> /h max	Pressione statica Static pressure Pa max	Alimentazione Power supply V~	Consumo Power W max	Pressione sonora Sound Pressure dB(A) @3m	Temp.ambiente Ambient temp. °C max	Marcatura Marking
VNT100	FLUCSO	84	24	220-240 50/60Hz	8	34	50	CE
VNT100T	FLUCSO	84	24	220-240 50/60Hz	8	34	50	CE
VNT120	FLUCSO	163	43	220-240 50/60Hz	14	40	50	CE
VNT120T	FLUCSO	163	43	220-240 50/60Hz	14	40	50	CE
VNT150	FLUCSO	312	57	220-240 50/60Hz	24	46	50	CE

- Note/Notes:**
- ✓ prestazioni aerauliche misurate secondo ISO 5801 a 230V 50Hz, densità dell'aria 1,2 Kg/m<sup>3</sup>  
*air performance measured according to ISO 5801 at 230V 50Hz, air density 1,2 Kg/m<sup>3</sup>*
  - ✓ dati misurati in laboratorio accreditato TÜV Rheinland  
*data measured in TÜV Rheinland accredited laboratory*

#### Dimensioni (mm) Dimensions (mm)

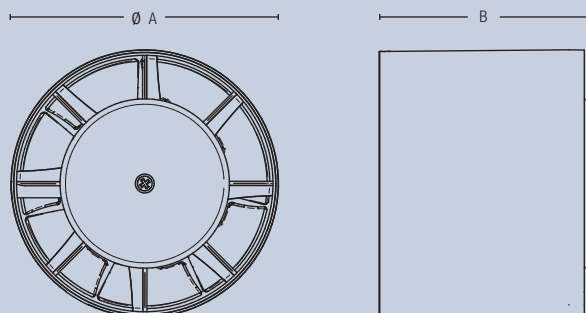

Codice Code	ØA	B
VNT100 - VNT100T	99	80
VNT120 - VNT120T	119	90
VNT150	148	100



Per la disponibilità contattare la rete commerciale  
For availability please contact sales dept.



Disponibilità fino ad esaurimento scorte  
Available until stock out

**Aspiratori assiali "FLUCSO" - IPX4**  
Axial fans IPX4 - "FLUCSO"

		Descrizione <i>Description</i>	Info	€	<input type="checkbox"/>	<input type="checkbox"/>	667
	VNT100	<b>VNT100</b> Aspiratore assiale Ø100mm - motore con bronzine - montaggio in linea con i tubi - portata massima 84 m³/h - per installazione in bagno, toilette e piccoli ambienti. Versione base. <i>Axial fan Ø100mm - sleeve bearing motor - in-line duct mounting - max air flow 84 m³/h - for installation in bathrooms, toilets and small living areas. Basic version.</i>		44,31	1	1	
	VNT100T	<b>VNT100T</b> Aspiratore assiale Ø100mm - motore con bronzine - montaggio in linea con i tubi - portata massima 84 m³/h - per installazione in bagno, toilette e piccoli ambienti. Versione con timer. <i>Axial fan Ø100mm - sleeve bearing motor - in-line duct mounting - max air flow 84 m³/h - for installation in bathrooms, toilets and small living areas. Timer version.</i>		74,23	1	1	
	VNT120	<b>VNT120</b> Aspiratore assiale Ø120mm - motore con bronzine - montaggio in linea con i tubi - portata massima 163 m³/h - per installazione in bagno, toilette e piccoli/medi ambienti. Versione base. <i>Axial fan Ø120mm - sleeve bearing motor - in-line duct mounting - max air flow 163 m³/h - for installation in bathrooms, toilets and small/medium living areas. Basic version.</i>		57,88	1	1	
	VNT120T	<b>VNT120T</b> Aspiratore assiale Ø120mm - motore con bronzine - montaggio in linea con i tubi - portata massima 163 m³/h - per installazione in bagno, toilette e piccoli/medi ambienti. Versione con timer. <i>Axial fan Ø120mm - sleeve bearing motor - in-line duct mounting - max air flow 163 m³/h - for installation in bathrooms, toilets and small/medium living areas. Timer version.</i>		83,67	1	1	
	VNT150	<b>VNT150</b> Aspiratore assiale Ø150mm - motore con bronzine - montaggio in linea con i tubi - portata massima 312 m³/h - per installazione in bagno, toilette e medi ambienti. Versione base. <i>Axial fan Ø150mm - sleeve bearing motor - in-line duct mounting - max air flow 312 m³/h - for installation in bathrooms, toilets and medium living areas. Basic version.</i>		109,32	1	1	

**Installazione *Installation***

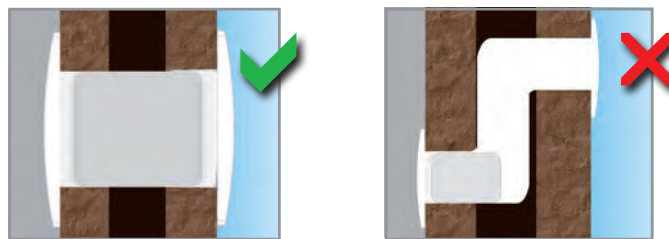

breve tratto di canalizzazione

**Comandi e sensori ambiente *Controls and ambient sensors***



**Regolatore velocità**  
*Speed controller*  
441048M (Domus)



**Timer**  
*Timer*  
441021 (Domus)



**Igrostato**  
*Hygrostat*  
441079 (Domus)  
442079 (Life)  
443079 (Allumia)  
445079 (Tekla)  
449079 (Class)



**Rilevatore PIR**  
*PIR sensor*  
441068RL (Domus)  
442068RL (Life)  
443068RL (Allumia)  
445068RL (Tekla)  
446068RL (Whitek)  
449068RL (Class)

Le dimensioni, salvo diversamente specificato, sono in mm  
Dimensions, except where otherwise specified, are in mm

Imballo Minimo pcs  
Min. Packaging pcs

Imballo Standard pcs  
Std. Packaging pcs

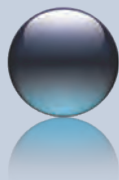

# DomusAir - Ventilazione residenziale

## DomusAir - Residential ventilation

### Aspiratori elicocentrifughi "SILENCE" - IP45 Mixed-flow fans IP45 - "SILENCE"

668

L'aspiratore elico-centrifugo è la soluzione ideale per estrarre significativi volumi d'aria viziata direttamente all'esterno o tramite condotti di media lunghezza. Un'installazione errata può compromettere il corretto funzionamento e/o il rendimento dell'aspiratore.

The mixed flow fan is the ideal solution to extract significant volumes of stale air directly outside through medium length ducting. Improper installation may result in an incorrect operation and/or decrease of the fan performance.



ogiva centrale aerodinamica  
aerodynamic-shaped inlet



accessorio chiusura a farfalla  
back-draught shutter accessory

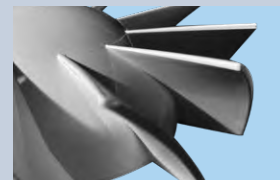

ventola con pale a "winglet"  
winglet-type impeller

#### Prestazioni Performance

Codice Code	Modello Model	Portata Air flow m³/h max	Pressione statica Static pressure Pa max	Alimentazione Power supply V~	Consumo Power W max	Pressione sonora Sound Pressure dB(A) @3m	Temp.ambiente Ambient temp. °C max	Marcatura Marking
VNSS100B	SILENCE	95	47	220-240 50/60Hz	8	25	50	CE
VNSS1002V	SILENCE	105/70	53/22	220-240 50/60Hz	8/5	26/22	50	CE

**Note/Notes:** ✓ prestazioni aerauliche misurate secondo ISO 5801 a 230V 50Hz, densità dell'aria 1,2 Kg/m³  
air performance measured according to ISO 5801 at 230V 50Hz, air density 1,2 Kg/m³  
✓ dati misurati in laboratorio accreditato TÜV Rheinland  
data measured in TÜV Rheinland accredited laboratory

#### Dimensioni (mm) Dimensions (mm)

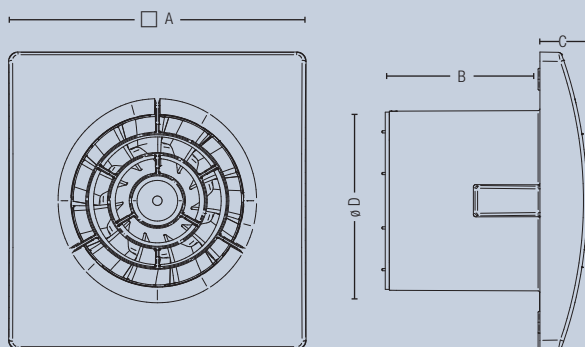

Codice Code	A	B	C	ØD
VNSS100B - VNSS1002V	164	84	27	99,4

#### Comandi e sensori ambiente Controls and ambient sensors



Regolatore velocità  
Speed controller  
441048M (Domus)



Timer  
Timer  
441021 (Domus)



Igrostato  
Hygrostat  
441079 (Domus)  
442079 (Life)  
443079 (Allumia)  
445079 (Tekla)  
449079 (Class)



Rilevatore PIR  
PIR sensor  
441068RL (Domus)  
442068RL (Life)  
443068RL (Allumia)  
445068RL (Tekla)  
446068RL (Whitek)  
449068RL (Class)











Per la disponibilità contattare la rete commerciale  
For availability please contact sales dept.



Disponibilità fino ad esaurimento scorte  
Available until stock out

**Aspiratori elicocentrifughi "SILENCE" - IP45**  
**Mixed-flow fans IP45 - "SILENCE"**

	Descrizione <i>Description</i>	Info	€	□	□	669
 <p>VNSS100B</p>  	<p><b>VNSS100B</b>                      Aspiratore elicocentrifugo Ø100mm - alte prestazioni - motore con bronzine - portata massima 95 m³/h - per installazione in bagno, toilette e medi ambienti.                      Versione base.  <i>Mixed-flow fan Ø100mm - high performance - sleeve bearing motor - max air flow 95 m³/h - for installation in bathrooms, toilets and medium living areas. Basic version.</i></p>		<p>75,97</p>	1	1	
 <p>VNSS1002V</p>   	<p><b>VNSS1002V</b>                      Aspiratore elicocentrifugo Ø100mm - alte prestazioni - motore con cuscinetti a sfera (long life) - portata massima 105 m³/h - per installazione in bagno, toilette e medi ambienti.                      Versione a 2 velocità.  <i>Mixed-flow fan Ø100mm - high performance - ball bearing motor - max air flow 105 m³/h - for installation in bathrooms, toilets and medium living areas. 2 speed version.</i></p>		<p>114,10</p>	1	1	

**Installazione *Installation***

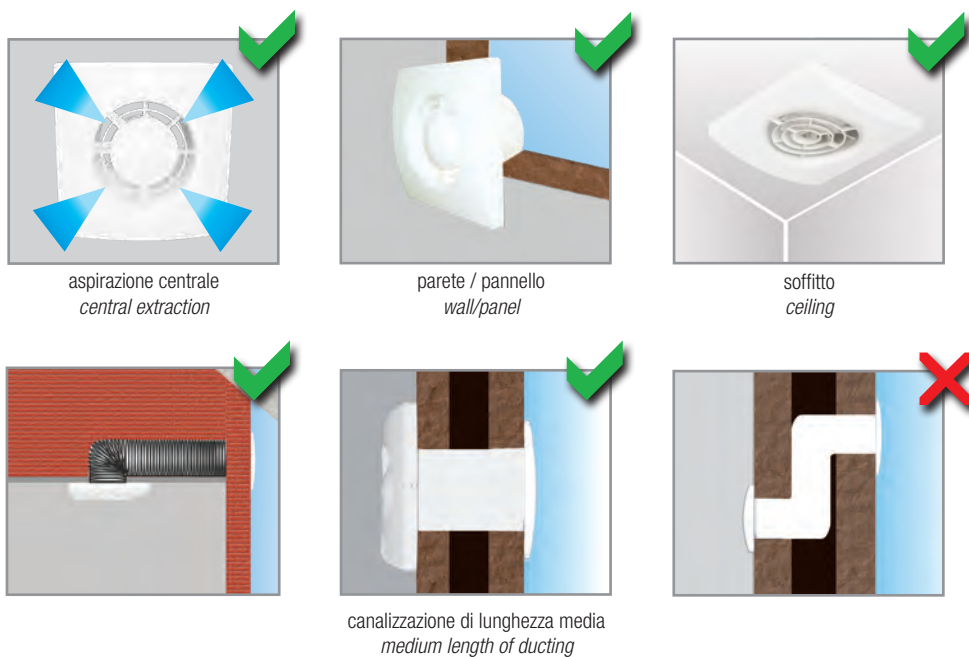

VENTILAZIONE  
 VENTILATION

Le dimensioni, salvo diversamente specificato, sono in mm  
 Dimensions, except where otherwise specified, are in mm

Imballo Minimo pcs  
 Min. Packaging pcs

Imballo Standard pcs  
 Std. Packaging pcs

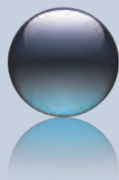

# DomusAir - Ventilazione residenziale

## DomusAir - Residential ventilation

### Aspiratori centrifughi "FLOo" - IPX4

### Centrifugal fans IPX4 - "FLOo"

670

L'aspiratore centrifugo genera un'elevata pressione che permette di estrarre l'aria viziata anche attraverso lunghe canallizzazioni. Un'installazione errata può compromettere il corretto funzionamento e/o il rendimento dell'aspiratore.

The centrifugal fan generates high pressure in order to overcome the resistance of long ducting system. Improper installation may result in an incorrect operation and/or decrease of the fan performance.

griglia interna aerodinamica  
aerodynamic internal grille



filtro interno rimovibile  
removable internal filter

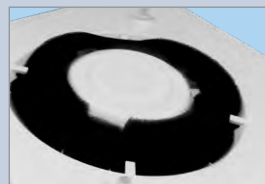

#### Prestazioni Performance

Codice Code	Modello Model	Portata Air flow m³/h max	Pressione statica Static pressure Pa max	Alimentazione Power supply V~	Consumo Power W max	Pressione sonora Sound Pressure dB(A) @3m	Temp.ambiente Ambient temp. °C max	Marcatura Marking
VNDC80	FLOo	104/62	251/142	220-240 50/60Hz	28/17	38/27	50	CE
VNDC80T	FLOo	104/62	251/142	220-240 50/60Hz	28/17	38/27	50	CE
VNDC80HT	FLOo	104/62	251/142	220-240 50/60Hz	28/17	38/27	50	CE
VNDC100	FLOo	104/62	251/142	220-240 50/60Hz	28/17	38/27	50	CE
VNDC100T	FLOo	104/62	251/142	220-240 50/60Hz	28/17	38/27	50	CE
VNDC100HT	FLOo	104/62	251/142	220-240 50/60Hz	28/17	38/27	50	CE

**Note/Notes:** ✓ prestazioni aerauliche misurate secondo ISO 5801 a 230V 50Hz, densità dell'aria 1,2 Kg/m³  
air performance measured according to ISO 5801 at 230V 50Hz, air density 1,2 Kg/m³  
✓ dati misurati in laboratorio accreditato TÜV Rheinland  
data measured in TÜV Rheinland accredited laboratory

#### Dimensioni (mm) Dimensions (mm)

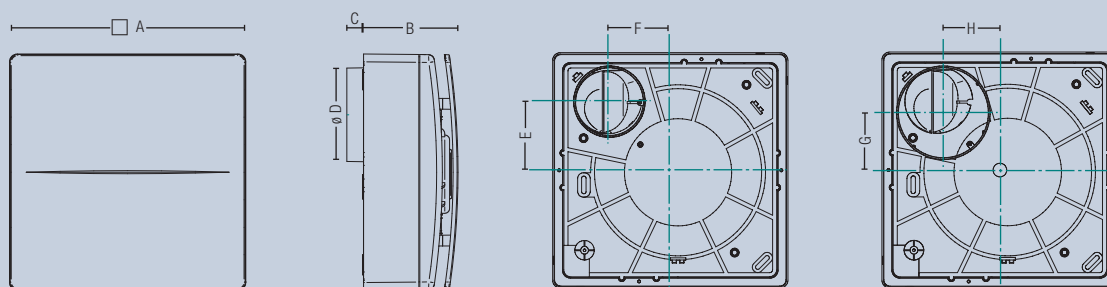

Codice Code	A	B	C	ØD	E	F	G	H
VNDC80 - VNDC80T - VNDC80HT	241,5	96,5	17	73,5	70,5	62,5	-	-
VNDC100 - VNDC100T - VNDC100HT	241,5	96,5	17	96	-	-	59	58

#### Comandi e sensori ambiente Controls and ambient sensors



Regolatore velocità  
Speed controller  
441048M (Domus)



Timer  
Timer  
441021 (Domus)



Igrostato  
Hygrostat  
441079 (Domus)  
442079 (Life)  
443079 (Allumia)  
445079 (Tekla)  
449079 (Class)



Rilevatore PIR  
PIR sensor  
441068RL (Domus)  
442068RL (Life)  
443068RL (Allumia)  
445068RL (Tekla)  
446068RL (Whitek)  
449068RL (Class)



Per la disponibilità contattare la rete commerciale  
For availability please contact sales dept.













Disponibilità fino ad esaurimento scorte  
Available until stock out

Caratteristiche Tecniche Technical Features



## Aspiratori centrifughi "FLOo" - IPX4 Centrifugal fans IPX4 - "FLOo"

Descrizione Description		Info	€	□	□	671
 <p>VNDC80 VNDC80T VNDC80HT</p>  	<p><b>VNDC80</b> Aspiratore centrifugo compatto Ø80mm - motore con cuscinetti a sfera - portata massima 104 m³/h - per installazione in bagno, toilette, cucine e piccoli/medi ambienti - montaggio a superficie o ad incasso. Versione base. <i>Compact centrifugal duct fan Ø80mm - ball bearing motor - max air flow 104 m³/h - for installation in bathrooms, toilets, kitchens and small/medium living areas - surface or flush mounting. Basic version.</i></p>		149,06	1	1	
	<p><b>VNDC80T</b> Aspiratore centrifugo compatto Ø80mm - motore con cuscinetti a sfera - portata massima 104 m³/h - per installazione in bagno, toilette, cucine e piccoli/medi ambienti - montaggio a superficie o ad incasso. Versione con timer. <i>Compact centrifugal duct fan Ø80mm - ball bearing motor - max air flow 104 m³/h - for installation in bathrooms, toilets, kitchens and small/medium living areas - surface or flush mounting. Timer version.</i></p>		199,43	1	1	
	<p><b>VNDC80HT</b> Aspiratore centrifugo compatto Ø80mm - motore con cuscinetti a sfera - portata massima 104 m³/h - per installazione in bagno, toilette, cucine e piccoli/medi ambienti - montaggio a superficie o ad incasso. Versione con umidostato &amp; timer. <i>Compact centrifugal duct fan Ø80mm - ball bearing motor - max air flow 104 m³/h - for installation in bathrooms, toilets, kitchens and small/medium living areas - surface or flush mounting. Humidistat &amp; timer version.</i></p>		229,06	1	1	
 <p>VNDC100 VNDC100T VNDC100HT</p>  	<p><b>VNDC100</b> Aspiratore centrifugo compatto Ø100mm - motore con cuscinetti a sfera - portata massima 104 m³/h - per installazione in bagno, toilette, cucine e piccoli/medi ambienti. - montaggio a superficie o ad incasso. Versione base. <i>Compact centrifugal duct fan Ø100mm - ball bearing motor - max air flow 104 m³/h - for installation in bathrooms, toilets, kitchens and small/medium living areas - surface or flush mounting. Basic version.</i></p>		149,87	1	1	
	<p><b>VNDC100T</b> Aspiratore centrifugo compatto Ø100mm - motore con cuscinetti a sfera - portata massima 104 m³/h - per installazione in bagno, toilette, cucine e piccoli/medi ambienti - montaggio a superficie o ad incasso. Versione con timer. <i>Compact centrifugal duct fan Ø100mm - ball bearing motor - max air flow 104 m³/h - for installation in bathrooms, toilets, kitchens and small/medium living areas - surface or flush mounting. Timer version.</i></p>		211,78	1	1	
	<p><b>VNDC100HT</b> Aspiratore centrifugo compatto Ø100mm - motore con cuscinetti a sfera - portata massima 104 m³/h - per installazione in bagno, toilette, cucine e piccoli/medi ambienti - montaggio a superficie o ad incasso. Versione con umidostato &amp; timer. <i>Compact centrifugal duct fan Ø100mm - ball bearing motor - max air flow 104 m³/h - for installation in bathrooms, toilets, kitchens and small/medium living areas - surface or flush mounting. Humidistat &amp; timer version.</i></p>		238,24	1	1	
 <p>VNKCGVNDK</p>	<p><b>VNKCGVNDK</b> Kit per montaggio ad incasso in strutture in cartongesso per aspiratori centrifughi della gamma VNDC. <i>Kit for installation in hollow walls for centrifugal fans range VNDC.</i></p>		11,86	1	1	

### Installazione Installation

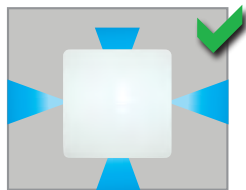

aspirazione perimetrale  
perimetral extraction



a superficie - parete/pannello  
surface - wall/panel



a incasso - pannello  
flush - panel

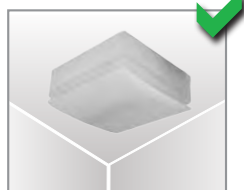

a superficie - soffitto  
surface - ceiling

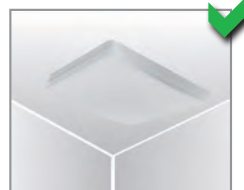

a incasso - soffitto  
flush - ceiling

Le dimensioni, salvo diversamente specificato, sono in mm  
Dimensions, except where otherwise specified, are in mm

Imballo Minimo pcs  
Min. Packaging pcs

Imballo Standard pcs  
Std. Packaging pcs



# DomusAir - Ventilazione residenziale

## DomusAir - Residential ventilation

Accessori per aspiratori assiali gamma: Axial, Elical Top, Elical e Grid - Kit Vetro  
Accessories for axial fans ranges: Axial, Elical Top, Elical and Grid - Window Kit

672



VNSEV100  
VNSEV120  
VNSEV150



VNGEV100  
VNGEV120  
VNGEV150

### Descrizione Description

Info

€

□

□

**VNSEV100**  
Kit vetro Ø100mm con serranda a gravità esterna.  
Window kit Ø100mm with external gravity shutters.

27,44 1 1

**VNSEV120**  
Kit vetro Ø120mm con serranda a gravità esterna.  
Window kit Ø120mm with external gravity shutters.

32,30 1 1

**VNSEV150**  
Kit vetro Ø150mm con serranda a gravità esterna.  
Window kit Ø150mm with external gravity shutters.

36,54 1 1

**VNGEV100**  
Kit vetro Ø100mm con griglia fissa esterna.  
Window kit Ø100mm with external fixed grille.

27,71 1 1

**VNGEV120**  
Kit vetro Ø120mm con griglia fissa esterna.  
Window kit Ø120mm with external fixed grille.

30,76 1 1

**VNGEV150**  
Kit vetro Ø150mm con griglia fissa esterna.  
Window kit Ø150mm with external fixed grille.

32,62 1 1

## Accessori per aspiratori assiali e centrifughi- Griglie e Serrande Accessories for axial and centrifugal fans - Grilles and Shutters

### Descrizione Description

Info

€

□

□



VNSE100  
VNSE120  
VNSE150

**VNSE100**  
Serranda a gravità esterna Ø100mm.  
External gravity shutter Ø100mm.

14,48 4 4

**VNSE120**  
Serranda a gravità esterna Ø120mm.  
External gravity shutter Ø120mm.

14,48 4 4

**VNSE150**  
Serranda a gravità esterna Ø150mm.  
External gravity shutter Ø150mm.

16,02 4 4



VNGE100  
VNGE120  
VNGE150

**VNGE100**  
Griglia fissa esterna Ø100mm.  
External fixed grille Ø100mm.

11,40 4 4

**VNGE120**  
Griglia fissa esterna Ø120mm.  
External fixed grille Ø120mm.

11,40 4 4

**VNGE150**  
Griglia fissa esterna Ø150mm.  
External fixed grille Ø150mm.

13,08 4 4

### Dimensioni (in mm) Dimensions (mm)

VNSE100 - 120 - 150

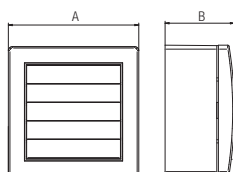

Codice Code	A	B	foro vetro glass hole
VNSEV100	164	87	Ø115
VNSEV120	184	100	Ø135
VNSEV150	218	117	Ø172

spessore vetro da 2 a 35mm  
glass thickness from 2 to 35mm

VNSE100 - 120 - 150

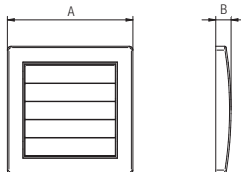

Codice Code	A	B
VNSE100	164	20
VNSE120	184	20
VNSE150	218	20

VNGEV100 - 120 - 150

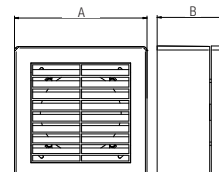

Codice Code	A	B	foro vetro glass hole
VNGEV100	164	87	Ø115
VNGEV120	184	100	Ø135
VNGEV150	218	117	Ø172

spessore vetro da 2 a 35mm  
glass thickness from 2 to 35mm

VNGE100 - 120 - 150

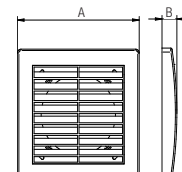

Codice Code	A	B
VNGE100	164	20
VNGE120	184	20
VNGE150	218	20



Per la disponibilità contattare la rete commerciale  
For availability please contact sales dept.



Disponibilità fino ad esaurimento scorte  
Available until stock out

## Accessori per aspiratori assiali e centrifughi - Guarnizioni Accessories for axial and centrifugal fans - Gaskets

		Descrizione Description	Info	€	<input type="checkbox"/>	<input type="checkbox"/>	673
	VNGS100	Guarnizione Ø100mm per installazione a soffitto di aspiratori assiali. Gasket Ø100mm for ceiling installation of axial fans.		10,18	1	1	
	VNGS120	Guarnizione Ø120mm per installazione a soffitto di aspiratori assiali. Gasket Ø120mm for ceiling installation of axial fans.		10,18	1	1	
	VNGS150	Guarnizione Ø150mm per installazione a soffitto di aspiratori assiali. Gasket Ø150mm for ceiling installation of axial fans.		10,91	1	1	
	VNGSC80/100	Guarnizione Ø80-100mm per installazione a soffitto di aspiratori centrifughi. Gasket Ø80-100mm for ceiling installation of centrifugal fans.		11,04	1	1	

## Accessori per aspiratori assiali - Chiusure a farfalla Accessories for axial fans - Back draught shutters

		Descrizione Description	Info	€	<input type="checkbox"/>	<input type="checkbox"/>
	VNAM100	Chiusura a farfalla Ø100mm con aletta in mylar per prevenire il rientro dell'aria esterna a ventilatore spento. Back draught shutters Ø100mm with mylar flap to prevent air flowing back into the room when the fan is off.		4,16	4	4
	VNAM120	Chiusura a farfalla Ø120mm con aletta in mylar per prevenire il rientro dell'aria esterna a ventilatore spento. Back draught shutters Ø120mm with mylar flap to prevent air flowing back into the room when the fan is off.		4,26	4	4
	VNAM150	Chiusura a farfalla Ø150mm con aletta in mylar per prevenire il rientro dell'aria esterna a ventilatore spento. Back draught shutters Ø150mm with mylar flap to prevent air flowing back into the room when the fan is off.		4,57	4	4

## Accessori per aspiratori assiali - Staffa fissaggio Accessories for axial fans - Mounting foot

		Descrizione Description	Info	€	<input type="checkbox"/>	<input type="checkbox"/>
	V NFS100	Staffa di fissaggio per aspiratori "FLUCSO" Ø100mm Mounting foot for fans "FLUCSO" Ø100mm		9,93	4	4
	V NFS120	Staffa di fissaggio per aspiratori "FLUCSO" Ø120mm Mounting foot for fans "FLUCSO" Ø120mm		10,15	4	4
	V NFS150	Staffa di fissaggio per aspiratori "FLUCSO" Ø150mm Mounting foot for fans "FLUCSO" Ø150mm		10,50	4	4

### Dimensioni (in mm) Dimensions (mm)

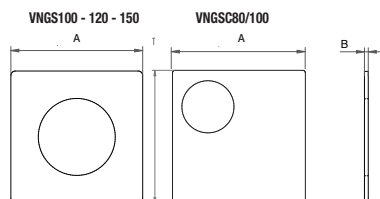

Codice Code	A	B
VNGS100	173	5
VNGS120	196	5
VNGS150	230	5
VNGSC80/100	255	5

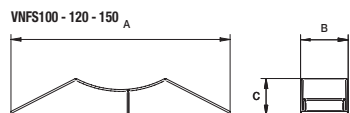

Codice Code	A	B	C
V NFS100	115	25	19
V NFS120	165	25	28
V NFS150	165	25	28

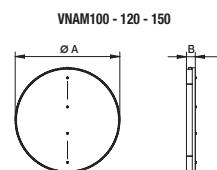

Codice Code	A	B
V NAM100	98	6,4
V NAM120	119	10
V NAM150	148	10

Le dimensioni, salvo diversamente specificato, sono in mm  
Dimensions, except where otherwise specified, are in mm

Imballo Minimo pcs  
Min. Packaging pcs

Imballo Standard pcs  
Std. Packaging pcs

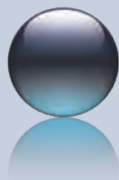

Scambiatore di calore rigenerativo con pacco ceramico lavabile  
*Heat exchanger regenerative type with ceramic core*

Base di supporto per facilitare le operazioni di manutenzione  
*Support base to facilitate maintenance operations*

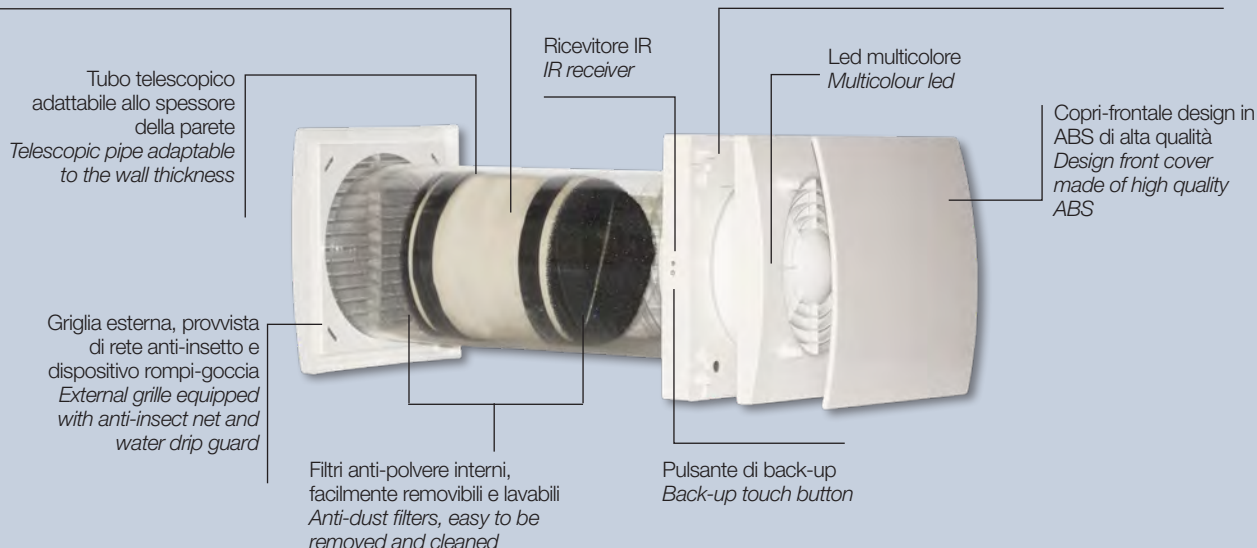

Portata alle varie velocità <i>Air flow at different speed</i>	m <sup>3</sup> /h	60/50/40/30/20
Assorbimento alle varie velocità <i>Power consumption at different speed</i>	W	6/4,5/3,5/2,5/2
Pressione sonora @ 3m <sup>(1)</sup> alle varie velocità <i>Sound pressure @ 3m<sup>(1)</sup> at different speed</i>	dB(A)	29/24/20/14/10
Efficienza termica <i>Thermal efficiency</i>	%	70/72/74/78/82
Temperatura ambiente <i>Ambient temperature</i>	°C	-20 ÷ +50
Grado di protezione IP <i>Degree of protection IP</i>	-	X4
Marchio <i>Mark</i>	-	<b>TÜV</b>

Note/Notes: ✓ prestazioni aerauliche misurate secondo ISO 5801 a 230V 50Hz, densità dell'aria 1,2 Kg/m<sup>3</sup>  
*air performance measured according to ISO 5801 at 230V 50Hz, air density 1,2 Kg/m<sup>3</sup>*

✓ dati misurati in laboratorio accreditato TÜV Rheinland  
*data measured in TÜV Rheinland accredited laboratory*

(1) livello di pressione sonora a 3m in campo libero, riportato solo a scopo comparativo.  
*sound pressure level at 3m in free field, reported for comparison purposes only.*

#### Funzionalità selezionabili tramite Telecomando *Functionalities selectable via IR remote control*

- direzione del flusso dell'aria (alternato, sola estrazione, sola immissione)  
*Air flow direction (alternate, extract only, intake only)*
- modalità free-cooling  
*free-cooling mode*
- velocità di funzionamento continuo (5 opzioni)  
*continuous speed (5 options)*
- posizione OFF  
*OFF position*
- velocità boost temporizzata  
*boost speed*
- modalità comfort o efficiency  
*comfort/efficiency mode*
- reset filtri  
*Filters reset*



#### Comandi e sensori ambiente *Controls and ambient sensors*



**Timer**  
*Timer*  
441021 (Domus)



**Igrostat**  
*Hygrostat*  
441079 (Domus) 445079 (Tekla)  
442079 (Life) 449079 (Class)  
443079 (Allumia)



**Rilevatore PIR**  
*PIR sensor*  
441068RL (Domus) 445068RL (Tekla)  
442068RL (Life) 446068RL (Whitek)  
443068RL (Allumia) 449068RL (Class)



**Modulo di comando manual**  
*Manual control panel*  
441001K3RC (Domus)  
442001K3RC (Life)



Per la disponibilità contattare la rete commerciale  
*For availability please contact sales dept.*



Disponibilità fino ad esaurimento scorte  
*Available until stock out*

## VMC decentralizzata "AXIAL" - IPX4 Decentralised CMV IPX4 - "AXIAL"

Descrizione Description		Info	€	<input type="checkbox"/>	<input type="checkbox"/>	675
 <b>VNDPS100</b>   	<b>VNDPS100</b> Unità di VMC decentralizzata Ø100 a singolo flusso continuo, a portata costante e bassissimo consumo energetico, per il ricambio d'aria in ambienti residenziali di piccole e medie dimensioni. Adatta per estrarre l'aria viziata verso l'esterno anche in presenza di condotti medio-lunghi. Installazione a parete, a soffitto e a finestra. <i>Ø100 decentralized CMV unit with single continuous flow, constant flow rate and very low energy consumption, for air exchange in small and medium-sized residential environments. Suitable for extracting stale air to the outside even in the presence of medium-long ducts. Wall, ceiling and window installation.</i>	 	259,31	1	1	

## VMC decentralizzata con recupero di calore "SOLITAIR" e "SOLAIR" - IPX4 Decentralised CMV heat recovery IPX4 - "SOLITAIR" and "SOLAIR"

Descrizione Description		Info	€	<input type="checkbox"/>	<input type="checkbox"/>	
 <b>VNRD100EC</b>   	<b>VNRD100EC</b> Unità ventilante decentralizzata a singolo flusso alternato con recupero di calore Ø108 mm - unità interna con frontale design - fino a 82% di efficienza termica - motore EC brushless a bassissimo consumo energetico, con cuscinetti a sfera (long life) - portata massima 25 m³/h - multi-velocità, per funzionamento continuo - per ambienti con superficie sino a 19 m² - per installazioni in ambienti nobili (stanze da letto e soggiorni) - SOLITAIR <i>Decentralised heat recovery unit with single alternate flow Ø108 mm - internal stylish front cover - up to 82% thermal efficiency - EC brushless motor for energy saving, provided with ball bearing (long life) - maximum rate 25 m³/h - multi-speed, for continuous running - for installation in noble premises like bedrooms and living rooms - for areas up to 19 m² - SOLITAIR</i>		477,73	1	1	
	 <b>VNRD150EC</b>   	<b>VNRD150EC</b> Unità ventilante decentralizzata a singolo flusso alternato con recupero di calore Ø158 mm - unità interna con frontale design - fino a oltre 82% di efficienza termica - motore EC brushless a bassissimo consumo energetico, con cuscinetti a sfera (long life) - portata massima 60 m³/h - multi-velocità, per funzionamento continuo - per ambienti con superficie sino a 45 m² - per installazione in ambienti nobili (stanze da letto e soggiorni) - SOLITAIR <i>Decentralised heat recovery unit with single alternate flow Ø158 mm - internal stylish front cover - up to 82% thermal efficiency - EC brushless motor for energy saving, provided with ball bearing (long life) - maximum rate 60 m³/h - multi-speed, for continuous running - for installation in noble premises like bedrooms and living rooms - for areas up to 45 m² - SOLITAIR</i>		617,61	1	1
 <b>VNRD150ECP</b>   		<b>VNRD150ECP</b> Unità ventilante decentralizzata a singolo flusso alternato con recupero di calore Ø158 mm - unità interna con frontale design - telecomando ad infrarossi fornito di serie - fino a 82% di efficienza termica - motore EC brushless a bassissimo consumo energetico, con cuscinetti a sfera (long life) - portata massima 60 m³/h - per funzionamento multivelocità reversibile e continuo - per ambienti con superficie sino a 45 m² - per installazioni in ambienti nobili (stanze da letto e soggiorni) - versione Plus - SOLITAIR <i>Decentralised heat recovery unit with single alternate flow Ø158 mm - internal stylish front cover - provided with infrared remote control - up to 82% thermal efficiency - EC brushless motor for energy saving, provided with ball bearing (long life) - maximum rate 60 m³/h - multi-speed, for continuous running - for areas up to 45 m² - for installation in noble premises like bedrooms and living rooms - Plus version - SOLITAIR</i>		685,85	1	1
	 <b>VNRP100EC</b>  	<b>VNRP100EC</b> Unità ventilante decentralizzata a doppio flusso con recupero di calore per installazione su pareti perimetrali - fino a 87% di efficienza termica - motori EC brushless ad alto rendimento - portata massima 97 m³/h - comando integrato per controllo della velocità - per ambienti con superficie sino a 75 m² (es. aule scolastiche, sale d'attesa, appartamenti, ecc.) - SOLAIR <i>Decentralised ventilation unit with heat recovery for wall installation - up to 87% thermal efficiency - EC brushless energy saving motors - maximum rate 97 m³/h - integrated control for speed adjustment - for areas up to 75 m² (example school rooms, waiting rooms, apartments, etc.) - SOLAIR</i>		2313,10	1	1

VENTILAZIONE  
VENTILATION

Le dimensioni, salvo diversamente specificato, sono in mm  
Dimensions, except where otherwise specified, are in mm

Imballo Minimo pcs  
Min. Packaging pcs

Imballo Standard pcs  
Std. Packaging pcs



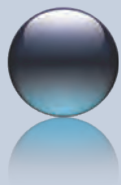

# DomusAir - Ventilazione residenziale

DomusAir - Residential ventilation

VNRL180ECPN

676

Caratteristiche Tecniche Technical Features

Esempio di installazione di un sistema completo  
Example of a complete ventilation system

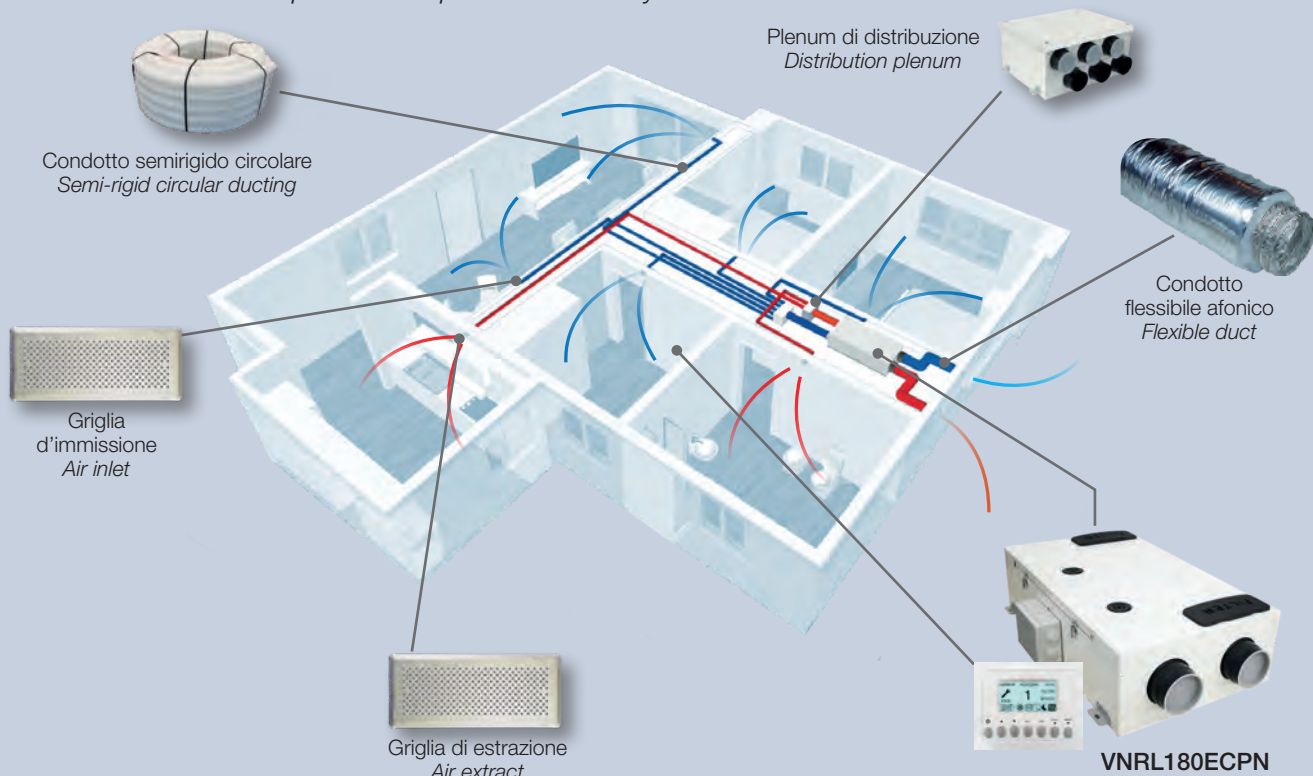

Codice Code	Modello Model	Portata Air flow m <sup>3</sup> /h max	Alimentazione Power supply V~	Consumo Power W max	Pressione sonora Sound Pressure dB(A) @3m	Temp.ambiente Ambient temp. °C max
VNRL180ECPN	LINEA	209	220/240 - 50/60Hz	105	21	40

**Note/Notes:** ✓ prestazioni aerauliche misurate secondo ISO 5801 a 230V 50Hz, densità dell'aria 1,2 Kg/m<sup>3</sup> - air performance measured according to ISO 5801 at 230V 50Hz, air density 1,2 Kg/m<sup>3</sup>  
 ✓ dati misurati in laboratorio accreditato TÜV Rheinland - data measured in TÜV Rheinland accredited laboratory

## Comandi e sensori ambiente Controls and ambient sensors



Igrostato  
Hygrostat

441079 (Domus) 445079 (Tekla)  
 442079 (Life) 449079 (Class)  
 443079 (Allumia)



Rilevatore PIR  
PIR sensor

441068RL (Domus) 445068RL (Tekla)  
 442068RL (Life) 446068RL (Whitek)  
 443068RL (Allumia) 449068RL (Class)



Per la disponibilità contattare la rete commerciale  
 For availability please contact sales dept.



Disponibilità fino ad esaurimento scorte  
 Available until stock out

**VMC centralizzata con recupero di calore "LINEA" e "VERTICAL"**  
**Centralised CMV heat recovery "LINEA" and "VERTICAL"**

	Descrizione <i>Description</i>	Info € □ □	677
 <p><b>VNRL180ECPN</b></p>  	<p><b>VNRL180ECPN</b>            Unità ventilante centralizzata a doppio flusso con recupero di calore per installazione in linea (soffitto o contro-soffitto) - fino a 82% di efficienza termica - compatta: solo 269 mm di altezza - motori EC brushless ad alto rendimento - portata massima 209 m<sup>3</sup>/h - attivazione automatica del bypass fisico integrato - pannello di comando esterno multi-funzione con display LCD fornito in dotazione - per ambienti con superficie sino a 130 m<sup>2</sup> - versione Plus - LINEA  <i>Whole house ventilation unit with heat recovery for in-line duct installation - up to 82% thermal efficiency - compact size: only 269mm high - EC brushless energy saving motors - maximum rate 209 m<sup>3</sup>/h - automatic activation by integrated physical bypass - remote multi-function control panel with LCD display supplied - for areas up to 130 m<sup>2</sup> - Plus version - LINEA</i></p>	<p>3918,17 1 1</p>	
 <p><b>VNRV280ECPN</b></p>  	<p><b>VNRV280ECPN</b>            Unità ventilante centralizzata a doppio flusso con recupero di calore per installazione a parete in posizione verticale - fino a 83% di efficienza termica - motori EC brushless ad alto rendimento - portata massima 281 m<sup>3</sup>/h - attivazione automatica del bypass fisico integrato - pannello di comando esterno multi-funzione con display LCD fornito in dotazione - per ambienti con superficie fino a 190 m<sup>2</sup>  <i>Centralised double flow ventilation unit with heat recovery for vertical installation - up to 83% thermal efficiency - EC brushless energy saving motors - maximum rate 281 m<sup>3</sup>/h - automatic activation by integrated physical bypass - remote multi-function control panel with LCD display supplied - for areas up to 190 m<sup>2</sup></i></p>	<p>3996,21 1 1</p>	
 <p><b>VNRV400ECPN</b></p>  	<p><b>VNRV400ECPN</b>            Unità ventilante centralizzata a doppio flusso con recupero di calore per installazione a parete in posizione verticale - fino a 86% di efficienza termica - motori EC brushless ad alto rendimento - portata massima 403 m<sup>3</sup>/h - attivazione automatica del bypass fisico integrato - pannello di comando esterno multi-funzione con display LCD fornito in dotazione - per ambienti con superficie sino a 270 m<sup>2</sup> - versione Plus - VERTICAL  <i>Centralised double flow ventilation unit with heat recovery for vertical installation - up to 86% thermal efficiency - EC brushless energy saving motors - maximum rate 403 m<sup>3</sup>/h - automatic activation by integrated physical bypass - remote multi-function control panel with LCD display supplied - for areas up to 270 m<sup>2</sup> - Plus version - VERTICAL</i></p>	<p>4197,18 1 1</p>	
 <p><b>VNRV550ECPN</b></p>  	<p><b>VNRV550ECPN</b>            Unità ventilante centralizzata a doppio flusso con recupero di calore per installazione a parete in posizione verticale - fino a 82% di efficienza termica - motori EC brushless ad alto rendimento - portata massima 550 m<sup>3</sup>/h - attivazione automatica del bypass fisico integrato - pannello di comando esterno multi-funzione con display LCD fornito in dotazione - per ambienti con superficie sino a 385 m<sup>2</sup> - versione Plus - VERTICAL  <i>Centralised double flow ventilation unit with heat recovery for vertical installation - up to 82% thermal efficiency - EC brushless energy saving motors - maximum rate 550 m<sup>3</sup>/h - automatic activation by integrated physical bypass - remote multi-function control panel with LCD display supplied - for areas up to 385 m<sup>2</sup> - Plus version - VERTICAL</i></p>	<p>4726,13 1 1</p>	

VENTILAZIONE  
VENTILATION

Le dimensioni, salvo diversamente specificato, sono in mm  
 Dimensions, except where otherwise specified, are in mm

Imballo Minimo pcs  
 Min. Packaging pcs

Imballo Standard pcs  
 Std. Packaging pcs

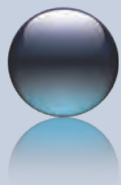

# DomusAir - Ventilazione residenziale

DomusAir - Residential ventilation

VMC decentralizzata

Decentralised CMV

678

Dimensioni (mm) Dimensions (mm)

Caratteristiche Tecniche Technical Features

## VNRD100EC - VNRD150EC

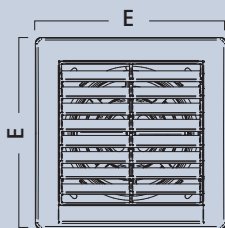
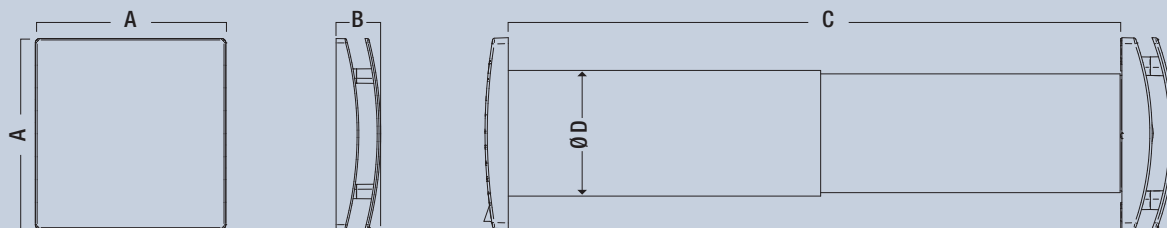

Modello Code	VNRD100EC	VNRD150EC
Peso Kg Weight Kg	2,3	3,9
A	164	218
B	46	51
C	300÷570	300÷570
ØD	108	158
E	164	218

## VNRD150ECP

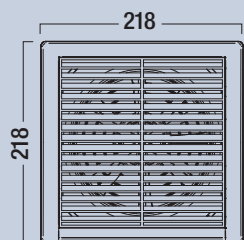
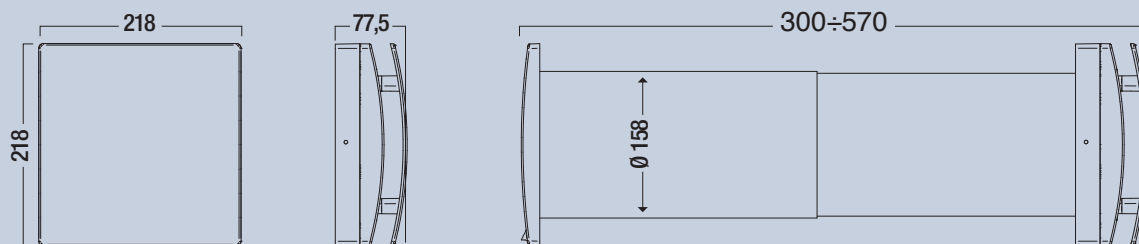

Modello Code	VNRD150ECP
Peso Kg Weight Kg	4,4

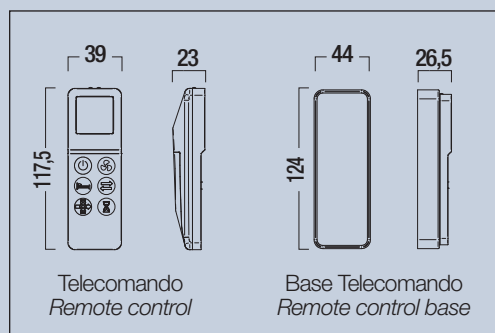

Per la disponibilità contattare la rete commerciale  
For availability please contact sales dept.



Disponibilità fino ad esaurimento scorte  
Available until stock out

**VMC decentralizzata**  
*Decentralised CMV*

Dimensioni (mm) *Dimensions (mm)*

VNDPS100

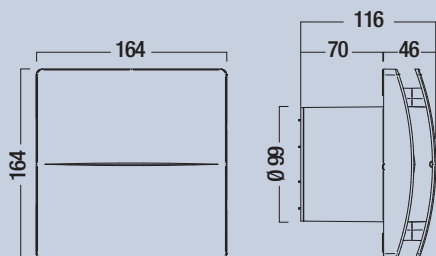

<b>Modello Code</b>	VNDPS100
<b>Peso Kg Weight Kg</b>	0,6

VNRP100EC

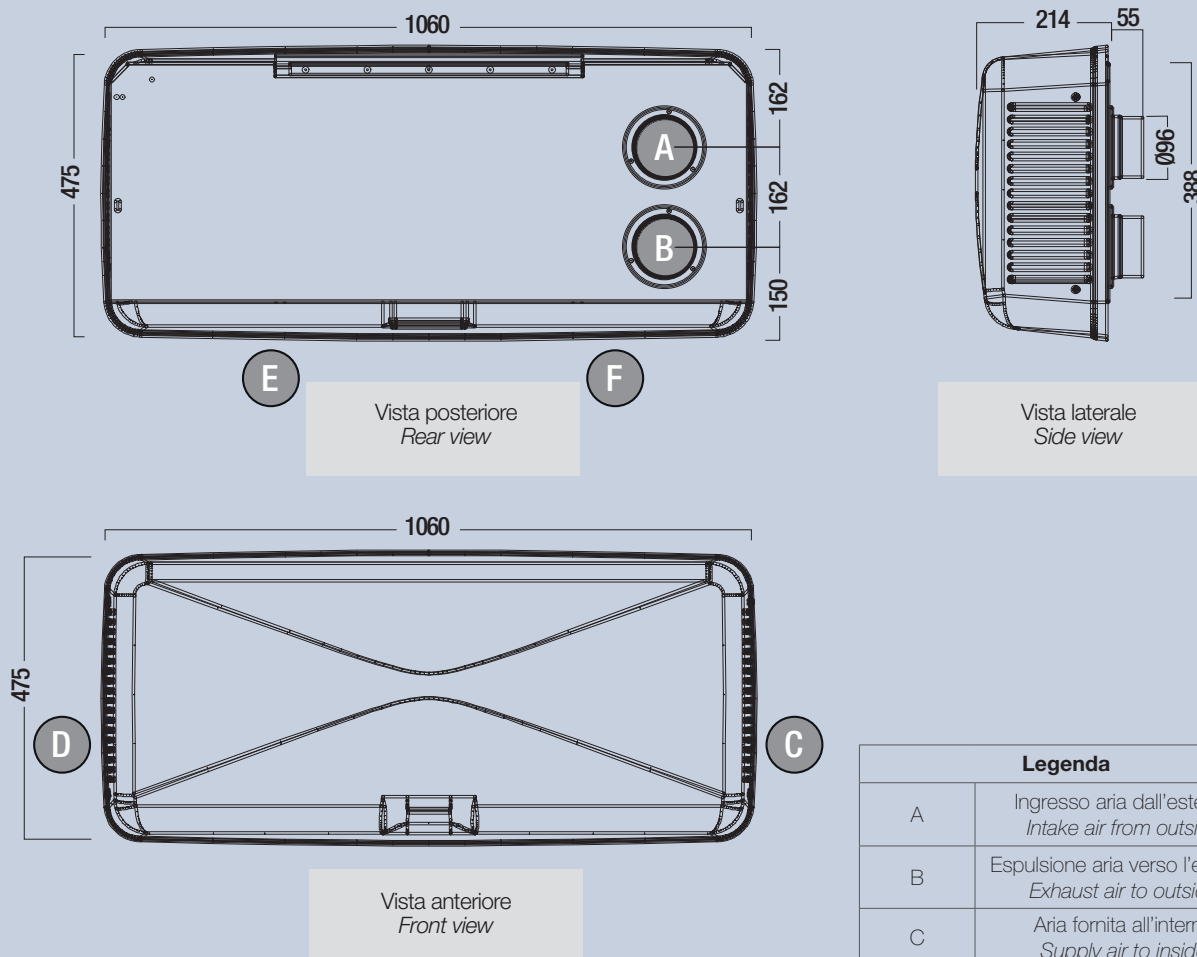

Vista posteriore  
*Rear view*

Vista laterale  
*Side view*

Vista anteriore  
*Front view*

Legenda	
A	Ingresso aria dall'esterno <i>Intake air from outside</i>
B	Espulsione aria verso l'esterno <i>Exhaust air to outside</i>
C	Aria fornita all'interno <i>Supply air to inside</i>
D	Aria estratta dall'interno <i>Extract air from inside</i>
E	Scarico condensa invernale <i>Winter condensation drain</i>
F	Scarico condensa estivo <i>Summer condensation drain</i>

<b>Modello Code</b>	VNRP100EC
<b>Peso Kg Weight Kg</b>	12,5

VENTILAZIONE  
VENTILATION

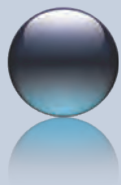

# DomusAir - Ventilazione residenziale

DomusAir - Residential ventilation

VMC centralizzata

Centralised CMV

680

Dimensioni (mm) Dimensions (mm)

VNRL180ECPN

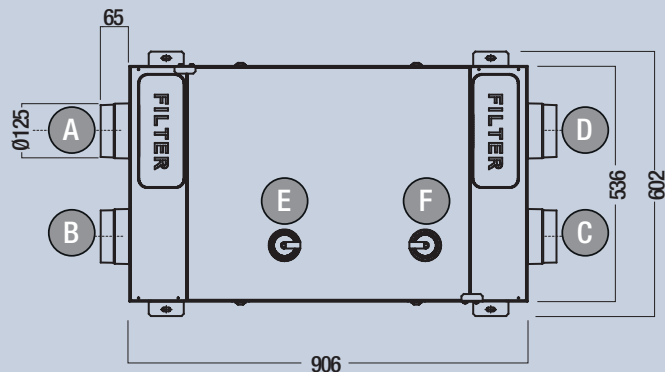

Vista dall'alto  
View from above



Vista laterale  
Side view

Modello Code	VNRL180ECPN
Peso Kg Weight Kg	20

Legenda	
A	Ingresso aria dall'esterno Intake air from outside
B	Espulsione aria verso l'esterno Exhaust air to outside
C	Aria fornita all'interno Supply air to inside
D	Aria estratta dall'interno Extract air from inside
E	Scarico condensa invernale Winter condensation drain
F	Scarico condensa estivo Summer condensation drain

VNRV280ECPN

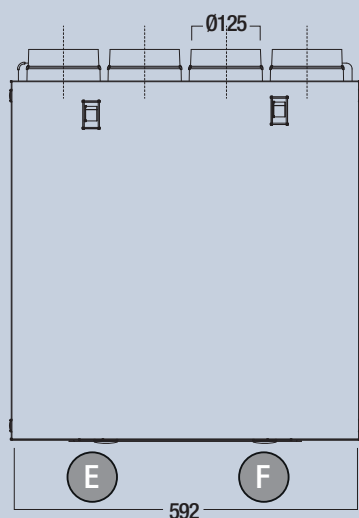

Vista frontale  
Front view

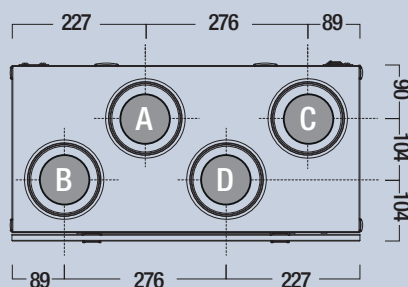

Vista dall'alto  
View from above

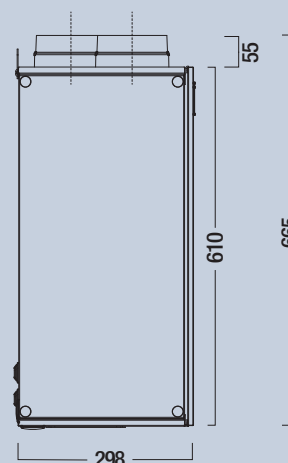

Vista laterale  
Side view

Modello Code	VNRV280ECPN
Peso Kg Weight Kg	23

Orientamento flussi SX  
SX flow orientation

Caratteristiche Tecniche Technical Features



Per la disponibilità contattare la rete commerciale  
For availability please contact sales dept.



Disponibilità fino ad esaurimento scorte  
Available until stock out



**VMC centralizzata**  
*Centralised CMV*

**Dimensioni (mm) Dimensions (mm)**

VNRV400ECPN

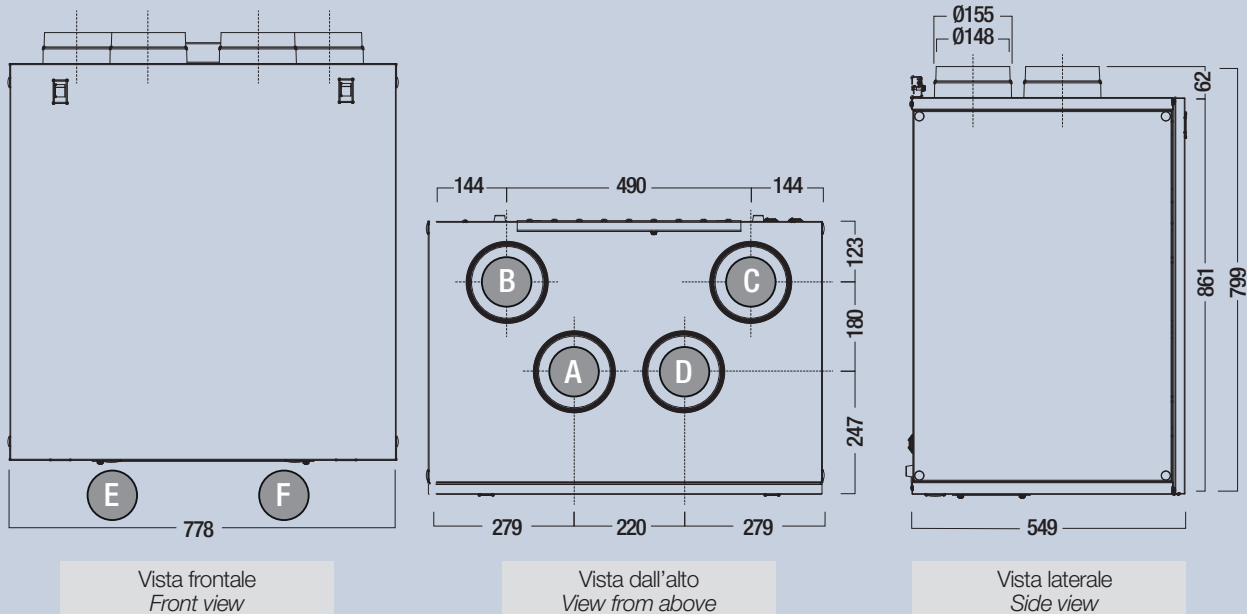

Vista frontale  
*Front view*

Vista dall'alto  
*View from above*

Vista laterale  
*Side view*

<b>Modello Code</b>	VNRV400ECPN
<b>Peso Kg Weight Kg</b>	34,5

Legenda	
A	Ingresso aria dall'esterno / Intake air from outside
B	Espulsione aria verso l'esterno / Exhaust air to outside
C	Aria fornita all'interno / Supply air to inside
D	Aria estratta dall'interno / Extract air from inside
E	Scarico condensa invernale / Winter condensation drain
F	Scarico condensa estivo / Summer condensation drain

VNRV550ECPN

Orientamento flussi SX  
*SX flow orientation*

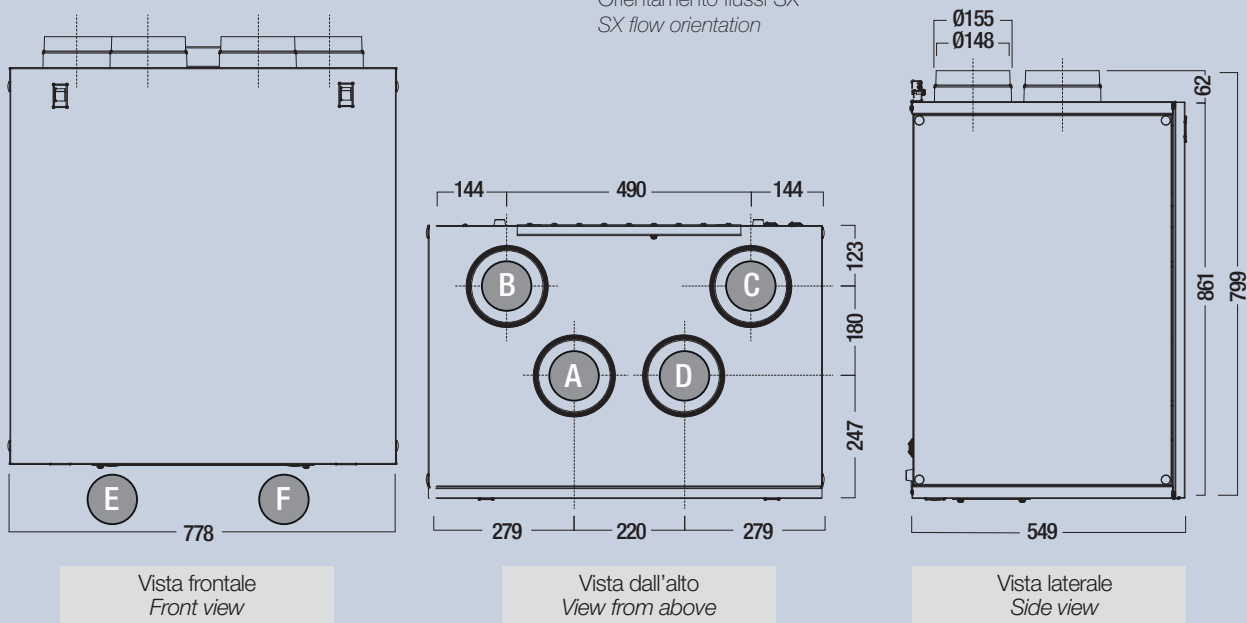

Vista frontale  
*Front view*

Vista dall'alto  
*View from above*

Vista laterale  
*Side view*

<b>Modello Code</b>	VNRV550ECPN
<b>Peso Kg Weight Kg</b>	44

VENTILAZIONE  
VENTILATION

Le dimensioni, salvo diversamente specificato, sono in mm  
Dimensions, except where otherwise specified, are in mm

Imballo Minimo pcs  
Min. Packaging pcs

Imballo Standard pcs  
Std. Packaging pcs

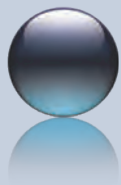

# DomusAir - Ventilazione residenziale





DomusAir - Residential ventilation

Abbinamento prodotti - componenti sistema di distribuzione

Matching products - distribution system components

682

## Caratteristiche Tecniche Technical Features

Codice Code	 VNRP100EC	 VNRL180ECPN	 VNRV280ECPN	 VNRV400ECPN	 VNRV550ECPN
VNXE125CNDP		✓	✓		
VNXE160CNDP				✓	✓
VNXE125KTM		✓	✓		
VNXE150KTM				✓	✓
VNXE100TIE	✓				
VNXE125TIE		✓	✓		
VNXE150TIE				✓	✓





Per la disponibilità contattare la rete commerciale  
For availability please contact sales dept.



Disponibilità fino ad esaurimento scorte  
Available until stock out

Sistema di distribuzione aria per VMC canalizzata  
Air distribution system for centralised CMV

		Descrizione <i>Description</i>	Info	€	<input type="checkbox"/>	<input type="checkbox"/>	683
 VNXE125CNDF VNXE160CNDF	VNXE125CNDF	Condotto flessibile afonico realizzato con parete di alluminio/poliestere/alluminio microforato e spirale elicoidale in filo acciaio armonico Ø125mm - rivestimento termoisolante e protezione esterna in film alluminato - lunghezza 10m <i>Flexible duct made with aluminium/polyester/micro-perforated aluminium walls to reduce air-flow noise and steel wire helix. - Ø125mm - Thermo-insulating covering and outer aluminized polyolefin film protection - lenght 10m</i>		205,83	1	1	
	VNXE160CNDF	Condotto flessibile afonico realizzato con parete di alluminio/poliestere/alluminio microforato e spirale elicoidale in filo acciaio armonico Ø160mm - rivestimento termoisolante e protezione esterna in film alluminato - lunghezza 10m <i>Flexible duct made with aluminium/polyester/micro-perforated aluminium walls to reduce air-flow noise and steel wire helix. - Ø160mm - Thermo-insulating covering and outer aluminized polyolefin film protection-lenght 10m</i>		251,56	1	1	
 VNXE125KTM	VNXE125KTM	Kit attraversamento muro con terminale esterno e materassino fonoassorbente Ø125mm <i>Through-wall kit with external hood and internal acoustic lining Ø125mm</i>		100,94	1	1	
	VNXE150KTM	Kit attraversamento muro con terminale esterno e materassino fonoassorbente Ø150mm <i>Through-wall kit with external hood and internal acoustic lining Ø150mm</i>		122,35	1	1	
 VNXE100TIE VNXE125TIE VNXE150TIE	VNXE100TIE	Terminale esterno in INOX Ø100mm <i>External outlet in stainless steel Ø100mm</i>		64,38	1	1	
	VNXE125TIE	Terminale esterno in INOX Ø125mm <i>External outlet in stainless steel Ø125mm</i>		84,02	1	1	
	VNXE150TIE	Terminale esterno in INOX Ø150mm <i>External outlet in stainless steel Ø150mm</i>		98,47	1	1	

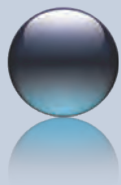

# DomusAir - Ventilazione residenziale

## DomusAir - Residential ventilation

Abbinamento prodotti - componenti sistema di distribuzione

Matching products - distribution system components

684

### Caratteristiche Tecniche Technical Features

Codice Code	 VNRL180ECPN	 VNRV280ECPN	 VNRV400ECPN	 VNRV550ECPN
VNXI63CNDF	✓	✓	✓	✓
VNXI63GNT	✓	✓	✓	✓
VNXI63CRV	✓	✓	✓	✓
VNXI125PM			✓	✓
VNXI125PML			✓	✓
VNXI63PM/6B	✓	✓		
VNXI63PM/10B			✓	✓
VNXI63PM/15B			✓	✓
VNXI63ORI	✓	✓	✓	✓
VNXI63TAP	✓	✓	✓	✓



Per la disponibilità contattare la rete commerciale  
For availability please contact sales dept.



Disponibilità fino ad esaurimento scorte  
Available until stock out

**Sistema di distribuzione aria per VMC canalizzata**  
*Air distribution system for centralised CMV*

		Descrizione <i>Description</i>	Info	€	<input type="checkbox"/>	<input type="checkbox"/>	685
	<b>VN XI 63 C NDF</b>	<b>VN XI 63 C NDF</b> Condotto semirigido circolare per installazione sotto pavimento, nei controsoffitti o nelle pareti Ø75/63mm - esterno corrugato, interno liscio, realizzato in polietilene - lunghezza rotolo 50m <i>Semi-rigid circular ducting for under floor, suspended ceiling and walls installation Ø75/63mm - corrugated external side, smooth internal side, made in polyethylene - 50m length.</i>		<b>293,88</b>	1	1	
	<b>VN XI 63 G NT</b>	<b>VN XI 63 G NT</b> Giunto di collegamento in polipropilene Ø75/63mm (incluso o-ring di tenuta) <i>Connection element in polypropylene Ø75/63mm (sealing rings included).</i>		<b>26,53</b>	1	1	
	<b>VN XI 63 C RV</b>	<b>VN XI 63 C RV</b> Curva 90° realizzata in polietilene per innesto diretto su condotto semirigido circolare Ø75/63mm (incluso o-ring di tenuta) <i>90° vertical bend in polyethylene for quick connection to the semi-rigid circular ducting Ø75/63mm (sealing rings included)</i>		<b>58,33</b>	1	1	
	<b>VN XI 125 P M</b>	<b>VN XI 125 P M</b> Plenum di distribuzione in lamiera zincata con materassino fonoassorbente, ispezionabile - 1 ingresso Ø150mm - 2 uscite posteriori Ø125mm - 3 tappi <i>Distribution plenum in galvanised steel with acoustic lining, easy to maintain 1 inlet Ø150mm - 2 rear or side outlets Ø125mm - 3 caps</i>		<b>112,31</b>	1	1	
	<b>VN XI 125 P ML</b>	<b>VN XI 125 P ML</b> Plenum di distribuzione in lamiera zincata con materassino fonoassorbente, ispezionabile - 1 ingresso Ø150mm - 2 uscite laterali Ø125mm - 3 tappi <i>Distribution plenum in galvanised steel with acoustic lining, easy to maintain 1 inlet Ø150mm - 2 rear or side outlets Ø125mm - 3 caps</i>		<b>112,31</b>	1	1	
	<b>VN XI 125 P ML</b>	<b>VN XI 125 P ML</b> Plenum di distribuzione in lamiera zincata con materassino fonoassorbente, ispezionabile - 1 ingresso Ø150mm - 6 uscite posteriori Ø80mm - 7 tappi <i>Distribution plenum in galvanised steel with acoustic lining, easy to maintain - 1 inlet Ø150mm - 6 rear outlets Ø80mm - 7 caps</i>		<b>262,91</b>	1	1	
	<b>VN XI 125 P ML</b>	<b>VN XI 125 P ML</b> Plenum di distribuzione in lamiera zincata con materassino fonoassorbente, ispezionabile - 1 ingresso Ø150mm - 10 uscite posteriori Ø80mm - 11 tappi <i>Distribution plenum in galvanised steel with acoustic lining, easy to maintain - 1 inlet Ø150mm - 10 rear outlets Ø80mm - 11 caps</i>		<b>259,89</b>	1	1	
	<b>VN XI 63 P M / 6 B</b>	<b>VN XI 63 P M / 6 B</b> Plenum di distribuzione in lamiera zincata con materassino fonoassorbente, ispezionabile - 1 ingresso Ø150mm - 15 uscite posteriori Ø80mm - 16 tappi <i>Distribution plenum in galvanised steel with acoustic lining, easy to maintain - 1 inlet Ø150mm - 15 rear outlets Ø80mm - 16 caps</i>		<b>314,46</b>	1	1	
	<b>VN XI 63 O RI</b>	<b>VN XI 63 O RI</b> Anello o-ring di tenuta per attacchi Plenum Ø80mm - 10 pezzi <i>Sealing ring for outlet Plenum Ø80mm - 10 pcs</i>		<b>35,03</b>	1	1	
	<b>VN XI 63 T AP</b>	<b>VN XI 63 T AP</b> Tappo in polietilene Ø80mm <i>Protective cap in polyethylene Ø80mm</i>		<b>2,34</b>	3	3	





# DomusAir - Ventilazione residenziale

## DomusAir - Residential ventilation

Sistema di distribuzione aria per VMC canalizzata  
Air distribution system for centralised CMV

686

Descrizione Description

Info

€

□

□



VNXI80BRD VNXI125BRD  
VNXI100BRD VNXI150BRD

**VNXI80BRD**  
Bocchetta Design di estrazione/immissione regolabile Ø80mm, per attacco a condotto cod. VNXI63CNDF  
*Design adjustable grille, for extract and intake Ø80mm, for duct code VNXI63CNDF.*

30,57 1 1

**VNXI100BRD**  
Bocchetta Design di estrazione/immissione regolabile Ø100mm, per Plenum codd. VNXI63PML/140L-VNXI63PM/140L  
*Design adjustable grille, for extract and intake Ø100mm, for plenum codd. VNXI63PML/140L-VNXI63PM/140L.*

30,57 1 1

**VNXI125BRD**  
Bocchetta Design di estrazione/immissione regolabile Ø125mm, per attacco a condotto cod. VNXE125CNDF  
*Design adjustable grille, for extract and intake Ø125mm, for duct code VNXE125CNDF.*

38,17 1 1



VNXI63PML/140L

**VNXI150BRD**  
Bocchetta Design di estrazione/immissione regolabile Ø150mm, per plenum codd. VNXI63PML/200L-VNXI63PM/200L  
*Design adjustable grille, for extract and intake Ø150mm, for plenum codd. VNXI63PML/200L-VNXI63PM/200L.*

38,55 1 1

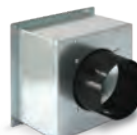

VNXI63PM/140L

**VNXI63PML/140L**  
Plenum in lamiera zincata per bocchetta codd. VNXI80BRD e VNXI100BRD - 1 attacco laterale Ø80mm - chiusura anti-malta - 1 tappo  
*Outer plenum in galvanised steel for design grilles codes VNXI80BRD and VNXI100BRD - 1 side outlet Ø80mm - anti-mortar closure - 1 cap*

63,12 1 1

**VNXI63PM/140L**  
Plenum in lamiera zincata per bocchetta codd. VNXI80BRD e VNXI100BRD - 1 attacco posteriore Ø80mm - chiusura anti-malta - 1 tappo  
*Outer plenum in galvanised steel for design grilles codes VNXI80BRD and VNXI100BRD - 1 rear outlet Ø80mm - anti-mortar closure - 1 cap*

58,06 1 1

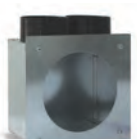

VNXI63PML/200L

**VNXI63PML/200L**  
Plenum in lamiera zincata per bocchetta codd. VNXI125BRD e VNXI150BRD - 2 attacchi laterali Ø80mm - chiusura anti-malta - 2 tappi  
*Outer plenum in galvanised steel for design grilles codes VNXI125BRD and VNXI150BRD - 2 side outlets Ø80mm - anti-mortar closure - 2 caps*

101,17 1 1

**VNXI63PM/200L**  
Plenum in lamiera zincata per bocchetta codd. VNXI125BRD e VNXI150BRD - 2 attacchi posteriori Ø80mm - chiusura anti-malta - 2 tappi  
*Outer plenum in galvanised steel for design grilles codes VNXI125BRD and VNXI150BRD - 2 rear outlets Ø80mm - anti-mortar closure - 2 caps*

94,08 1 1

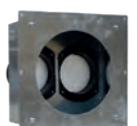

VNXI63PM/200L

**VNXI125PM/200L**  
Plenum in lamiera zincata per bocchetta codd. VNXI125BRD e VNXI150BRD - 1 attacco posteriore Ø125mm - chiusura anti-malta - 1 tappo  
*Outer plenum in galvanised steel for design grilles codes VNXI125BRD and VNXI150BRD - 1 rear outlet Ø125mm - anti-mortar closure - 1 cap*

96,91 1 1

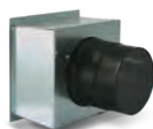

VNXI125PM/200L



Per la disponibilità contattare la rete commerciale  
For availability please contact sales dept.



Disponibilità fino ad esaurimento scorte  
Available until stock out

**Sistema di distribuzione aria per VMC canalizzata**  
*Air distribution system for centralised CMV*

	Descrizione <i>Description</i>	Info	€	<input type="checkbox"/>	<input type="checkbox"/>	687
	<b>VNXIGF/200L</b> Griglia rettangolare a schermo forellato, per parete, RAL9010 - 200x100mm <i>Architectural grille for wall mouting, white colour RAL9010 - 200x100mm</i>		57,28	1	1	
VNXIGF/200L VNXIGF/300L	<b>VNXIGF/300L</b> Griglia rettangolare a schermo forellato, per parete, RAL9010 - 300x100mm <i>Architectural grille for wall mouting, white colour RAL9010 - 300x100mm</i>		64,88	1	1	
	<b>VNXI63PMSL/200L</b> Plenum in lamiera zincata di immissione/estrazione, per griglie cod. VNXIGF/200L - 1 attacco laterale Ø80mm - 1 tappo <i>Outlet plenum in galvanised steel for grilles code VNXIGF/200L - 1 side outlet Ø80mm - 1 cap</i>		72,71	1	1	
VNXI63PMSL/200L	<b>VNXI63PMSL/300L</b> Plenum in lamiera zincata di immissione/estrazione, per griglie codd. VNXIGF/300L - 2 attacchi laterali Ø80mm - 2 tappi <i>Outlet plenum in galvanised steel for grilles code VNXIGF/300L. 2 side outlets Ø80mm - 2 caps</i>		81,82	1	1	
	<b>VNXI63PMS/200L</b> Plenum in lamiera zincata di immissione/estrazione, per griglie cod. VNXIGF/200L - 1 attacco posteriore Ø80mm - 1 tappo <i>Outlet plenum in galvanised steel for grilles code VNXIGF/200L - 1 rear outlet Ø80mm - 1 cap</i>		72,71	1	1	
VNXI63PMS/300L	<b>VNXI63PMS/300L</b> Plenum in lamiera zincata di immissione/estrazione, per griglie cod. VNXIGF/300L - 2 attacchi posteriori Ø80mm - 2 tappi <i>Outlet plenum in galvanised steel for grilles code VNXIGF/300L - 2 rear outlets Ø80mm - 2 caps</i>		81,82	1	1	
	<b>VNXI125VES/IM</b> Valvola di immissione/estrazione in plastica con anello di sicurezza Ø125mm, per adattatore cod. VNXI63ADT <i>Intake/extract valve in plastic with safety ring Ø125mm for adaptor code VNXI63ADT</i>		17,34	10	10	
VNXI63PMS/200L	<b>VNXI63ADT</b> Adattatore ad angolo 90° in lamiera zincata per valvola di immissione/estrazione cod. VNXI125VES/IM e bocchetta design VNXI125BRD - 2 ingressi Ø80mm - 1 uscita 125mm - 2 tappi <i>90 ° angled adapter in galvanized sheet for intake/extraction valve code VNXI125VES/IM and design nozzle VNXI125BRD - 2 inputs Ø80mm - 1 output 125mm - 2 caps</i>		73,21	1	1	
						
VNXI63PMS/300L						
	<b>VNXI125VES/IM</b>					
	<b>VNXI63ADT</b>					



## DomusAir - Ventilazione residenziale

DomusAir - Residential ventilation

Accessori e parti di ricambio per VMC

Accessories and spare parts for CMV

688

Descrizione Description

Info

€

□

□



VNGE100R  
VNGE150R

**VNGE100R**

Griglia fissa esterna Ø100mm con rete anti-insetto  
External fixed grille Ø100mm with anti-insect net

19,99

4 4

**VNGE150R**

Griglia fissa esterna Ø150mm con rete anti-insetto  
External fixed grille Ø150mm with anti-insect net

23,31

4 4



VNCNDT125

**VNCNDT100**

Condotto telescopico in ABS 100% riciclato - Ø100mm, L300-570mm  
Telescopic ducting in recycled ABS - Ø100mm, L300-570mm

13,78

1 1

**VNCNDT125**

Condotto telescopico in PVC - Ø125mm, L300-570mm  
Telescopic ducting in PVC - Ø125mm, L300-570mm

17,67

1 1

**VNCNDT150**

Condotto telescopico in ABS 100% riciclato - Ø150mm, L300-570mm  
Telescopic ducting in recycled ABS - Ø150mm, L300-570mm

20,23

1 1



VNCNDT100  
VNCNDT150

**VNWAUTO**

Ingresso aria autoregolabile per installazione zona finestra, 30m³/h  
Self-adjusting acoustic window inlet, 30m³/h

53,72

1 1

**VNwigro**

Ingresso aria igroregolabile per installazione zona finestra  
Humidity sensitive acoustic window inlet

130,95

1 1



VNWAUTO



VNwigro



Per la disponibilità contattare  
la rete commerciale  
For availability please contact  
sales dept.



Disponibilità fino ad  
esaurimento scorte  
Available until stock out

Accessori e parti di ricambio per VMC  
Accessories and spare parts for CMV

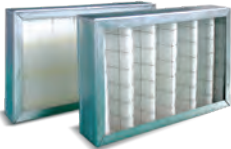
		Descrizione <i>Description</i>	Info	€	<input type="checkbox"/>	<input type="checkbox"/>	689
	VNKF100 VNKF150	<b>VNKF100</b> Kit 3 filtri anti-polvere per unità ventilante cod. VNRD100EC con cornice di supporto <i>Kit of 3 anti-dust filters for ventilation unit VNRD100EC with support frame.</i>		20,30	1	1	
		<b>VNKF150</b> Kit 3 filtri anti-polvere per unità ventilante cod. VNRD150EC e VNRD150ECP con cornice di supporto <i>Kit of 3 anti-dust filters for ventilation unit VNRD150EC and VNRD150ECP with support frame.</i>		27,25	1	1	
	VNCF200F7	<b>VNCF200F7</b> Cassetta filtro F7 Ø125mm per recuperatori di calore codd. VNRL180ECPN e VNRV280ECPN <i>External F7 filter cassette for codes VNRV180ECP and VNRV280ECPN</i>		158,96	1	1	
		<b>VNKF100G4</b> Filtri ricambio per recuperatore di calore cod. VNRP100EC - 2x filtro G4 <i>Filter replacement for code VNRP100EC - 2x filter G4</i>		50,98	1	1	
	VNKF100G4 VNF100F7 VNKF200G4	<b>VNF100F7</b> Filtri ricambio per recuperatore di calore cod. VNRP100EC - 1x filtro F7 <i>Filter replacement for code VNRP100EC - 1x filter F7</i>		79,22	1	1	
		<b>VNKF200G4</b> Filtri ricambio per recuperatori di calore cod. VNRL180ECPN - 2x filtro G4 <i>Filter replacement for codes VNRL180ECPN - 2x filter G4</i>		49,96	1	1	
		<b>VNKF400G4</b> Filtri ricambio per recuperatori di calore codd. VNRV400ECPN e VNRV550ECPN - 2x filtro G4 <i>Filter replacement for codes VNRV400ECPN and VNRV550ECPN - 2x filter G4</i>		45,41	1	1	
	VNKF400G4 VNF400F7	<b>VNF400F7</b> Filtri ricambio per recuperatori di calore codd. VNRV400ECPN e VNRV550ECPN e cassetta filtro cod. VNCF200F7 - 1x filtro F7 <i>Filter replacement for codes VNRV400ECPN and VNRV550ECPN and filter cassette code VNCF200F7 range - 1x filter F7</i>		92,71	1	1	