

# Placche delle Serie Civili

## Sistema 44

### System 44

Wiring Accessories front plates



**Design:**

B. Dall'Eco  
L. Merletti  
S. Micheli

# Indice

## Index

<p>Placche CORIAN® CORIAN® front plates</p>	<p><b>162</b></p>	
<p>Placche METALLO METAL front plates</p>	<p><b>172</b></p>	
<p>Placche ALLUMINIO ALUMINIUM front plates</p>	<p><b>180</b></p>	
<p>Placche VETRO Vera 44 GLASS front plates</p>	<p><b>200</b></p>	
<p>Placche LEGNO WOOD front plates</p>	<p><b>220</b></p>	
<p>Placche ZAMA ZAMA front plates</p>	<p><b>228</b></p>	
<p>Placche TECNOPOLIMERO MOULDED front plates</p>	<p><b>238</b></p>	
<p>CONFIGURATORE e Placche personalizzabili CUSTOMIZABLE plates configurator</p>	<p><b>270</b></p>	

# Placche

## Front Plates



Design:  
L. Merletti

162

I colori delle placche "PILLS Corian® "per scatola rettangolare  
"PILLS Corian® front plates colours for rectangular box



**44PSMCTC01B**  
Corian® touch bianco  
White touch Corian®



**44PSMCTC02B**  
Corian® touch bianco  
White touch Corian®



**44PSMCTC3B**  
Corian® touch bianco  
White touch Corian®



**44PSMCTC16B**  
Corian® touch bianco  
White touch Corian®



**44PSMCTC4B**  
Corian® touch bianco  
White touch Corian®



**44PSMC3B**  
Corian® bianco  
White Corian®



**44PSMC4B**  
Corian® bianco  
White Corian®

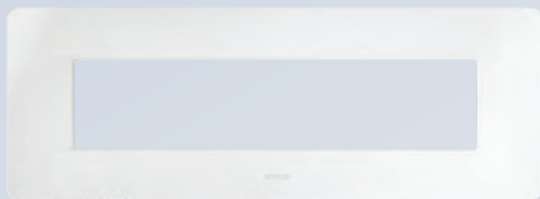

**44PSMC7B**  
Corian® bianco  
White Corian®

**I colori delle placche "New Style 44 Corian®"**  
**"New Style 44 Corian®" front plates colours**



**44PCNT21B**  
Corian® comando  
a levetta  
*Toggle control Corian®*



**44PCNT22B**  
Corian® comando  
a levetta  
*Toggle control Corian®*



**44PCN01B**  
Corian® comando  
a levetta  
*Toggle control Corian®*



**44PCN02B**  
Corian® comando  
a levetta  
*Toggle control Corian®*



**44PCN03B**  
Corian® comando  
a levetta  
*Toggle control Corian®*



**44PCN04B**  
Corian® comando  
a levetta  
*Toggle control Corian®*



**44PCT22B**  
Corian® comando  
standard  
*Control Corian®*



**44PC22B**  
Corian® comando  
standard  
*Control Corian®*



**44PC24B**  
Corian® comando  
standard  
*Control Corian®*



**44PC26B**  
Corian® comando  
standard  
*Control Corian®*



**44PC28B**  
Corian® comando  
standard  
*Control Corian®*



**44PCN3B**  
Corian® standard  
*Standard Corian®*



**44PCN4B**  
Corian® standard  
*Standard Corian®*

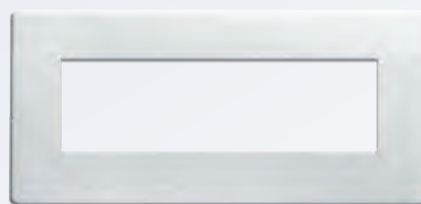

**44PCN7B**  
Corian® standard  
*Standard Corian®*



# Placche Corian®

## Corian® front plates

NEW WIRING ACCESSORIES

Placche "Pills Smart Touch 44" in Corian® per scatola 3 moduli (interasse 83,5 mm)  
 "Pills Smart Touch 44" Corian® front plates for rectangular 3 modules box (fixing centres 83,5 mm)

164



Descrizione Description

Info

€

□

□

Per 1 comando "a scomparsa"  
 For 1 "hidden" control

□ 44PSMCTC01B

Bianco  
 White



1 1

**Nota:** assicurarsi che la placca sia perfettamente aderente agli apparecchi di comando "a scomparsa"

**Note:** make sure that the front plate sticks perfectly to the "hidden" control devices



Descrizione Description

Info

€

□

□

Per 2 comandi "a scomparsa"  
 For 2 "hidden" controls

□ 44PSMCTC02B

Bianco  
 White



1 1

**Nota:** assicurarsi che la placca sia perfettamente aderente agli apparecchi di comando "a scomparsa"

**Note:** make sure that the front plate sticks perfectly to the "hidden" control devices



Descrizione Description

Info

€

□

□

Per 3 comandi "a scomparsa"  
 For 3 "hidden" controls

□ 44PSMCTC3B

Bianco  
 White



1 1

**Nota:** assicurarsi che la placca sia perfettamente aderente agli apparecchi di comando "a scomparsa"

**Note:** make sure that the front plate sticks perfectly to the "hidden" control devices

Supporto da utilizzare  
 To be used with



44A03SM

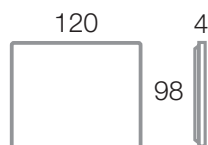

Scatole utilizzabili  
 Available boxes



2503MG

253X4

Pareti in muratura  
 Brickwork walls



253CGPR

253CG

253X4CG

Pareti in cartongesso  
 Hollow walls



Per la disponibilità contattare  
 la rete commerciale  
 For availability please contact  
 sales dept.



Disponibilità fino ad  
 esaurimento scorte  
 Available until stock out



Prodotto per scatola  
 rettangolare inglese  
 Product for British standard  
 rectangular box



Prodotto  
 per Export  
 For Export  
 only

**Placche "Pills Smart Touch 44" in Corian® per scatola 3 moduli (interasse 83,5 mm)**  
**"Pills Smart Touch 44" Corian® front plates for rectangular 3 modules box (fixing centres 83,5 mm)**

Descrizione Description	Info	€	□	□	165
<p>Fino a 6 (3+3) comandi "a scomparsa" Up to 6 (3+3) "hidden" controls</p> <p>□ <b>44PSMCTC16B</b> Bianco White</p> <p><b>Nota:</b> Assicurarsi che la placca sia perfettamente aderente agli apparecchi di comando "a scomparsa". Completare con tappo copriforo 442TC13R i moduli non utilizzati. <b>Note:</b> Make sure that the front plate sticks perfectly to the "hidden" control devices. Use the 442TC13R blank insert for empty modules</p>	NEW		1	1	



Supporto da utilizzare  
To be used with



44A03SM

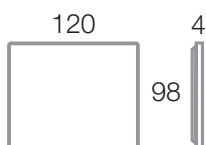

Scatole utilizzabili  
Available boxes



Pareti in muratura  
Brickwork walls



Pareti in cartongesso  
Hollow walls

**Placche "Pills Smart Touch 44" in Corian® per scatola 4 moduli (interasse 108,5 mm)**  
**"Pills Smart Touch 44" Corian® front plates for rectangular 4 modules box (fixing centres 108,5 mm)**

Descrizione Description	Info	€	□	□	
<p>Per 4 comandi "a scomparsa" For 4 "hidden" controls</p> <p>□ <b>44PSMCTC4B</b> Bianco White</p> <p><b>Nota:</b> assicurarsi che la placca sia perfettamente aderente agli apparecchi di comando "a scomparsa" <b>Note:</b> make sure that the front plate sticks perfectly to the "hidden" control devices</p>	NEW		1	1	



Supporto da utilizzare  
To be used with



44A04SM



Scatole utilizzabili  
Available boxes



Pareti in muratura  
Brickwork walls



Pareti in cartongesso  
Hollow walls



# Placche Corian®

## Corian® front plates



Placche "Pills Smart 44" in Corian® per scatola 3 moduli (interasse 83,5 mm)  
 "Pills Smart 44" Corian® front plates for rectangular 3 modules box (fixing centres 83,5 mm)

166

Descrizione Description	Info	€	□	□
-------------------------	------	---	---	---



Per 3 comandi standard 44  
 For 3 S44 standard controls

□ 44PSMC3B  
 Bianco  
 White



1 1

Supporto da utilizzare  
 To be used with



44A03SM

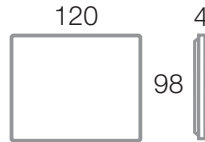

Scatole utilizzabili  
 Available boxes



2503MG

253X4

Pareti in muratura  
 Brickwork walls



253CGPR

253CG

253X4CG

Pareti in cartongesso  
 Hollow walls

Placche "Pills Smart 44" in Corian® per scatola 4 moduli (interasse 108,5 mm)  
 "Pills Smart 44" Corian® front plates for rectangular 4 modules box (fixing centres 108,5 mm)

Descrizione Description	Info	€	□	□
-------------------------	------	---	---	---



Per 4 comandi standard 44  
 For 4 S44 standard controls

□ 44PSMC4B  
 Bianco  
 White



1 1

Supporto da utilizzare  
 To be used with



44A04SM

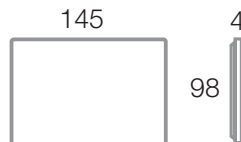

Scatole utilizzabili  
 Available boxes



2504

253X4

Pareti in muratura  
 Brickwork walls



254CGPR

254CG

253X4CG

Pareti in cartongesso  
 Hollow walls

Placche "Pills Smart 44" in Corian® per scatola 7 moduli (interasse 158,5 mm)  
 "Pills Smart 44" Corian® front plates for rectangular 7 modules box (fixing centres 158,5 mm)

Descrizione Description	Info	€	□	□
-------------------------	------	---	---	---



Per 7 comandi standard 44  
 For 7 S44 standard controls

□ 44PSMC7B  
 Bianco  
 White



1 1

Supporto da utilizzare  
 To be used with



44A07SM

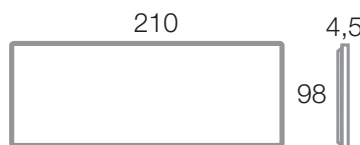

Scatole utilizzabili  
 Available boxes



2506

Pareti in muratura  
 Brickwork walls



256CG

Pareti in cartongesso  
 Hollow walls



Per la disponibilità contattare  
 la rete commerciale  
 For availability please contact  
 sales dept.



Disponibilità fino ad  
 esaurimento scorte  
 Available until stock out



Prodotto per scatola  
 rettangolare inglese  
 Product for British standard  
 rectangular box



Prodotto  
 per Export  
 For Export  
 only

Placche "Pills 44" in Corian® per scatola tonda e quadrata  
 "Pills 44" Corian® front plates for round and square box

Descrizione Description	Info	€	□	□	167
 <p>Per 2 comandi standard 44            For 2 S44 standard controls</p>	<input type="checkbox"/> 44PC22B Bianco White				1 1

Supporto da utilizzare  
 To be used with



44A02  
 44A02SG  
 44A02VT

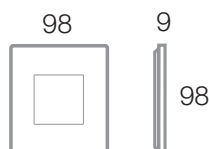

Scatole utilizzabili  
 Available boxes



Pareti in muratura  
 Brickwork walls

Pareti in cartongesso  
 Hollow walls



## NEW STYLE 44

Placche "New Style 44" in Corian® per scatola tonda e quadrata  
 "New Style 44" Corian® front plates for round and square box

Descrizione Description	Info	€	□	□	
 <p>Per 1 comando a levetta            For 1 toggle control</p>	<input type="checkbox"/> 44PCNT21B Bianco White				1 1



Descrizione Description	Info	€	□	□	
 <p>Per 2 comandi a levetta            For 2 toggle controls</p>	<input type="checkbox"/> 44PCNT22B Bianco White				1 1

Supporto da utilizzare  
 To be used with



44A02  
 44A02SG  
 44A02VT

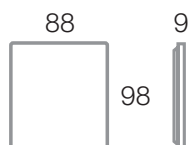

Scatole utilizzabili  
 Available boxes



Pareti in muratura  
 Brickwork walls

Pareti in cartongesso  
 Hollow walls

Le dimensioni, salvo diversamente specificato, sono in mm  
 Dimensions, except where otherwise specified, are in mm

Imballo Minimo pcs  
 Min. Packaging pcs

Imballo Standard pcs  
 Std. Packaging pcs





# Placche Corian®

## Corian® front plates



Placche "New Style 44" in Corian® per scatola 3 moduli (interasse 83,5 mm)  
 "New Style 44" front plates for rectangular 3 modules box (fixing centres 83,5 mm)

168



Descrizione Description

Info

€

□

□

Per 1 comando a levetta  
 For 1 toggle control

□ 44PCN01B  
 Bianco  
 White

1 1



Descrizione Description

Info

€

□

□

Per 2 comandi a levetta  
 For 2 toggle controls

□ 44PCN02B  
 Bianco  
 White

1 1



Descrizione Description

Info

€

□

□

Per 3 comandi a levetta  
 For 3 toggle controls

□ 44PCN03B  
 Bianco  
 White

1 1

Supporto da utilizzare  
 To be used with



44A03

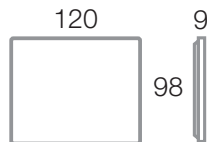

Scatole utilizzabili  
 Available boxes



2503MG

253X4

Pareti in muratura  
 Brickwork walls



253CGPR

253CG

253X4CG

Pareti in cartongesso  
 Hollow walls

Placche "New Style 44" in Corian® per scatola 4 moduli (interasse 108,5 mm)  
 "New Style 44" front plates for rectangular 4 modules box (fixing centres 108,5 mm)



Descrizione Description

Info

€

□

□

Per 4 comandi a levetta  
 For 4 toggle controls

□ 44PCN04B  
 Bianco  
 White

1 1

Supporto da utilizzare  
 To be used with



44A04

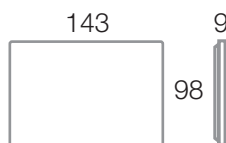

Scatole utilizzabili  
 Available boxes



2504

253X4

Pareti in muratura  
 Brickwork walls



254CGPR

254CG

253X4CG

Pareti in cartongesso  
 Hollow walls



Per la disponibilità contattare la rete commerciale  
 For availability please contact sales dept.



Disponibilità fino ad esaurimento scorte  
 Available until stock out



Prodotto per scatola rettangolare inglese  
 Product for British standard rectangular box



Prodotto per Export  
 For Export only

Placche "Vera 44" in Corian® per scatola tonda e quadrata  
 "Vera 44" Corian® front plates for round and square box

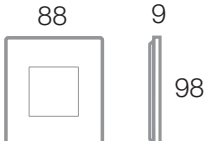
Descrizione Description		Info	€	□	□
		Per 2 comandi standard 44 For 2 S44 standard controls			
		<input type="checkbox"/> 44PCT22B Bianco White		1	1

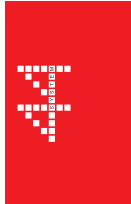

Sistema 45

Supporto da utilizzare  
 To be used with



44A02  
 44A02SG  
 44A02VT

Scatole utilizzabili  
 Available boxes



Pareti in muratura  
 Brickwork walls

Pareti in cartongesso  
 Hollow walls

Placche "Vera 44" in Corian® per scatola tonda e quadrata  
 "Vera 44" Corian® front plates for round and square box

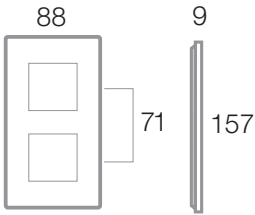
Descrizione Description		Info	€	□	□
		Per 4 (2+2) moduli standard 44 For 4 (2+2) S44 standard modules			
		<input type="checkbox"/> 44PCT24B Bianco White		1	1

Supporti accoppiabili  
 Frames that can be coupled



n° 2 44A02  
 n° 2 44A02SG  
 n° 2 44A02VT

Scatole  
 Boxes

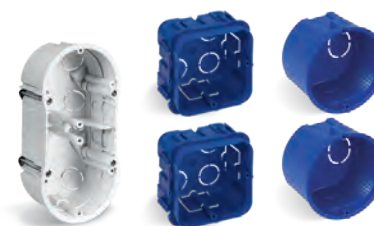

Standard Export

2502

2501



# Placche Corian®

## Corian® front plates



Placche "Vera 44" in Corian® per scatola tonda e quadrata  
 "Vera 44" Corian® front plates for round and square box

170

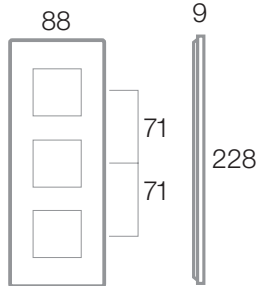

Descrizione Description

Info

€

□

□

Per 6 (2+2+2) moduli standard 44  
 For 6 (2+2+2) S44 standard modules

□ 44PCT26B	1	1
Bianco		
White		

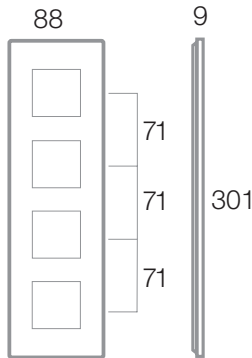

Descrizione Description

Info

€

□

□

Per 8 (2+2+2+2) moduli standard 44  
 For 8 (2+2+2+2) S44 standard modules

□ 44PCT28B	6	6
Bianco		
White		

Supporti accoppiabili  
 Frames that can be coupled



n° 3 44A02  
 n° 3 44A02SG  
 n° 3 44A02VT

Scatole  
 Boxes



2502      2501

Supporti accoppiabili  
 Frames that can be coupled



n° 4 44A02  
 n° 4 44A02SG  
 n° 4 44A02VT

Scatole  
 Boxes



2502      2501



Per la disponibilità contattare  
 la rete commerciale  
 For availability please contact  
 sales dept.



Disponibilità fino ad  
 esaurimento scorte  
 Available until stock out



Prodotto per scatola  
 rettangolare inglese  
 Product for British standard  
 rectangular box



Prodotto  
 per Export  
 For Export  
 only

**Placche "Vera 44" in Corian® per scatola 3 moduli (interasse 83,5 mm)**  
**"Vera 44" Corian® front plates for rectangular 3 modules box (fixing centres 83,5 mm)**

Descrizione Description	Info	€	<input type="checkbox"/>	<input type="checkbox"/>
 <p><b>Per 3 moduli standard 44</b> For 3 S44 standard modules</p> <p><input type="checkbox"/> <b>44PCN3B</b> Bianco White</p>	1	1		

Supporto da utilizzare  
To be used with

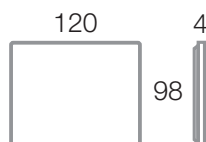

Scatole utilizzabili  
Available boxes



**Placche "Vera 44" in Corian® per scatola 4 moduli (interasse 108,5 mm)**  
**"Vera 44" Corian® front plates for rectangular 4 modules box (fixing centres 108,5 mm)**

Descrizione Description	Info	€	<input type="checkbox"/>	<input type="checkbox"/>
 <p><b>Per 4 moduli standard 44</b> For 4 S44 standard modules</p> <p><input type="checkbox"/> <b>44PCN4B</b> Bianco White</p>	1	1		

Supporto da utilizzare  
To be used with

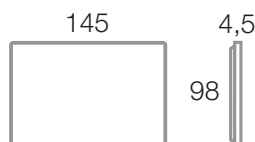

Scatole utilizzabili  
Available boxes

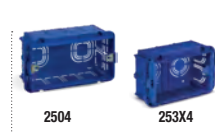

**Placche "Vera 44" in Corian® per scatola 7 moduli (interasse 158,5 mm)**  
**"Vera 44" Corian® front plates for rectangular 7 modules box (fixing centres 158,5 mm)**

Descrizione Description	Info	€	<input type="checkbox"/>	<input type="checkbox"/>
 <p><b>Per 7 moduli standard 44</b> For 7 S44 standard modules</p> <p><input type="checkbox"/> <b>44PCN7B</b> Bianco White</p>	1	1		

Supporto da utilizzare  
To be used with

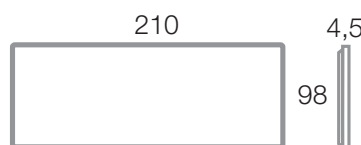

Scatole utilizzabili  
Available boxes



# Placche

## Front Plates

BREVETTO AVE n° 258 MODELLO COMUNITARIO  
AVE PATENT n° 258 EU MODEL



Design:  
L. Merletti

172

### I colori delle placche "Smart TOUCH 44" in METALLO per scatola rettangolare "Smart TOUCH 44" front plates colours for rectangular box



**44PSMTC3GTK**  
GRIGIO TEKLA  
finitura opaca  
*Frosted TEKLA grey*



**44PSMTC3AA**  
ACCIAIO ANTRACITE  
effetto spazzolato  
*Steel anthracite, brushed effect*

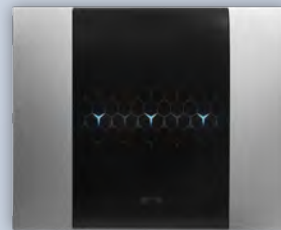

**44PSMTC3AS**  
ACCIAIO SATINATO  
effetto spazzolato  
*Satin steel, brushed effect*



**44PSMTC3B**  
BIANCO DOMUS  
finitura lucida  
*Clear DOMUS white*

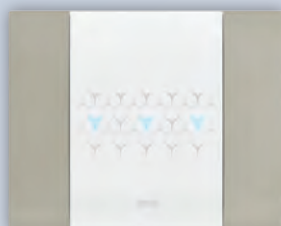

**44PSMTC3TO**  
TORTORA  
finitura opaca  
*Frosted dove grey*



**44PSMTC3BO**  
BIANCO  
finitura opaca  
*Frosted white*



### I colori delle placche "SMART NEW STYLE 44" in METALLO per scatola rettangolare "SMART NEW STYLE 44" front plates colours for rectangular box

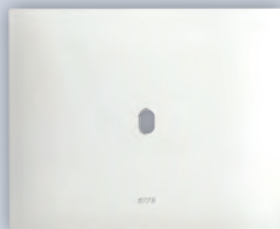

**44PSMN01BO**  
BIANCO  
finitura opaca  
*Frosted white*



**44PSMN01GTK**  
GRIGIO TEKLA  
finitura opaca  
*Frosted TEKLA grey*



**I colori delle placche "Smart 44" in METALLO per scatola rettangolare**  
*"Smart 44" front plates colours for rectangular box*



**44PSM3GTK**  
GRIGIO TEKLA  
finitura opaca  
*Frosted TEKLA grey*



**44PSM3AA**  
ACCIAIO ANTRACITE  
effetto spazzolato  
*Steel anthracite, brushed effect*



**44PSM3AS**  
ACCIAIO SATINATO  
effetto spazzolato  
*Satin steel, brushed effect*



**44PSM3B**  
BIANCO DOMUS  
finitura lucida  
*Clear DOMUS white*



**44PSM3AVR**  
AVORIO  
finitura lucida  
*Clear ivory*



**44PSM3TO**  
TORTORA  
finitura opaca  
*Frosted dove grey*



**44PSM3BO**  
BIANCO  
finitura opaca  
*Frosted white*



# Placche Metallo

## Metal front plates



Placche "Smart Touch 44" in metallo per scatola 3 moduli (interasse 83,5 mm)  
"Smart Touch 44" metal front plates for rectangular 3 modules box (fixing centres 83,5 mm)

174

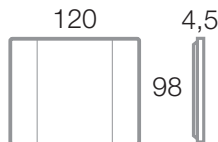

Supporto da utilizzare  
To be used with



44A03SM

Descrizione Description

Info

€

□

□

Fino a 6 (3+3) comandi "a scomparsa"  
Up to 6 (3+3) "hidden" controls

■ 44PSMTC3AA	1	1
Acciaio Antracite spazzolato Brushed steel anthracite		
■ 44PSMTC3AS	1	1
Acciaio satinato spazzolato Brushed satin steel		
□ 44PSMTC3B	1	1
Bianco finitura lucida Clear white		
□ 44PSMTC3BO	1	1
Bianco finitura opaca Frosted white		
■ 44PSMTC3GTK	1	1
Grigio TEKLA finitura opaca Frosted TEKLA grey		
■ 44PSMTC3TO	1	1
Tortora finitura opaca Frosted dove grey		



Nota: assicurarsi che la placca sia perfettamente aderente agli apparecchi di comando "a scomparsa"

Note: make sure that the front plate sticks perfectly to the "hidden" control devices

Placche "Smart Touch 44" in metallo per scatola 4 moduli (interasse 108,5 mm)  
"Smart Touch 44" metal front plates for rectangular 4 modules box (fixing centres 108,5 mm)

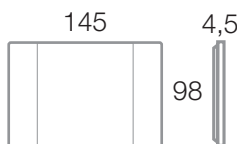

Supporto da utilizzare  
To be used with



44A04SM

Descrizione Description

Info

€

□

□

Fino a 4 comandi "a scomparsa"  
Up to 4 "hidden" controls

■ 44PSMTC4AA	1	1
Acciaio Antracite spazzolato Brushed steel anthracite		
■ 44PSMTC4AS	1	1
Acciaio satinato spazzolato Brushed satin steel		
□ 44PSMTC4B	1	1
Bianco finitura lucida Clear white		
□ 44PSMTC4BO	1	1
Bianco finitura opaca Frosted white		
■ 44PSMTC4GTK	1	1
Grigio TEKLA finitura opaca Frosted TEKLA grey		
■ 44PSMTC4TO	1	1
Tortora finitura opaca Frosted dove grey		



Nota: assicurarsi che la placca sia perfettamente aderente agli apparecchi di comando "a scomparsa"

Note: make sure that the front plate sticks perfectly to the "hidden" control devices



Per la disponibilità contattare la rete commerciale  
For availability please contact sales dept.



Disponibilità fino ad esaurimento scorte  
Available until stock out



Prodotto per scatola rettangolare inglese  
Product for British standard rectangular box



Prodotto per Export  
For Export only

Placche "Smart Touch 44" in metallo a scivolo per scatola 3 moduli (interasse 83,5 mm)  
 "Smart Touch 44" sliding metal front plates for rectangular 3 modules box (fixing centres 83,5 mm)

Descrizione Description	Info	€	□	□	175
-------------------------	------	---	---	---	-----

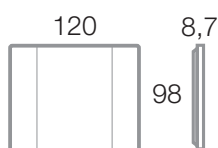

Fino a 6 (3+3) comandi "a scomparsa"  
 Up to 6 (3+3) "hidden" controls

<input type="checkbox"/> <b>44PSMTCS3B</b> Bianco finitura lucida Clear white	1	1
<input checked="" type="checkbox"/> <b>44PSMTCS3GTK</b> Grigio TEKLA finitura opaca Frosted TEKLA grey	1	1

- Note:**
- ✓ Da utilizzare solo con supporti speciali 44ASMTC03...
  - ✓ Simbolo spina non illuminabile, indicatori di direzione illuminati dall'inserto a led fornito in dotazione con il supporto.
  - ✓ Utilizzabile con tutti i prodotti 1, 2 o 3 moduli standard Sistema 44 ad esclusione dei codici sotto riportati.
- Note:**
- ✓ To be used only with special frame 44ASMTC03...
  - ✓ "plug" symbol not lightable, direction indicators lightable by led supplied with the frame.
  - ✓ It can be used with all the system 44 standard products 1-2 or 3 modules with the exception of the codes shown below.

Supporto da utilizzare  
 To be used with



44ASMTC03GTK



44ASMTC03B

Scatole utilizzabili  
 Available boxes



Pareti in muratura  
 Brickwork walls



Pareti in cartongesso  
 Hollow walls

Prodotti non installabili con placche "a Scivolamento" Products that can not be installed with sliding front plates



44..052X6  
 44..052X10  
 44..052X16

44..062X6  
 44..062X10  
 44..062X16

441083/2  
 442083  
 AF44..099

442076

442048AE

44..048

44..048D

44..085

44..085SW

Prodotti non installabili con placche "a Scivolamento" in scatole per pareti cave Products that can not be installed with sliding front plates in boxes for hollow walls



44..051  
 44..052  
 44..053  
 44..054



44..033RS

No

No



253CG



253X4CG

Scatole per pareti cave  
 Boxes for hollow walls





# Placche Metallo

Metal front plates



Placche "New Style Smart 44" in metallo per scatola 3 moduli (interasse 83,5 mm)  
"New Style Smart 44" metal front plates for rectangular 3 modules box (fixing centres 83,5 mm)

176



### Descrizione Description

Info

€



Per 1 comando a levetta  
For 1 toggle control

□ 44PSMN01B0

Bianco  
White



1

1

■ 44PSMN01GTK

Grigio Tekla  
Tekla grey



1

1



### Descrizione Description

Info

€



Per 2 comandi a levetta  
For 2 toggle controls

□ 44PSMN02B0

Bianco  
White



1

1

■ 44PSMN02GTK

Grigio Tekla  
Tekla grey



1

1



### Descrizione Description

Info

€



Per 3 comandi a levetta  
For 3 toggle controls

□ 44PSMN03B0

Bianco  
White



1

1

■ 44PSMN03GTK

Grigio Tekla  
Tekla grey



1

1

Supporto da utilizzare  
To be used with



44A03SM

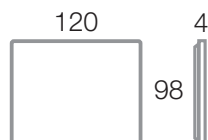

Scatole utilizzabili  
Available boxes



2503MG

253X4

Pareti in muratura  
Brickwork walls



253CGPR

253CG

253X4CG

Pareti in cartongesso  
Hollow walls



Per la disponibilità contattare  
la rete commerciale  
For availability please contact  
sales dept.



Disponibilità fino ad  
esaurimento scorte  
Available until stock out











Prodotto per scatola  
rettangolare inglese  
Product for British standard  
rectangular box

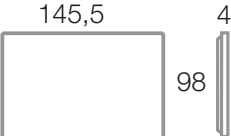









Prodotto  
per Export  
For Export  
only

**Placche "New Style Smart 44" in metallo per scatola 4 moduli (interasse 108,5 mm)**  
**"Smart New Style Smart 44" metal front plates for rectangular 4 modules box (fixing centres 108,5 mm)**

		Descrizione Description	Info	€	<input type="checkbox"/>	<input type="checkbox"/>		
	<b>Per 4 comandi a levetta</b> <b>For 4 toggle controls</b>							
	<input type="checkbox"/> <b>44PSMN04B0</b> Bianco White			1	1			
	<input checked="" type="checkbox"/> <b>44PSMN04GTK</b> Grigio Tekla Tekla grey			1	1			
	<b>Per 1 comando a levetta e 1 presa di corrente</b> <b>For 1 toggle controls</b>							
	<input type="checkbox"/> <b>44PSMN9002B0</b> Bianco White			1	1			
	<input checked="" type="checkbox"/> <b>44PSMN9002GTK</b> Grigio Tekla Tekla grey			1	1			
<b>Supporto da utilizzare</b> <b>To be used with</b>			<b>Scatole utilizzabili</b> <b>Available boxes</b>					
<b>44A04SM</b>			Pareti in muratura <i>Brickwork walls</i>			Pareti in cartongesso <i>Hollow walls</i>		

Sistema 45

**Placche "New Style Smart 44" in metallo per scatola 3 moduli (interasse 83,5 mm)**  
**"New Style Smart 44" metal front plates for rectangular 3 modules box (fixing centres 83,5 mm)**

		Descrizione Description	Info	€	<input type="checkbox"/>	<input type="checkbox"/>		
	<b>Per 1 presa di corrente</b> <b>For 1 socket outlet</b>							
	<input type="checkbox"/> <b>44PSMN90B0</b> Bianco White			1	1			
	<input checked="" type="checkbox"/> <b>44PSMN90GTK</b> Grigio Tekla Tekla grey			1	1			
	<b>Per 1 comando a levetta e 1 presa di corrente</b> <b>For 1 toggle controls</b>							
	<input type="checkbox"/> <b>44PSMN902B0</b> Bianco White			1	1			
	<input checked="" type="checkbox"/> <b>44PSMN902GTK</b> Grigio Tekla Tekla grey			1	1			
<b>Supporto da utilizzare</b> <b>To be used with</b>			<b>Scatole utilizzabili</b> <b>Available boxes</b>					
<b>44A03SM</b>			Pareti in muratura <i>Brickwork walls</i>			Pareti in cartongesso <i>Hollow walls</i>		

Le dimensioni, salvo diversamente specificato, sono in mm  
 Dimensions, except where otherwise specified, are in mm

Imballo Minimo pcs  
 Min. Packaging pcs

Imballo Standard pcs  
 Std. Packaging pcs



# Placche Metallo

## Metal front plates



Placche "Smart 44" in metallo per scatola 3 moduli (interasse 83,5 mm)  
"Smart 44" metal front plates for rectangular 3 modules box (fixing centres 83,5 mm)

178

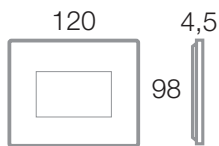

Supporto da utilizzare  
To be used with



44A03SM

Descrizione Description

Info

€



Per 3 moduli standard S44  
For 3 modules standard for S44

■ <b>44PSM3AA</b> Acciaio Antracite spazzolato Brushed steel anthracite	1	1
■ <b>44PSM3AS</b> Acciaio satinato spazzolato Brushed satin steel	1	1
■ <b>44PSM3AVR</b> Avorio finitura lucida Clear ivory	1	1
□ <b>44PSM3B</b> Bianco finitura lucida Clear white	1	1
□ <b>44PSM3BO</b> Bianco finitura opaca Frosted white	1	1
■ <b>44PSM3GTK</b> Grigio TEKLA finitura opaca Frosted TEKLA grey	1	1
■ <b>44PSM3TO</b> Tortora finitura opaca Frosted dove grey	1	1

Placche "Smart 44" in metallo per scatola 4 moduli (interasse 108,5 mm)  
"Smart 44" metal front plates for rectangular 4 modules box (fixing centres 108,5 mm)

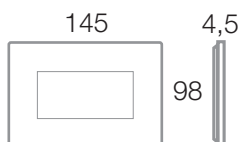

Supporto da utilizzare  
To be used with



44A04SM

Descrizione Description

Info

€



Per 4 moduli standard S44  
For 4 modules standard for S44

■ <b>44PSM4AA</b> Acciaio Antracite spazzolato Brushed steel anthracite	1	1
■ <b>44PSM4AS</b> Acciaio satinato spazzolato Brushed satin steel	1	1
■ <b>44PSM4AVR</b> Avorio finitura lucida Clear ivory	1	1
□ <b>44PSM4B</b> Bianco finitura lucida Clear white	1	1
□ <b>44PSM4BO</b> Bianco finitura opaca Frosted white	1	1
■ <b>44PSM4GTK</b> Grigio TEKLA finitura opaca Frosted TEKLA grey	1	1
■ <b>44PSM4TO</b> Tortora finitura opaca Frosted dove grey	1	1



Per la disponibilità contattare la rete commerciale  
For availability please contact sales dept.



Disponibilità fino ad esaurimento scorte  
Available until stock out



Prodotto per scatola rettangolare inglese  
Product for British standard rectangular box



Prodotto per Export  
For Export only

Placche "Smart 44" in metallo per scatola 7 moduli (interasse 158,5 mm)  
 "Smart 44" metal front plates for rectangular 7 modules box (fixing centres 158,5 mm)

Descrizione Description	Info	€	□	□	179
<b>Per 7 moduli standard S44</b> <i>For 7 modules standard for S44</i>					
■ <b>44PSM7AA</b> Acciaio Antracite spazzolato <i>Brushed steel anthracite</i>			1	1	
■ <b>44PSM7AS</b> Acciaio satinato spazzolato <i>Brushed satin steel</i>			1	1	
■ <b>44PSM7AVR</b> Avorio finitura lucida <i>Clear ivory</i>			1	1	
□ <b>44PSM7B</b> Bianco finitura lucida <i>Clear white</i>			1	1	
□ <b>44PSM7BO</b> Bianco finitura opaca <i>Frosted white</i>			1	1	
■ <b>44PSM7GTK</b> Grigio TEKLA finitura opaca <i>Frosted TEKLA grey</i>			1	1	
■ <b>44PSM7TO</b> Tortora finitura opaca <i>Frosted dove grey</i>			1	1	

Sistema 45

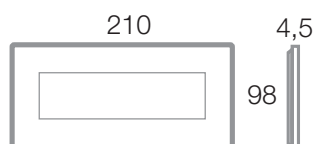

Supporto da utilizzare  
 To be used with



44A07SM

Scatole utilizzabili  
 Available boxes



Pareti in muratura *Brickwork walls*



Pareti in cartongesso *Hollow walls*

Le dimensioni, salvo diversamente specificato, sono in mm  
 Dimensions, except where otherwise specified, are in mm

□ Imballo Minimo pcs  
 Min. Packaging pcs

□ Imballo Standard pcs  
 Std. Packaging pcs

# Placche

## Front Plates

Design:  
L. Merletti

180

### I colori delle placche "Ave Touch" ALLUMINIO

*AVE Touch Aluminium front plates colours*

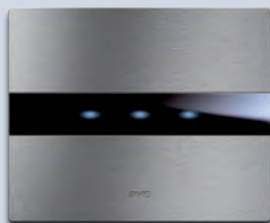

**44PATC3ALS**  
Alluminio naturale spazzolato  
*Natural brushed aluminium*



**44PATC3ANS**  
Alluminio antracite spazzolato  
*Anthracite brushed aluminium*

### I colori delle placche VERA 44 ALLUMINIO

*Vera 44 Aluminium front plates colours*



**44PA3ALS/FM**  
Alluminio naturale spazzolato  
*Natural brushed aluminium*



**44PA3ANS/FM**  
Alluminio antracite spazzolato  
*Anthracite brushed aluminium*

### I colori delle placche a levetta "New Style" in alluminio (H96 mm)

*The colors of the "New Style" aluminum toggle front plates (H96 mm)*



**44PAN03ALS**  
Alluminio naturale spazzolato  
*Natural brushed aluminium*



**44PAN03ANS**  
Alluminio antracite spazzolato  
*Anthracite brushed aluminium*



**44PA3ALS**  
Alluminio naturale spazzolato  
*Natural brushed aluminium*



**44PA3ANS**  
Alluminio antracite spazzolato  
*Anthracite brushed aluminium*



**I colori delle placche a levetta "New Style" in alluminio (H98 mm)**  
*The colors of the "New Style" aluminum toggle front plates (H98 mm)*



**44PANQ03BRZ**  
Alluminio Bronzo effetto spazzolato  
*Brushed bronze effect aluminium*

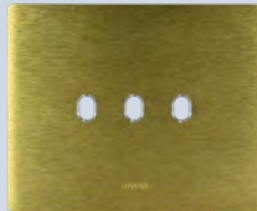

**44PANQ03ORO**  
Alluminio oro effetto spazzolato  
*Gold brushed effect aluminium*

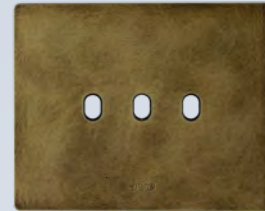

**44PANQ03BAN**  
Alluminio bronzo anticato  
*Antiqued bronze aluminium*

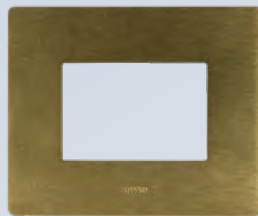

**44PAQ3BRZ**  
Alluminio Bronzo effetto spazzolato  
*Brushed bronze effect aluminium*



**44PANQ3ORO**  
Alluminio oro effetto spazzolato  
*Gold brushed effect aluminium*



**44PANQ3BAN**  
Alluminio bronzo anticato  
*Antiqued bronze aluminium*

**SENZA CORNICETTA DI FINITURA**  
*WITHOUT FINISHING FRAME*





# Placche Alluminio

Aluminium front plates



Placche "Ave Touch" in alluminio per scatola tonda o quadrata  
"Ave Touch" aluminium front plates for round or square box

182



Descrizione Description

Info

€

□

□

Fino a 2 comandi "a scomparsa"  
Up to 2 "hidden" controls

■ 44PATC22ALS	1	1
Alluminio naturale spazzolato Natural brushed aluminium		
■ 44PATC22ANS	1	1
Alluminio antracite spazzolato Anthracite brushed aluminium		

**Nota:** Assicurarsi che la placca sia perfettamente aderente agli apparecchi di comando "a scomparsa".

Completare con tappo copriferro 442TC13R i moduli non utilizzati.

**Note:** Make sure that the front plate sticks perfectly to the "hidden" control devices.  
Use the 442TC13R blank insert for empty modules

Supporto da utilizzare  
To be used with



44A02  
44A02SG  
44A02VT

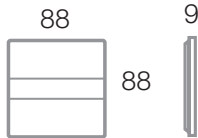

Scatole utilizzabili  
Available boxes



Placche "Ave Touch" in alluminio per scatola 3 moduli (interasse 83,5 mm)  
"Ave Touch" aluminium front plates for 3 modules box (fixing centres 83,5 mm)

Descrizione Description

Info

€

□

□



Fino a 3 comandi "a scomparsa"  
Up to 3 "hidden" controls

■ 44PATC3ALS	1	1
Alluminio naturale spazzolato Natural brushed aluminium		
■ 44PATC3ANS	1	1
Alluminio antracite spazzolato Anthracite brushed aluminium		

**Nota:** Assicurarsi che la placca sia perfettamente aderente agli apparecchi di comando "a scomparsa".

Completare con tappo copriferro 442TC13R i moduli non utilizzati.

**Note:** Make sure that the front plate sticks perfectly to the "hidden" control devices.  
Use the 442TC13R blank insert for empty modules

Supporto da utilizzare  
To be used with



44A03

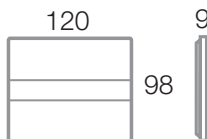

Scatole utilizzabili  
Available boxes

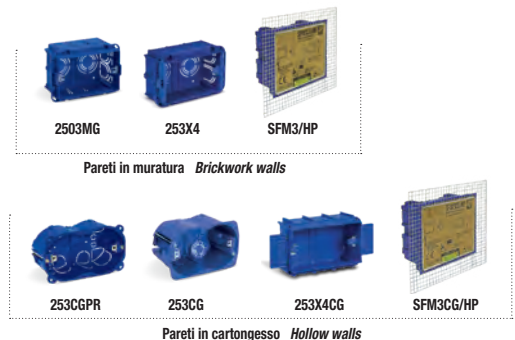

Per la disponibilità contattare la rete commerciale  
For availability please contact sales dept.



Disponibilità fino ad esaurimento scorte  
Available until stock out



Prodotto per scatola rettangolare inglese  
Product for British standard rectangular box



Prodotto per Export  
For Export only

Placche "Ave Touch" in alluminio per scatola 4 moduli (interasse 108,5 mm)  
 "Ave Touch" aluminium front plates for 4 modules box (fixing centres 108,5 mm)

Descrizione Description	Info	€	<input type="checkbox"/>	<input type="checkbox"/>	183
<b>Fino a 4 comandi "a scomparsa"</b> <i>Up to 4 "hidden" controls</i>					
■ <b>44PATC4ALS</b> Alluminio naturale spazzolato <i>Natural brushed aluminium</i>	1	1			
■ <b>44PATC4ANS</b> Alluminio antracite spazzolato <i>Anthracite brushed aluminium</i>	1	1			
<p><b>Nota:</b> Assicurarsi che la placca sia perfettamente aderente agli apparecchi di comando "a scomparsa".                      Completare con tappo copriforo 442TC13R i moduli non utilizzati.</p> <p><b>Note:</b> Make sure that the front plate sticks perfectly to the "hidden" control devices.                      Use the 442TC13R blank insert for empty modules</p>					

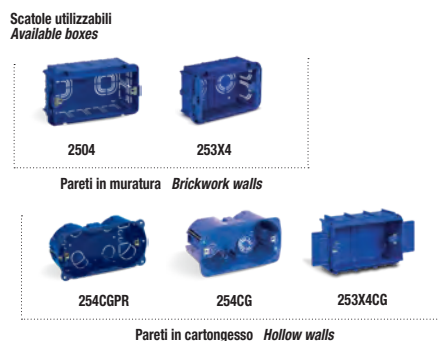
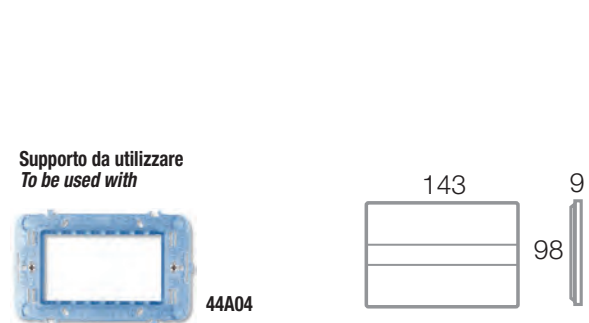

Placche "Ave Touch" in alluminio per scatola 6-7 moduli (interasse 158,5 mm)  
 "Ave Touch" aluminium front plates for 6-7 modules box (fixing centres 158,5 mm)

Descrizione Description	Info	€	<input type="checkbox"/>	<input type="checkbox"/>
<b>Fino a 7 comandi "a scomparsa"</b> <i>Up to 7 "hidden" controls</i>				
■ <b>44PATC7ALS</b> Alluminio naturale spazzolato <i>Natural brushed aluminium</i>	1	1		
■ <b>44PATC7ANS</b> Alluminio antracite spazzolato <i>Anthracite brushed aluminium</i>	1	1		
<p><b>Nota:</b> Assicurarsi che la placca sia perfettamente aderente agli apparecchi di comando "a scomparsa".                      Completare con tappo copriforo 442TC13R i moduli non utilizzati.</p> <p><b>Note:</b> Make sure that the front plate sticks perfectly to the "hidden" control devices.                      Use the 442TC13R blank insert for empty modules</p>				

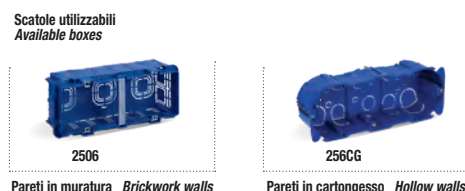
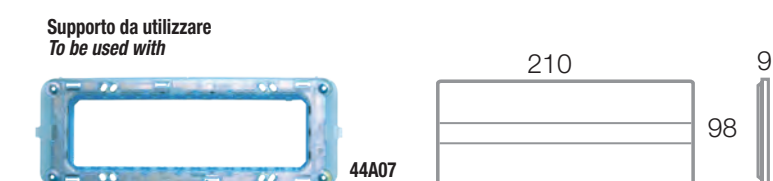





# Placche Alluminio

Aluminium front plates



Placche "Ave Touch" in alluminio per scatola 3 moduli (interasse 83,5 mm)  
"Ave Touch" aluminium front plates for 3 modules box (fixing centres 83,5 mm)

184

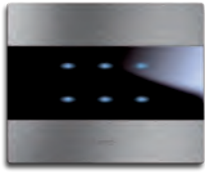

Descrizione Description

Info

€

□

□

Fino a 6 (3+3) comandi "a scomparsa"  
Up to 6 (3+3) "hidden" controls

■ 44PATC16ALS

1 1

Alluminio naturale spazzolato  
Natural brushed aluminium

■ 44PATC16ANS

1 1

Alluminio antracite spazzolato  
Anthracite brushed aluminium

**Nota:** Assicurarsi che la placca sia perfettamente aderente agli apparecchi di comando "a scomparsa".

Completare con tappo copriforo 442TC13R i moduli non utilizzati.

**Note:** Make sure that the front plate sticks perfectly to the "hidden" control devices.  
Use the 442TC13R blank insert for empty modules



Descrizione Description

Info

€

□

□

Per 1 modulo pulsante "a scomparsa" con targhetta portanome  
For 1 "hidden" push-button module with name tag

■ 44PATC88ALS

1 1

Alluminio naturale spazzolato  
Natural brushed aluminium

■ 44PATC88ANS

1 1

Alluminio antracite spazzolato  
Anthracite brushed aluminium

**Nota:** assicurarsi che la placca sia perfettamente aderente agli apparecchi di comando "a scomparsa"

**Note:** make sure that the front plate sticks perfectly to the "hidden" control devices

Supporto da utilizzare  
To be used with



44A03

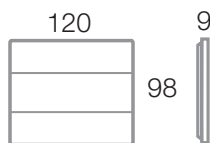

Scatole utilizzabili  
Available boxes



2503MG

253X4

SFM3/HP

Pareti in muratura Brickwork walls

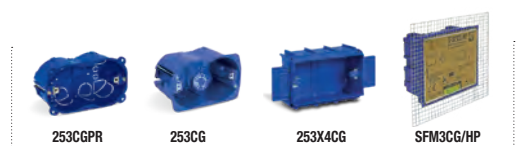

253CGPR

253CG

253X4CG

SFM3CG/HP

Pareti in cartongesso Hollow walls



Per la disponibilità contattare la rete commerciale  
For availability please contact sales dept.



Disponibilità fino ad esaurimento scorte  
Available until stock out



Prodotto per scatola rettangolare inglese  
Product for British standard rectangular box



Prodotto per Export  
For Export only

**Placche "Ave Touch" in alluminio a scivolo per scatola 3 moduli (interasse 83,5 mm)**  
**"Ave Touch" sliding aluminium front plates for 3 modules box (fixing centres 83,5 mm)**

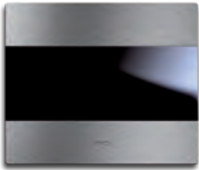
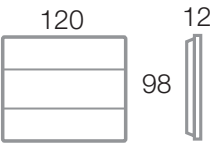
		Descrizione <i>Description</i>	Info	€	□	□
		<b>Per 3 moduli standard Sistema 44</b> <i>For 3 standard S44 moulded</i>				
		■ <b>44PATCS3ALS</b> Placca a scivolamento per copertura 3 mod. S44 simbolo "SPINA" - Alluminio naturale spazzolato <i>Sliding front plate for covering 3 mod. S44 "PLUG" symbol - Natural brushed aluminium</i>	1	1		
		■ <b>44PATCS3ANS</b> Placca a scivolamento per copertura 3 mod. S44 simbolo "SPINA" - Alluminio antracite spazzolato <i>Sliding front plate for covering 3 mod. S44 "PLUG" symbol - Anthracite brushed aluminium</i>	1	1		
		■ <b>44PATCN3ALS</b> Placca a scivolamento per copertura 3 mod. S44 Alluminio naturale spazzolato <i>Sliding front plate for covering 3 mod. S44 Natural brushed aluminium</i>	1	1		
		■ <b>44PATCN3ANS</b> Placca a scivolamento per copertura 3 mod. S44 Alluminio antracite spazzolato <i>Sliding front plate for covering 3 mod. S44 Anthracite brushed aluminium</i>	1	1		

**Supporti da utilizzare**  
*To be used with*



44ATC03ALS

44ATC03GSL

**Note:** ✓ da utilizzare solo con supporti speciali 44ATC03ALS o 44ATC03GSL  
 ✓ utilizzabile con tutti i prodotti 1, 2 o 3 moduli standard Sistema 44 ad esclusione dei codici sotto riportati.

**Note:** ✓ to be used only with special frame 44ATC03ALS or 44ATC03GSL  
 ✓ It can be used with all the system 44 standard products 1-2 or 3 modules with the exception of the codes shown below.

**Scatole utilizzabili**  
*Available boxes*

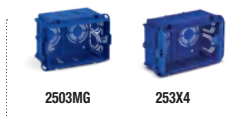

2503MG

253X4

Pareti in muratura *Brickwork walls*



253CGPR

253CG

253X4CG

Pareti in cartongesso *Hollow walls*

**Prodotti non installabili con placche "a Scivolamento" Products that can not be installed with sliding front plates**



44..052X6  
44..052X10  
44..052X16

44..062X6  
44..062X10  
44..062X16

441083/2  
442083  
AF44..099

442076

442048AE

44..048

44..048D

44..085

44..085SW

**Prodotti non installabili con placche "a Scivolamento" in scatole per pareti cave Products that can not be installed with sliding front plates in boxes for hollow walls**

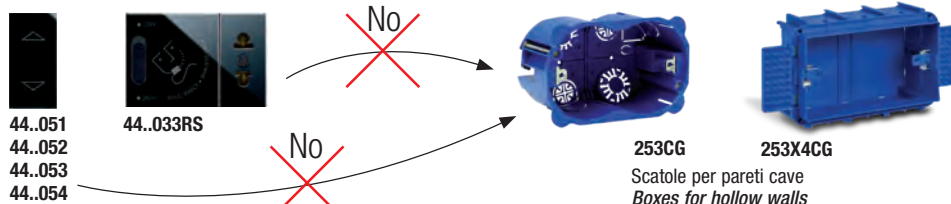

44..051  
44..052  
44..053  
44..054

44..033RS

253CG

253X4CG

Scatole per pareti cave  
*Boxes for hollow walls*

Le dimensioni, salvo diversamente specificato, sono in mm  
Dimensions, except where otherwise specified, are in mm

□ Imballo Minimo pcs  
Min. Packaging pcs

□ Imballo Standard pcs  
Std. Packaging pcs

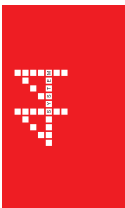



# Placche Alluminio

## Aluminium front plates



### Placche "Ave Touch" in alluminio per scatola 3 moduli (interasse 83,5 mm)

"Ave Touch" aluminium front plates for 3 modules box (fixing centres 83,5 mm)

186

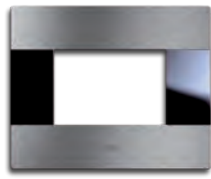

#### Descrizione Description

Info

€

□

□

**3 moduli standard S44 - anche per installazioni "filo muro"**  
**3 modules standard for S44 - also for "wall-lined" installations**

■ **44PA3ALS/FM** 1 1

Alluminio naturale spazzolato  
Natural brushed aluminium

■ **44PA3ANS/FM** 1 1

Alluminio antracite spazzolato  
Anthracite brushed aluminium

Supporto da utilizzare  
To be used with



44A03

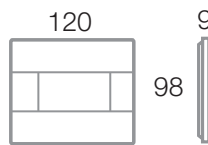

**Nota:** se le placche vengono utilizzate con i lettori di camera del sistema alberghiero (cod. 44..GA01-M e 44..GA30-M) è necessario richiedere una placca "speciale". Per maggiori informazioni rivolgeti al funzionario tecnico commerciale della tua zona  
**Note:** If the front plate is used with room readers of hotel management system (code 44..GA01-M or 44..GA30-M) is necessary to order the "special" front plate. For more information contact our area manager

### Placche "Ave Touch" in alluminio per scatola 4 moduli (interasse 108,5 mm)

"Ave Touch" aluminium front plates for 4 modules box (fixing centres 108,5 mm)

#### Descrizione Description

Info

€

□

□

**4 moduli standard S44**  
**4 modules standard for S44**

■ **44PA4ALS/FM** 1 1

Alluminio naturale spazzolato  
Natural brushed aluminium

■ **44PA4ANS/FM** 1 1

Alluminio antracite spazzolato  
Anthracite brushed aluminium

Supporto da utilizzare  
To be used with



44A04

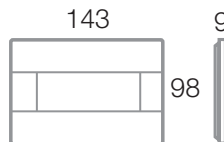

### Placche "Ave Touch" in alluminio per scatola 6-7 moduli (interasse 158,5 mm)

"Ave Touch" aluminium front plates for 6-7 modules box (fixing centres 158,5 mm)

#### Descrizione Description

Info

€

□

□

**7 moduli standard S44**  
**7 modules standard for S44**

■ **44PA7ALS/FM** 1 1

Alluminio naturale spazzolato  
Natural brushed aluminium

■ **44PA7ANS/FM** 1 1

Alluminio antracite spazzolato  
Anthracite brushed aluminium

Supporto da utilizzare  
To be used with



44A07

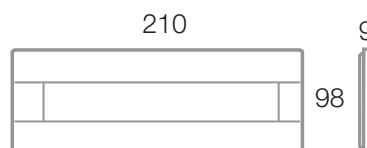

Per la disponibilità contattare la rete commerciale  
For availability please contact sales dept.



Disponibilità fino ad esaurimento scorte  
Available until stock out



Prodotto per scatola rettangolare inglese  
Product for British standard rectangular box



Prodotto per Export  
For Export only

Placche "New Style" in alluminio per scatola tonda o quadrata  
 "New Style" aluminium front plates for round or square box



Descrizione Description	Info	€	<input type="checkbox"/>	<input type="checkbox"/>
<b>Per 1 comando a levetta</b> <i>For 1 toggle control</i>				
■ <b>44PANT21ALS</b> Alluminio naturale spazzolato <i>Natural brushed aluminium</i>	1	1		
■ <b>44PANT21ANS</b> Alluminio antracite spazzolato <i>Anthracite brushed aluminium</i>	1	1		
<b>Nota: il supporto (44A02 - 44A02SG - 44A02VT) va completato con copriforo 442TC13R</b> <b>Note: the frame (44A02 - 44A02SG - 44A02VT) must be completed with 442TC13R blank insert</b>				



Descrizione Description	Info	€	<input type="checkbox"/>	<input type="checkbox"/>
<b>Per 2 comandi a levetta</b> <i>For 2 toggle controls</i>				
■ <b>44PANT22ALS</b> Alluminio naturale spazzolato <i>Natural brushed aluminium</i>	1	1		
■ <b>44PANT22ANS</b> Alluminio antracite spazzolato <i>Anthracite brushed aluminium</i>	1	1		



Descrizione Description	Info	€	<input type="checkbox"/>	<input type="checkbox"/>
<b>Per 1 presa di corrente</b> <i>For 1 socket outlet</i>				
■ <b>44PANT90ALS</b> Alluminio naturale spazzolato - fornita con n. 1 ghiera in plastica cromata <i>Natural brushed aluminium - supplied with 1 ring plastic chrome ring</i>	1	1		
■ <b>44PANT90ANS</b> Alluminio antracite spazzolato - fornita con n. 1 in plastica cromata <i>Anthracite brushed aluminium - supplied with 1 ring plastic chrome</i>	1	1		

Supporto da utilizzare  
To be used with

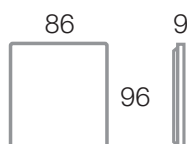

Scatole utilizzabili  
Available boxes





# Placche Alluminio

## Aluminium front plates

Placche "New Style" in alluminio per scatola 3 moduli (interasse 83,5 mm)  
"New Style" aluminium front plates for 3 modules box (fixing centres 83,5 mm)



188

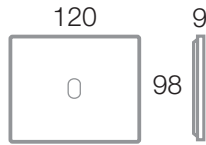

### Descrizione Description

Info

€

□

□

Per 1 comando a levetta  
For 1 toggle control

#### ■ 44PANQ01BAN

Bronzo anticato  
Antiqued bronze



1 1

#### ■ 44PANQ01BRZ

Bronzo effetto spazzolato  
Brushed bronze effect



1 1

#### ■ 44PANQ01ORO

Oro effetto spazzolato  
Gold brushed effect



1 1

Supporto da utilizzare  
To be used with



44A03

da completare con copriforo 442TC13R  
to be used with 442TC13R blank insert

Scatole utilizzabili  
Available boxes



2503MG

253X4

Pareti in muratura  
Brickwork walls



253CGPR

253CG

253X4CG

Pareti in cartongesso  
Hollow walls

### Descrizione Description

Info

€

□

□

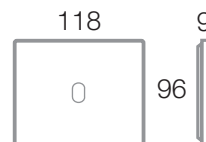

Per 1 comando a levetta  
For 1 toggle control

#### ■ 44PAN01ALS

Alluminio naturale spazzolato  
Natural brushed aluminium

1 1

#### ■ 44PAN01ANS

Alluminio antracite spazzolato  
Anthracite brushed aluminium

1 1

Supporto da utilizzare  
To be used with



44A03

da completare con copriforo 442TC13R  
to be used with 442TC13R blank insert

Scatole utilizzabili  
Available boxes



2503MG

253X4

Pareti in muratura  
Brickwork walls



253CGPR

253CG

253X4CG

Pareti in cartongesso  
Hollow walls



Per la disponibilità contattare  
la rete commerciale  
For availability please contact  
sales dept.



Disponibilità fino ad  
esaurimento scorte  
Available until stock out



Prodotto per scatola  
rettangolare inglese  
Product for British standard  
rectangular box



Prodotto  
per Export  
For Export  
only

Placche "New Style" in alluminio per scatola 3 moduli (interasse 83,5 mm)  
 "New Style" aluminium front plates for 3 modules box (fixing centres 83,5 mm)

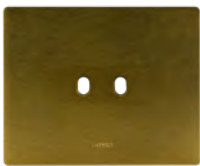
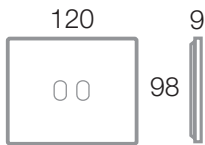
Descrizione Description		Info	€	<input type="checkbox"/>	<input type="checkbox"/>	189
 	<b>Per 2 comandi a levetta</b> <b>For 2 toggle controls</b>					
	<b>44PANQ02BAN</b> Bronzo anticato <i>Antiqued bronze</i>			1	1	
	<b>44PANQ02BRZ</b> Bronzo effetto spazzolato <i>Brushed bronze effect</i>			1	1	
<b>44PANQ02ORO</b> Oro effetto spazzolato <i>Gold brushed effect</i>			1	1		





Supporto da utilizzare  
To be used with

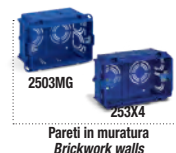

da completare con copriforo 442TC13R  
to be used with 442TC13R blank insert

Scatole utilizzabili  
Available boxes

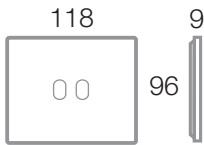

Descrizione Description		Info	€	<input type="checkbox"/>	<input type="checkbox"/>	
 	<b>Per 2 comandi a levetta</b> <b>For 2 toggle controls</b>					
	<b>44PAN02ALS</b> Alluminio naturale spazzolato <i>Natural brushed aluminium</i>			1	1	
	<b>44PAN02ANS</b> Alluminio antracite spazzolato <i>Anthracite brushed aluminium</i>			1	1	

Supporto da utilizzare  
To be used with



da completare con copriforo 442TC13R  
to be used with 442TC13R blank insert

Scatole utilizzabili  
Available boxes





# Placche Alluminio

## Aluminium front plates

Placche "New Style" in alluminio per scatola 3 moduli (interasse 83,5 mm)  
"New Style" aluminium front plates for 3 modules box (fixing centres 83,5 mm)



190

Descrizione Description

Info

€

□

□

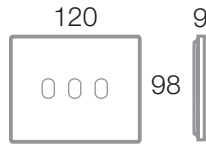
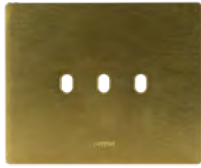

Per 3 comandi a levetta  
For 3 toggle controls

■ 44PANQ03BAN

Bronzo anticato

Antiqued bronze



1 1

■ 44PANQ03BRZ

Bronzo effetto spazzolato

Brushed bronze effect



1 1

■ 44PANQ03ORO

Oro effetto spazzolato

Gold brushed effect



1 1

Supporto da utilizzare  
To be used with



44A03

Scatole utilizzabili  
Available boxes

2503MG



253X4



Pareti in muratura  
Brickwork walls

253CGPR



253CG



253X4CG



Pareti in cartongesso  
Hollow walls

Descrizione Description

Info

€

□

□

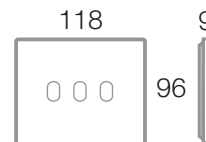

Per 3 comandi a levetta  
For 3 toggle controls

■ 44PAN03ALS

Alluminio naturale spazzolato

Natural brushed aluminium

1 1

■ 44PAN03ANS

Alluminio antracite spazzolato

Anthracite brushed aluminium

1 1

Supporto da utilizzare  
To be used with



44A03

Scatole utilizzabili  
Available boxes

2503MG



253X4



Pareti in muratura  
Brickwork walls

253CGPR



253CG



Pareti in cartongesso  
Hollow walls



Per la disponibilità contattare  
la rete commerciale  
For availability please contact  
sales dept.



Disponibilità fino ad  
esaurimento scorte  
Available until stock out



Prodotto per scatola  
rettangolare inglese  
Product for British standard  
rectangular box



Prodotto  
per Export  
For Export  
only

Placche "New Style" in alluminio per scatola 4 moduli (interasse 108,5 mm)  
 "New Style" aluminium front plates for 4 modules box (fixing centres 108,5 mm)

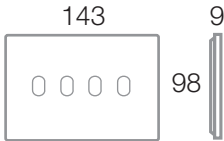
Descrizione Description		Info	€	<input type="checkbox"/>	<input type="checkbox"/>
 					
<b>Per 4 comandi a levetta</b> <b>For 4 toggle controls</b>					
■ 44PANQ04BAN	Bronzo anticato Antiqued bronze		1	1	
■ 44PANQ04BRZ	Bronzo effetto spazzolato Brushed bronze effect		1	1	
■ 44PANQ04ORO	Oro effetto spazzolato Gold brushed effect		1	1	

Sistema 45

Supporto da utilizzare  
To be used with



Scatole utilizzabili  
Available boxes

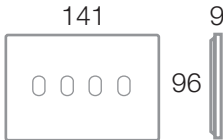

Descrizione Description		Info	€	<input type="checkbox"/>	<input type="checkbox"/>
 					
<b>Per 4 comandi a levetta</b> <b>For 4 toggle controls</b>					
■ 44PAN04ALS	Alluminio naturale spazzolato Natural brushed aluminium		1	1	
■ 44PAN04ANS	Alluminio antracite spazzolato Anthracite brushed aluminium		1	1	

Supporto da utilizzare  
To be used with



Scatole utilizzabili  
Available boxes

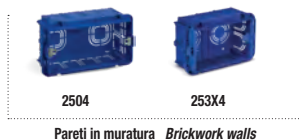





# Placche Alluminio

## Aluminium front plates

Placche "New Style" in alluminio per scatola 3 moduli (interasse 83,5 mm)  
"New Style" aluminium front plates for 3 modules box (fixing centres 83,5 mm)



192

Descrizione Description

Info

€

□

□

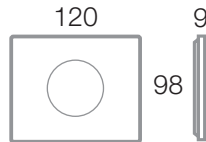

Per 1 presa di corrente  
For 1 socket outlet

<b>44PAQ90BAN</b> Bronzo anticato Antiqued bronze		1	1
<b>44PAQ90BRZ</b> Bronzo effetto spazzolato Brushed bronze effect		1	1
<b>44PAQ90ORO</b> Oro effetto spazzolato Gold brushed effect		1	1

Supporto da utilizzare  
To be used with



44A03

da completare con copriforo 442TC13R  
to be used with 442TC13R blank insert

Scatole utilizzabili  
Available boxes



Pareti in muratura  
Brickwork walls



Pareti in cartongesso  
Hollow walls

Descrizione Description

Info

€

□

□

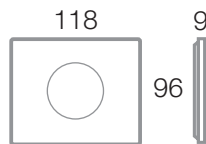

Per 1 presa di corrente  
For 1 socket outlet

<b>44PAN90ALS</b> Alluminio naturale spazzolato - fornita con n. 1 ghiera in plastica cromata Natural brushed aluminium - supplied with 1 ring plastic chrome		1	1
<b>44PAN90ANS</b> Alluminio antracite spazzolato - fornita con n. 1 ghiera in plastica cromata Anthracite brushed aluminium - supplied with 1 ring plastic chrome		1	1

Supporto da utilizzare  
To be used with



44A03

da completare con copriforo 442TC13R  
to be used with 442TC13R blank insert

Scatole utilizzabili  
Available boxes



Pareti in muratura  
Brickwork walls



Pareti in cartongesso  
Hollow walls



Per la disponibilità contattare la rete commerciale  
For availability please contact sales dept.



Disponibilità fino ad esaurimento scorte  
Available until stock out



Prodotto per scatola rettangolare inglese  
Product for British standard rectangular box



Prodotto per Export  
For Export only

Placche "New Style" in alluminio per scatola 3 moduli (interasse 83,5 mm)  
 "New Style" aluminium front plates for 3 modules box (fixing centres 83,5 mm)

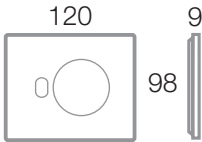
Descrizione Description		Info	€	<input type="checkbox"/>	<input type="checkbox"/>
 					
<b>Per 1 presa di corrente</b> For 1 socket outlet					
■ 44PANQ902BAN	Bronzo anticato Antiqued bronze		1	1	
■ 44PANQ902BRZ	Bronzo effetto spazzolato Brushed bronze effect		1	1	
■ 44PANQ902ORO	Oro effetto spazzolato Gold brushed effect		1	1	



Supporto da utilizzare  
To be used with



Scatole utilizzabili  
Available boxes



Pareti in muratura  
Brickwork walls



Pareti in cartongesso  
Hollow walls

Placche "Vera 44" per scatola tonda o quadrata  
 "Vera 44" front plates for round or square box

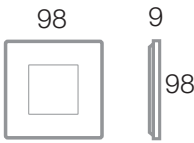
Descrizione Description		Info	€	<input type="checkbox"/>	<input type="checkbox"/>
 					
<b>Per 2 comandi standard 44</b> For 2 S44 standard controls					
■ 44PAQ22BAN	Bronzo anticato Antiqued bronze		1	1	
■ 44PAQ22BRZ	Bronzo effetto spazzolato Brushed bronze effect		1	1	
■ 44PAQ22ORO	Oro effetto spazzolato Gold brushed effect		1	1	

Nota: senza cornicetta di finitura  
 Note: without finishing frame

Supporto da utilizzare  
To be used with



Scatole utilizzabili  
Available boxes



Pareti in muratura  
Brickwork walls

Pareti in cartongesso  
Hollow walls



# Placche Alluminio

Aluminium front plates



Placche "Vera 44" per scatola tonda o quadrata  
"Vera 44" front plates for round or square box

194

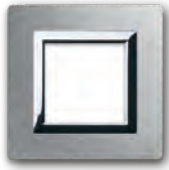

Cod. Code	Colore Colour	Cornicetta Inner frame	Info	€	□	□
-----------	---------------	------------------------	------	---	---	---

Per 2 comandi standard 44  
For 2 S44 standard controls

44PA22ALS	Alluminio naturale spazzolato Natural brushed aluminium	Cromo Chrome	1	1		
44PA22ANS	Alluminio antracite spazzolato Anthracite brushed aluminium	Cromo Chrome	1	1		

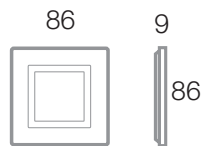

Cod. Code	Colore Colour	Cornicetta Inner frame	Info	€	□	□
-----------	---------------	------------------------	------	---	---	---

Per 4 comandi standard 44  
For 4 S44 standard controls

44PA24ALS	Alluminio naturale spazzolato Natural brushed aluminium	Cromo Chrome	1	1		
44PA24ANS	Alluminio antracite spazzolato Anthracite brushed aluminium	Cromo Chrome	1	1		

Supporto da utilizzare  
To be used with

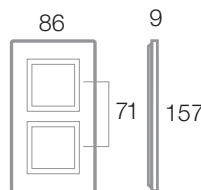

Scatole utilizzabili  
Available boxes



## Cornicette di ricambio Spare inner frames



Cod. Code	Colore Colour	Info	€	□	□
-----------	---------------	------	---	---	---

44CRV22B	Bianco Ral 9010 Ral 9010 white	2	50		
44CRV22N	Grigio scuro lucido Polished dark grey	2	50		
44CRV22CR	Cromo Chrome	2	50		



Per la disponibilità contattare la rete commerciale  
For availability please contact sales dept.



Disponibilità fino ad esaurimento scorte  
Available until stock out



Prodotto per scatola rettangolare inglese  
Product for British standard rectangular box



Prodotto per Export  
For Export only

Placche "Vera 44" per scatola tonda o quadrata  
"Vera 44" front plates for round or square box

195



Per 6 comandi standard 44  
For 6 S44 standard controls

Cod. Code	Colore Colour	Cornicetta Inner frame	Info	€	□	□
44PA26ALS	Alluminio naturale spazzolato Natural brushed aluminium	Cromo Chrome	1	1		
44PA26ANS	Alluminio antracite spazzolato Anthracite brushed aluminium	Cromo Chrome	1	1		

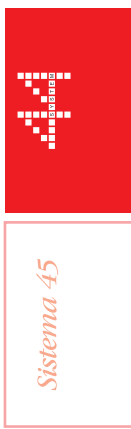
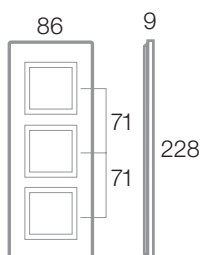

Per 8 comandi standard 44  
For 8 S44 standard controls

Cod. Code	Colore Colour	Cornicetta Inner frame	Info	€	□	□
44PA28ALS	Alluminio naturale spazzolato Natural brushed aluminium	Cromo Chrome	6	6		
44PA28ANS	Alluminio antracite spazzolato Anthracite brushed aluminium	Cromo Chrome	6	6		

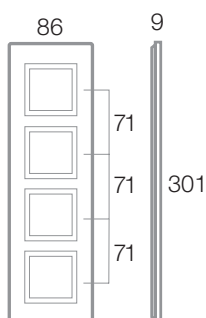

Supporto da utilizzare  
To be used with



44A02  
44A02SG  
44A02VT

Scatole utilizzabili  
Available boxes



Pareti in muratura  
Brickwork walls

Pareti in cartongesso  
Hollow walls

Cornicette di ricambio Spare inner frames



Cod. Code	Colore Colour	Info	€	□	□
44CRV22B	Bianco Ral 9010 Ral 9010 white	2	50		
44CRV22N	Grigio scuro lucido Polished dark grey	2	50		
44CRV22CR	Cromo Chrome	2	50		

Le dimensioni, salvo diversamente specificato, sono in mm  
Dimensions, except where otherwise specified, are in mm

□ Imballo Minimo pcs  
Min. Packaging pcs

□ Imballo Standard pcs  
Std. Packaging pcs



# Placche Alluminio

## Aluminium front plates



Placche "Vera 44" in alluminio per scatola 3 moduli (interasse 83,5 mm)  
"Vera 44" aluminium front plates for 3 modules box (fixing centres 83,5 mm)

196

Descrizione Description

Info

€

□

□

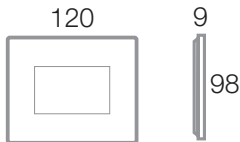

Supporto da utilizzare  
To be used with



44A03

Per 3 comandi standard 44  
For 3 S44 standard controls

■ 44PAQ3BAN

Bronzo anticato  
Antiqued bronze



1 1

■ 44PAQ3BRZ

Bronzo effetto spazzolato  
Brushed bronze effect



1 1

■ 44PAQ3ORO

Oro effetto spazzolato  
Gold brushed effect



1 1

Nota: senza cornicetta di finitura  
Note: without finishing frame

Scatole utilizzabili  
Available boxes



Pareti in muratura  
Brickwork walls



Pareti in cartongesso  
Hollow walls

Cod. Code

Colore Colour

Cornicetta Inner frame

Info

€

□

□



Supporto da utilizzare  
To be used with



44A03

Per 3 comandi standard 44  
For 3 S44 standard controls

44PA3ALS

Alluminio naturale spazzolato  
Natural brushed aluminium

Cromo  
Chrome

1 1

44PA3ANS

Alluminio antracite spazzolato  
Anthracite brushed aluminium

Cromo  
Chrome

1 1

Scatole utilizzabili  
Available boxes



Pareti in muratura  
Brickwork walls



Pareti in cartongesso  
Hollow walls

### Cornicette di ricambio Spare inner frames

Cod. Code

Colore Colour

Info

€

□

□



44CRV3B

Bianco Ral 9010  
Ral 9010 white

2 50

44CRV3N

Grigio scuro lucido  
Polished dark grey

2 50

44CRV3CR

Cromo  
Chrome

2 50



Per la disponibilità contattare la rete commerciale  
For availability please contact sales dept.



Disponibilità fino ad esaurimento scorte  
Available until stock out



Prodotto per scatola rettangolare inglese  
Product for British standard rectangular box



Prodotto per Export  
For Export only

Placche "Vera 44" in alluminio per scatola 4 moduli (interasse 108,5 mm)  
 "Vera 44" aluminium front plates for 4 modules box (fixing centres 108,5 mm)

Descrizione Description	Info	€	□	□	197
<b>Per 4 comandi standard 44</b> <i>For 4 S44 standard controls</i>					
 ■ <b>44PAQ4BAN</b> Bronzo anticato <i>Antiqued bronze</i>			1	1	
■ <b>44PAQ4BRZ</b> Bronzo effetto spazzolato <i>Brushed bronze effect</i>			1	1	
■ <b>44PAQ4ORO</b> Oro effetto spazzolato <i>Gold brushed effect</i>			1	1	
Nota: senza cornicetta di finitura <i>Note: without finishing frame</i>					

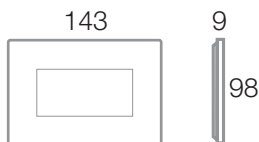

Supporto da utilizzare  
*To be used with*



Scatole utilizzabili  
*Available boxes*



Pareti in muratura *Brickwork walls*

Pareti in cartongesso *Hollow walls*

Cod. Code	Colore Colour	Cornicetta Inner frame	Info	€	□	□
<b>Per 4 comandi standard 44</b> <i>For 4 S44 standard controls</i>						
<b>44PA4ALS</b>	Alluminio naturale spazzolato <i>Natural brushed aluminium</i>	Cromo <i>Chrome</i>			1	1
<b>44PA4ANS</b>	Alluminio antracite spazzolato <i>Anthracite brushed aluminium</i>	Cromo <i>Chrome</i>			1	1



Supporto da utilizzare  
*To be used with*



Scatole utilizzabili  
*Available boxes*



Pareti in muratura *Brickwork walls*

Pareti in cartongesso *Hollow walls*

Cornicette di ricambio *Spare inner frames*

Cod. Code	Colore Colour	Info	€	□	□
<b>44CRV4B</b>	Bianco Ral 9010 <i>Ral 9010 white</i>			2	50
<b>44CRV4N</b>	Grigio scuro lucido <i>Polished dark grey</i>			2	50
<b>44CRV4CR</b>	Cromo <i>Chrome</i>			2	50



Le dimensioni, salvo diversamente specificato, sono in mm  
 Dimensions, except where otherwise specified, are in mm

Imballo Minimo pcs  
Min. Packaging pcs

Imballo Standard pcs  
Std. Packaging pcs



# Placche Alluminio

## Aluminium front plates

Placche "Vera 44" in alluminio per scatola 7 moduli (interasse 158,5 mm)  
 "Vera 44" aluminium front plates for 7 modules box (fixing centres 158,5 mm)

198



Descrizione Description

Info

€

□

□

Per 7 comandi standard 44  
 For 7 S44 standard controls

■ 44PAQ7BAN

Bronzo anticato  
 Antiqued bronze



1 1

■ 44PAQ7BRZ

Bronzo effetto spazzolato  
 Brushed bronze effect



1 1

■ 44PAQ7ORO

Oro effetto spazzolato  
 Gold brushed effect



1 1

Nota: senza cornicetta di finitura  
 Note: without finishing frame

Supporto da utilizzare  
 To be used with



44A07

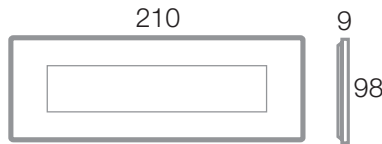

Cod. Code

Colore Colour

Cornicetta Inner frame

Info

€

□

□



Per 7 comandi standard 44  
 For 7 S44 standard controls

44PA7ALS

Alluminio naturale spazzolato  
 Natural brushed aluminium

Cromo  
 Chrome

1 1

44PA7ANS

Alluminio antracite spazzolato  
 Anthracite brushed aluminium

Cromo  
 Chrome

1 1

Supporto da utilizzare  
 To be used with



44A07

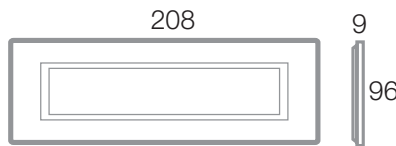

Scatole utilizzabili  
 Available boxes



2506

Pareti in muratura Brickwork walls

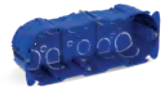

256CG

Pareti in cartongesso Hollow walls

### Cornicette di ricambio Spare inner frames

Cod. Code

Colore Colour

Info

€

□

□



44CRV7B

Bianco Ral 9010  
 Ral 9010 white

2 30

44CRV7N

Grigio scuro lucido  
 Polished dark grey

2 30

44CRV7CR

Cromo  
 Chrome

2 30



Per la disponibilità contattare  
 la rete commerciale  
 For availability please contact  
 sales dept.



Disponibilità fino ad  
 esaurimento scorte  
 Available until stock out



Prodotto per scatola  
 rettangolare inglese  
 Product for British standard  
 rectangular box



Prodotto  
 per Export  
 For Export  
 only

Placche "Vera 44" in alluminio per scatola BL02..  
 "Vera 44" aluminium front plates for BL02.. box

199



Per 6(3+3) comandi standard 44  
 For 6(3+3) S44 standard controls

Cod. Code	Colore Colour	Cornicetta Inner frame	Info	€	□	□
44PA33ALS	Alluminio naturale spazzolato Natural brushed aluminium	Cromo Chrome		1	1	
44PA33ANS	Alluminio antracite spazzolato Anthracite brushed aluminium	Cromo Chrome		1	1	

Supporto da utilizzare  
 To be used with



44A33

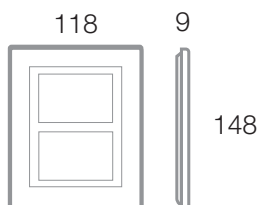

Scatola da utilizzare  
 To be used with



BL02P  
 Pareti in muratura  
 Brickwork walls



BL02CG  
 Pareti in cartongesso  
 Hollow walls

Cornicette di ricambio Spare inner frames



Cod. Code	Colore Colour	Info	€	□	□
44CRV33CR	Cromo Chrome		2	50	
44CRV33CR/AP	Cromo - versione senza traversino centrale da utilizzare con diffusori sonori 441AP01 o 442AP01 Chrome - version without central cross bar to be used with 441AP01 or 442AP01 loudspeakers		2	50	

Placche "Vera 44" in alluminio per scatola BL05..  
 "Vera 44" aluminium front plates for BL05.. box



Per 12(6+6) comandi standard 44  
 For 12(6+6) S44 standard controls

Cod. Code	Colore Colour	Cornicetta Inner frame	Info	€	□	□
44PA12ALS	Alluminio naturale spazzolato Natural brushed aluminium	Cromo Chrome		1	1	
44PA12ANS	Alluminio antracite spazzolato Anthracite brushed aluminium	Cromo Chrome		1	1	

Supporto da utilizzare  
 To be used with



44A12

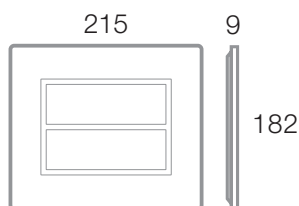

Scatola da utilizzare  
 To be used with



BL05P  
 Pareti in muratura  
 Brickwork walls

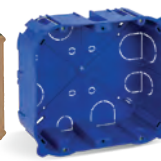

BL05CG  
 Pareti in cartongesso  
 Hollow walls

Le dimensioni, salvo diversamente specificato, sono in mm  
 Dimensions, except where otherwise specified, are in mm

□ Imballo Minimo pcs  
 Min. Packaging pcs

□ Imballo Standard pcs  
 Std. Packaging pcs



# Placche

## Front Plates

Design:  
B. Dall'Eco  
L. Merletti

200

### I colori delle placche "Ave Touch" VETRO

*"Ave Touch" GLASS front plate colours*



**44PVTC01BL**  
Bianco  
finitura lucida  
*Clear white*



**44PVTC01GO**  
Grigio argentato  
finitura opaca  
*Frosted silver grey*



**44PVTC01NAL**  
Nero assoluto  
finitura lucida  
*Clear absolute black*



**44PVTC01GOLD**  
Gold  
finitura lucida  
*Clear gold*

### I colori delle placche "Vera 44" VETRO

*"Vera 44" front plates colours for rectangular box*



**44PV3BL**  
Bianco  
finitura lucida  
*Clear white*



**44PV3GO**  
Grigio argentato  
finitura opaca  
*Frosted silver grey*



**44PV3NAL**  
Nero assoluto  
finitura lucida  
*Clear absolute black*



**44PV3GOLD**  
Gold  
finitura lucida  
*Clear gold*

### Ring di finitura *Finishing ring*

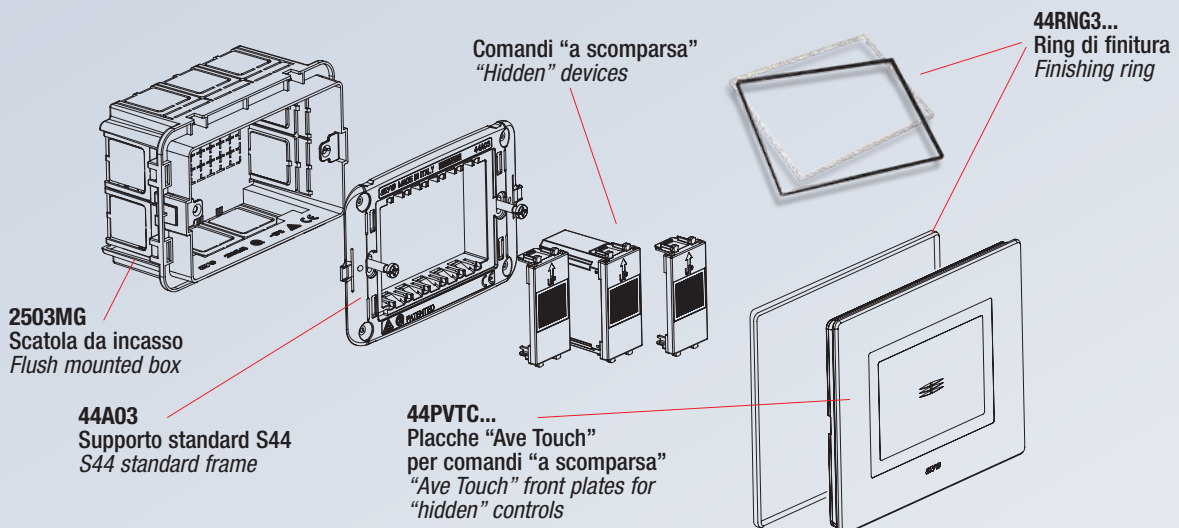

**I colori delle placche a levetta "NEW STYLE" VETRO**  
*"NEW STYLE" toggle front plates colours for rectangular box*



**44PVN01BL**  
Bianco  
finitura lucida  
*Clear white*



**44PVN01NAL**  
Nero assoluto  
finitura lucida  
*Clear absolute black*

**Soluzione con placche NEW STYLE vetro**  
*Solutions with glass NEW STYLE front plates*

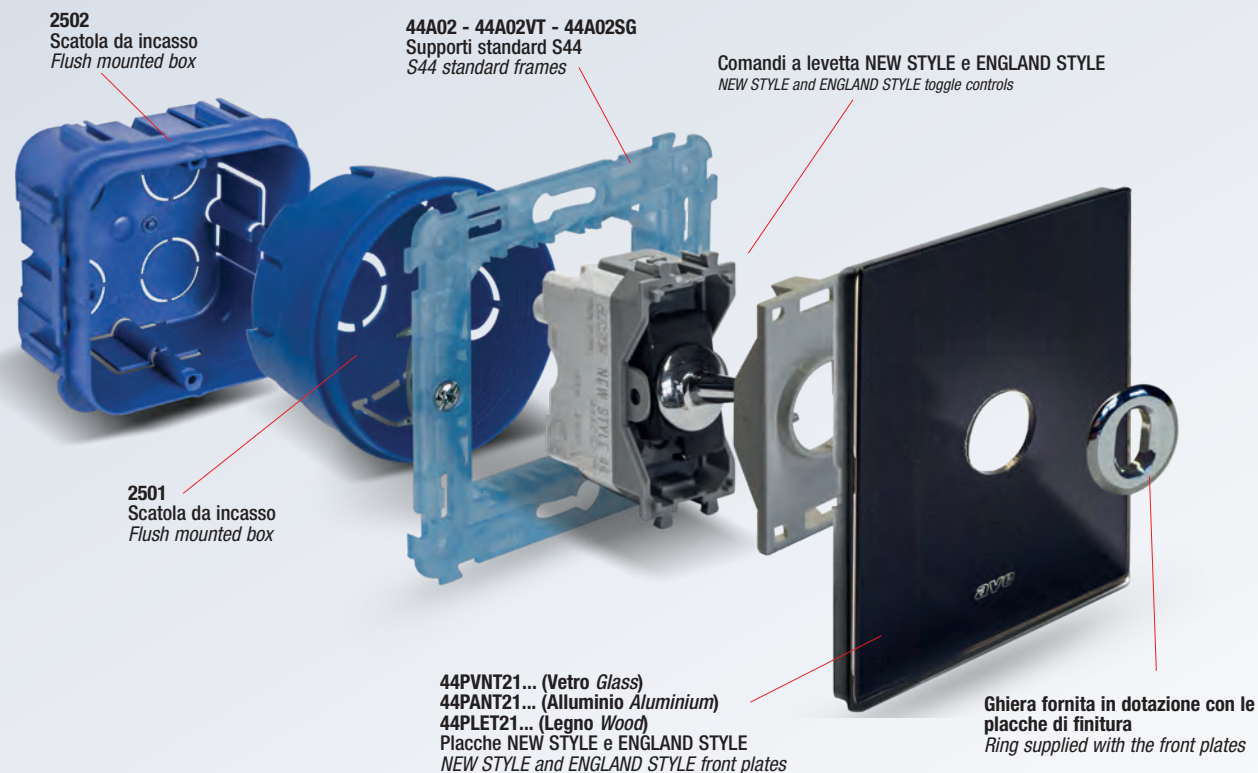



# Placche Vetro

## Glass front plates



Placche "Ave Touch" in vetro per scatola tonda o quadrata  
"Ave Touch" glass front plates for round or square box

202

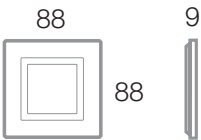

Descrizione Description

Info

€

□

□

Per 1 comando "a scomparsa"  
For 1 "hidden" control

□ 44PVTG21BL	1	1
Bianco finitura lucida Clear white		
■ 44PVTG21GO	1	1
Grigio argentato finitura opaca Frosted silver grey		
■ 44PVTG21GOLD	1	1
Oro finitura lucida Clear gold		
■ 44PVTG21NAL	1	1
Nero assoluto finitura lucida Clear absolute black		

**Nota:** assicurarsi che la placca sia perfettamente aderente agli apparecchi di comando "a scomparsa"

**Note:** make sure that the front plate sticks perfectly to the "hidden" control devices

Descrizione Description

Info

€

□

□

Per 2 comandi "a scomparsa"  
For 2 "hidden" controls

□ 44PVTG22BL	1	1
Bianco finitura lucida Clear white		
■ 44PVTG22GO	1	1
Grigio argentato finitura opaca Frosted silver grey		
■ 44PVTG22GOLD	1	1
Oro finitura lucida Clear gold		
■ 44PVTG22NAL	1	1
Nero assoluto finitura lucida Clear absolute black		

**Nota:** assicurarsi che la placca sia perfettamente aderente agli apparecchi di comando "a scomparsa"

**Note:** make sure that the front plate sticks perfectly to the "hidden" control devices

Supporto da utilizzare  
To be used with



44A02  
44A02SG  
44A02VT

Scatole utilizzabili  
Available boxes



2501

2501P

2502

251CG

Pareti in muratura  
Brickwork walls

Pareti in cartongesso  
Hollow walls



Per la disponibilità contattare la rete commerciale  
For availability please contact sales dept.



Disponibilità fino ad esaurimento scorte  
Available until stock out



Prodotto per scatola rettangolare inglese  
Product for British standard rectangular box



Prodotto per Export  
For Export only

Placche "Ave Touch" in vetro per scatola 3 moduli (interasse 83,5 mm)  
 "Ave Touch" glass front plates for rectangular 3 modules box (fixing centres 83,5 mm)

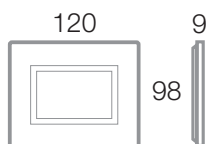

Descrizione Description

Info

€

□

□

Per 1 comando "a scomparsa"  
 For 1 "hidden" control

□ 44PVT01BL	1	1
Bianco finitura lucida Clear white		
■ 44PVT01GO	1	1
Grigio argentato finitura opaca Frosted silver grey		
■ 44PVT01GOLD	1	1
Oro finitura lucida Clear gold		
■ 44PVT01NAL	1	1
Nero assoluto finitura lucida Clear absolute black		

**Nota:** assicurarsi che la placca sia perfettamente aderente agli apparecchi di comando "a scomparsa"

**Note:** make sure that the front plate sticks perfectly to the "hidden" control devices

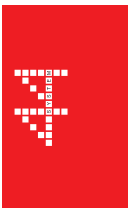

Sistema 45

Descrizione Description

Info

€

□

□

Per 2 comandi "a scomparsa"  
 For 2 "hidden" controls

□ 44PVT02BL	1	1
Bianco finitura lucida Clear white		
■ 44PVT02GO	1	1
Grigio argentato finitura opaca Frosted silver grey		
■ 44PVT02GOLD	1	1
Oro finitura lucida Clear gold		
■ 44PVT02NAL	1	1
Nero assoluto finitura lucida Clear absolute black		

**Nota:** assicurarsi che la placca sia perfettamente aderente agli apparecchi di comando "a scomparsa"

**Note:** make sure that the front plate sticks perfectly to the "hidden" control devices

Supporto da utilizzare  
 To be used with



44A03

Scatole utilizzabili  
 Available boxes



2503MG

253X4

SFM3/HP

Pareti in muratura Brickwork walls



253CGPR

253CG

253X4CG

SFM3CG/HP

Pareti in cartongesso Hollow walls



# Placche Vetro

## Glass front plates



Placche "Ave Touch" in vetro per scatola 3 moduli (interasse 83,5 mm)  
 "Ave Touch" glass front plates for rectangular 3 modules box (fixing centres 83,5 mm)

204

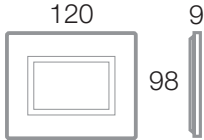

Descrizione Description

Info

€

□

□

Per 3 comandi "a scomparsa"  
 For 3 "hidden" controls

□ 44PVT3BL	1	1
Bianco finitura lucida Clear white		
■ 44PVT3GO	1	1
Grigio argentato finitura opaca Frosted silver grey		
■ 44PVT3GOLD	1	1
Oro finitura lucida Clear gold		
■ 44PVT3NAL	1	1
Nero assoluto finitura lucida Clear absolute black		

**Nota:** assicurarsi che la placca sia perfettamente aderente agli apparecchi di comando "a scomparsa"

**Note:** make sure that the front plate sticks perfectly to the "hidden" control devices

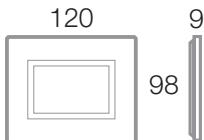

Descrizione Description

Info

€

□

□

Per 6 (3+3) comandi "a scomparsa"  
 For 6 (3+3) "hidden" controls

□ 44PVT16BL	1	1
Bianco finitura lucida Clear white		
■ 44PVT16GO	1	1
Grigio argentato finitura opaca Frosted silver grey		
■ 44PVT16GOLD	1	1
Oro finitura lucida Clear gold		
■ 44PVT16NAL	1	1
Nero assoluto finitura lucida Clear absolute black		

**Nota:** assicurarsi che la placca sia perfettamente aderente agli apparecchi di comando "a scomparsa"

**Note:** make sure that the front plate sticks perfectly to the "hidden" control devices

Supporto da utilizzare  
 To be used with



44A03

Scatole utilizzabili  
 Available boxes



2503MG

253X4

SFM3/HP

Pareti in muratura Brickwork walls

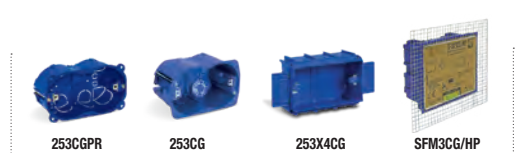

253CGPR

253CG

253X4CG

SFM3CG/HP

Pareti in cartongesso Hollow walls



Per la disponibilità contattare la rete commerciale  
 For availability please contact sales dept.



Disponibilità fino ad esaurimento scorte  
 Available until stock out



Prodotto per scatola rettangolare inglese  
 Product for British standard rectangular box



Prodotto per Export  
 For Export only

**Placche "Ave Touch" in vetro per scatola 4 moduli (interasse 108,5 mm)**  
**"Ave Touch" glass front plates for rectangular 4 modules box (fixing centres 108,5 mm)**

205

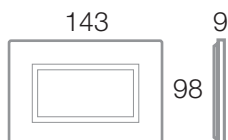

**Descrizione Description**

**Info**

€

□

□

**Per 3 comandi "a scomparsa"**  
**For 3 "hidden" controls**

□ 44PVT03BL	a commessa upon request	1	1
Bianco finitura lucida Clear white			
■ 44PVT03GO	a commessa upon request	1	1
Grigio argentato finitura opaca Frosted silver grey			
■ 44PVT03NAL	a commessa upon request	1	1
Nero assoluto finitura lucida Clear absolute black			

**Nota:** assicurarsi che la placca sia perfettamente aderente agli apparecchi di comando "a scomparsa"

**Note:** make sure that the front plate sticks perfectly to the "hidden" control devices



Sistema 45

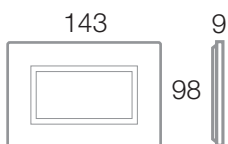

**Descrizione Description**

**Info**

€

□

□

**Per 4 comandi "a scomparsa"**  
**For 4 "hidden" controls**

□ 44PVT4BL		1	1
Bianco finitura lucida Clear white			
■ 44PVT4GO		1	1
Grigio argentato finitura opaca Frosted silver grey			
■ 44PVT4GOLD		1	1
Oro finitura lucida Clear gold			
■ 44PVT4NAL		1	1
Nero assoluto finitura lucida Clear absolute black			

**Nota:** assicurarsi che la placca sia perfettamente aderente agli apparecchi di comando "a scomparsa"

**Note:** make sure that the front plate sticks perfectly to the "hidden" control devices

**Supporto da utilizzare**  
**To be used with**



**Scatole utilizzabili**  
**Available boxes**



Pareti in muratura Brickwork walls



Pareti in cartongesso Hollow walls



# Placche Vetro

## Glass front plates

NEW WIRING ACCESSORIES

Placche "Ave Touch" in vetro per scatola 6-7 moduli (interasse 158,5 mm)  
 "Ave Touch" glass front plates for rectangular 6-7 modules box (fixing centres 158,5 mm)

206

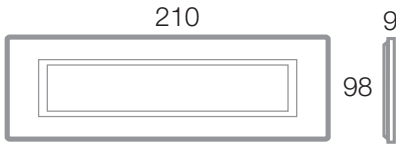

### Descrizione Description

Info

€

□

□

Per 4 comandi "a scomparsa"  
 For 4 "hidden" controls

□ 44PVT C04BL	a commessa upon request	1	1
Bianco finitura lucida Clear white			
■ 44PVT C04GO	a commessa upon request	1	1
Grigio argentato finitura opaca Frosted silver grey			
■ 44PVT C04NAL	a commessa upon request	1	1
Nero assoluto finitura lucida Clear absolute black			

**Nota:** assicurarsi che la placca sia perfettamente aderente agli apparecchi di comando "a scomparsa"

**Note:** make sure that the front plate sticks perfectly to the "hidden" control devices

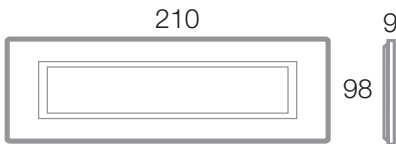

### Descrizione Description

Info

€

□

□

Per 7 comandi "a scomparsa"  
 For 7 "hidden" controls

□ 44PVT C7BL		1	1
Bianco finitura lucida Clear white			
■ 44PVT C7GO		1	1
Grigio argentato finitura opaca Frosted silver grey			
■ 44PVT C7GOLD		1	1
Oro finitura lucida Clear gold			
■ 44PVT C7NAL		1	1
Nero assoluto finitura lucida Clear absolute black			

**Nota:** assicurarsi che la placca sia perfettamente aderente agli apparecchi di comando "a scomparsa"

**Note:** make sure that the front plate sticks perfectly to the "hidden" control devices

### Supporto da utilizzare To be used with



44A07

### Scatole utilizzabili Available boxes



2506

Pareti in muratura Brickwork walls



256CG

Pareti in cartongesso Hollow walls



Per la disponibilità contattare la rete commerciale  
 For availability please contact sales dept.



Disponibilità fino ad esaurimento scorte  
 Available until stock out



Prodotto per scatola rettangolare inglese  
 Product for British standard rectangular box



Prodotto per Export  
 For Export only

Placche "Ave Touch" in vetro per scatola BL02P  
 "Ave Touch" glass front plates for BL02P box

Descrizione Description	Info	€	□	□	207
-------------------------	------	---	---	---	-----

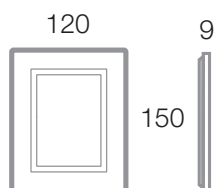

Per 6 (3+3) comandi "a scomparsa"  
 For 6 (3+3) "hidden" controls

□ 44PVT33BL Bianco finitura lucida Clear white	1	1			
■ 44PVT33GO Grigio argentato finitura opaca Frosted silver grey	1	1			
■ 44PVT33NAL Nero assoluto finitura lucida Clear absolute black	1	1			

**Nota:** assicurarsi che la placca sia perfettamente aderente agli apparecchi di comando "a scomparsa"

**Note:** make sure that the front plate sticks perfectly to the "hidden" control devices

Supporto da utilizzare  
 To be used with



44A33

Scatole utilizzabili  
 Available boxes



Pareti in muratura Brickwork walls



Pareti in cartongesso Hollow walls







# Placche Vetro

## Glass front plates



Placche "Ave Touch" in vetro per scatola 3 moduli (interasse 83,5 mm)  
 "Ave Touch" glass front plates for rectangular 3 modules box (fixing centres 83,5 mm)

208



Supporto da utilizzare  
To be used with



44A03

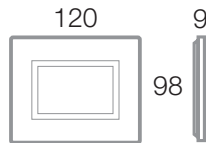

Descrizione Description

Info

€

□

□

Per 1 modulo pulsante "a scomparsa" con targhetta portanome  
For 1 "hidden" push-button module with name tag

□ 44PVTC88BL	1	1
Bianco finitura lucida Clear white		
■ 44PVTC88GO	1	1
Grigio argentato finitura opaca Frosted silver grey		
■ 44PVTC88NAL	1	1
Nero assoluto finitura lucida Clear absolute black		

**Nota:** assicurarsi che la placca sia perfettamente aderente agli apparecchi di comando "a scomparsa"

**Note:** make sure that the front plate sticks perfectly to the "hidden" control devices



Supporto da utilizzare  
To be used with



44A03

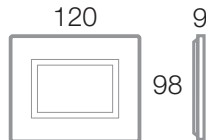

Descrizione Description

Info

€

□

□

Per 1 modulo segnalazione luminosa/illuminazione "a scomparsa"  
For 1 "hidden" light/lighting signal module

□ 44PVTC76BL	1	1
Bianco finitura lucida Clear white		
■ 44PVTC76NAL	1	1
Nero assoluto finitura lucida Clear absolute black		



Per la disponibilità contattare la rete commerciale  
For availability please contact sales dept.



Disponibilità fino ad esaurimento scorte  
Available until stock out



Prodotto per scatola rettangolare inglese  
Product for British standard rectangular box



Prodotto per Export  
For Export only

**Placche "Ave Touch" in vetro a scivolo per scatola 3 moduli (interasse 83,5 mm)**  
**"Ave Touch" sliding glass front plates for rectangular 3 modules box (fixing centres 83,5 mm)**

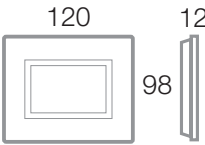
Descrizione Description	Info	€	□	□
  <b>□ 44PVTC3BL</b> A scivolamento per copertura 3 mod. S44 - simbolo "spina" Bianco finitura lucida <i>Sliding for covering 3 mod. S44 - "plug" symbol - Clear white</i>	1	1		
 <b>■ 44PVTC3GO</b> A scivolamento per copertura 3 mod. S44 - simbolo "spina" Grigio argentato finitura opaca <i>Sliding for covering 3 mod. S44 - "plug" symbol - Frosted silver grey</i>	1	1		
 <b>■ 44PVTC3GOLD</b> A scivolamento per copertura 3 mod. S44 - simbolo "spina" Oro finitura lucida <i>Sliding for covering 3 mod. S44 - "plug" symbol - Clear gold</i>	1	1		
 <b>■ 44PVTC3NAL</b> A scivolamento per copertura 3 mod. S44 - simbolo "spina" Nero assoluto finitura lucida <i>Sliding for covering 3 mod. S44 - "plug" symbol - Clear absolute black</i>	1	1		
<b>Note:</b> ✓ Da utilizzare solo con supporti speciali 44ATC03... ✓ Simbolo spina illuminabile con inserto a led fornito in dotazione con il supporto. ✓ Utilizzabile con tutti i prodotti 1, 2 o 3 moduli standard Sistema 44 ad esclusione dei codici a pag. 185. <b>Note:</b> ✓ To be used only with special frame 44ATC03... ✓ "plug" symbol lightable by led supplied with the frame. ✓ It can be used with all the system 44 standard products 1-2 or 3 modules except for the codes on page 185.				

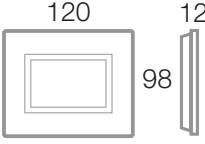

Descrizione Description	Info	€	□	□
  <b>□ 44PVTCN3BL</b> A scivolamento per copertura 3 mod. S44 Bianco finitura lucida <i>Sliding for covering 3 mod. S44 - Clear white</i>	1	1		
 <b>■ 44PVTCN3GO</b> A scivolamento per copertura 3 mod. S44 Grigio argentato finitura opaca <i>Sliding for covering 3 mod. S44 - Frosted silver grey</i>	1	1		
 <b>■ 44PVTCN3NAL</b> A scivolamento per copertura 3 mod. S44 Nero assoluto finitura lucida <i>Sliding for covering 3 mod. S44 - Clear absolute black</i>	1	1		
<b>Note:</b> ✓ Da utilizzare solo con supporti speciali 44ATC03... ✓ Simbolo spina illuminabile con inserto a led fornito in dotazione con il supporto. ✓ Utilizzabile con tutti i prodotti 1, 2 o 3 moduli standard Sistema 44 ad esclusione dei codici a pag. 185. <b>Note:</b> ✓ To be used only with special frame 44ATC03... ✓ "plug" symbol lightable by led supplied with the frame. ✓ It can be used with all the system 44 standard products 1-2 or 3 modules except for the codes on page 185.				

**Supporto da utilizzare**  
**To be used with**



**Scatole utilizzabili**  
**Available boxes**



Pareti in muratura Brickwork walls

Pareti in cartongesso Hollow walls

Le dimensioni, salvo diversamente specificato, sono in mm  
 Dimensions, except where otherwise specified, are in mm

□ Imballo Minimo pcs  
 Min. Packaging pcs

□ Imballo Standard pcs  
 Std. Packaging pcs



# Placche Vetro

## Glass front plates

Placche "New Style 44" in vetro per scatola tonda e quadrata  
 "New Style 44" glass front plates for round and square box



BREVETTO AVE N° 247-208-233  
 MODELLO COMUNITARIO  
 AVE PATENT N° 247-208-233

210

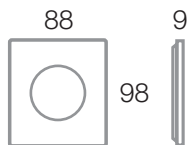
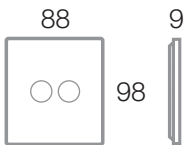
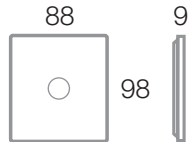

Supporto da utilizzare  
 To be used with



44A02  
 44A02SG  
 44A02VT

### Descrizione Description

Info

€

□

□

Per 1 comando a levetta  
 For 1 toggle control

□ 44PVNT21BL	1	1
Bianco finitura lucida Clear white		
■ 44PVNT21NAL	1	1
Nero assoluto finitura lucida Clear absolute black		

### Descrizione Description

Info

€

□

□

Per 2 comandi a levetta  
 For 2 toggle controls

□ 44PVNT22BL	1	1
Bianco finitura lucida Clear white		
■ 44PVNT22NAL	1	1
Nero assoluto finitura lucida Clear absolute black		

### Descrizione Description

Info

€

□

□

Per 1 presa di corrente  
 For 1 socket outlet

□ 44PVNT90BL	1	1
Bianco finitura lucida - fornita con n. 1 ghiera in plastica cromata Clear white - shuttered - supplied with 1 ring plastic chrome		
■ 44PVNT90NAL	1	1
Nero assoluto finitura lucida - fornita con n. 1 ghiera in plastica cromata Clear absolute black - shuttered - supplied with 1 ring plastic chrome		

Scatole utilizzabili  
 Available boxes



2501



2501P



2502



251CG

Pareti in muratura  
 Brickwork walls

Pareti in cartongesso  
 Hollow walls



Per la disponibilità contattare  
 la rete commerciale  
 For availability please contact  
 sales dept.



Disponibilità fino ad  
 esaurimento scorte  
 Available until stock out



Prodotto per scatola  
 rettangolare inglese  
 Product for British standard  
 rectangular box



Prodotto  
 per Export  
 For Export  
 only

Placche "New Style 44" in vetro per scatola 3 moduli (interasse 83,5 mm)  
 "New Style 44" glass front plates for 3 modules box (fixing centre 83,5 mm)

BREVETTO AVE N° 247-208-233  
 MODELLO COMUNITARIO  
 AVE PATENT N° 247-208-233

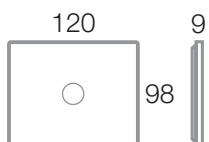

Descrizione Description

Info € □ □

Per 1 comando a levetta  
 For 1 toggle control

□ 44PVN01BL	1	1
Bianco finitura lucida Clear white		
■ 44PVN01NAL	1	1
Nero assoluto finitura lucida Clear absolute black		



Sistema 45

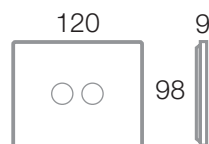

Descrizione Description

Info € □ □

Per 2 comandi a levetta  
 For 2 toggle controls

□ 44PVN02BL	1	1
Bianco finitura lucida Clear white		
■ 44PVN02NAL	1	1
Nero assoluto finitura lucida Clear white		

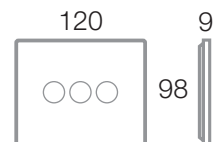

Descrizione Description

Info € □ □

Per 3 comandi a levetta  
 For 3 toggle controls

□ 44PVN03BL	1	1
Bianco finitura lucida Clear white		
■ 44PVN03NAL	1	1
Nero assoluto finitura lucida Clear absolute black		

Supporto da utilizzare  
 To be used with



Scatole utilizzabili  
 Available boxes



Pareti in muratura  
 Brickwork walls



Pareti in cartongesso  
 Hollow walls



# Placche Vetro

## Glass front plates

Placche "New Style 44" in vetro per scatola 4 moduli (interasse 108,5 mm)  
 "New Style 44" glass front plates for 4 modules box (fixing centre 108,5 mm)

212

Descrizione Description

Info

€

□

□



Per 4 comandi a levetta  
 For 4 toggle controls

□ 44PVN04BL	1	1
Bianco finitura lucida Clear white		
■ 44PVN04NAL	1	1
Nero assoluto finitura lucida Clear absolute black		

Supporto da utilizzare  
 To be used with

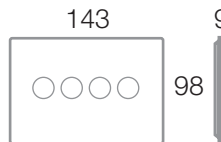

Scatole utilizzabili  
 Available boxes

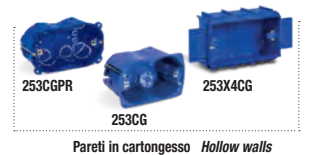

Placche "New Style 44" in vetro per scatola 3 moduli (interasse 83,5 mm)  
 "New Style 44" glass front plates for 3 modules box (fixing centre 83,5 mm)

Descrizione Description

Info

€

□

□



Per 1 presa di corrente  
 For 1 socket outlet

□ 44PVN90BL	1	1
Bianco finitura lucida - fornita con n. 1 ghiera in plastica cromata Clear white - shuttered - supplied with 1 ring plastic chrome		
■ 44PVN90NAL	1	1
Nero assoluto finitura lucida - fornita con n. 1 ghiera in plastica cromata Clear absolute black - shuttered - supplied with 1 ring plastic chrome		

Supporto da utilizzare  
 To be used with

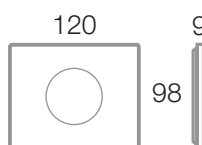

Scatole utilizzabili  
 Available boxes

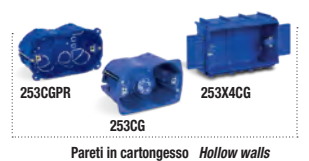

Per la disponibilità contattare la rete commerciale  
 For availability please contact sales dept.



Disponibilità fino ad esaurimento scorte  
 Available until stock out



Prodotto per scatola rettangolare inglese  
 Product for British standard rectangular box



Prodotto per Export  
 For Export only

Placche "Vera 44" in vetro per scatola tonda o quadrata  
 "Vera 44" glass front plates for round or square box

213



Cod. Code	Colore Colour	Cornicetta Inner frame	Info	€	□	□
<b>Per 1 comando standard 44</b> <i>For 1 S44 standard control</i>						
44PV21BL	Bianco finitura lucida <i>Clear white</i>	Bianco Ral 9010 <i>Ral 9010 white</i>		1	1	

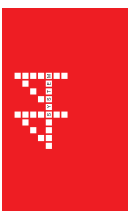

Sistema 45



Cod. Code	Colore Colour	Cornicetta Inner frame	Info	€	□	□
<b>Per 2 comandi standard 44</b> <i>For 2 S44 standard controls</i>						
44PV22BL	Bianco finitura lucida <i>Clear white</i>	Bianco Ral 9010 <i>Ral 9010 white</i>		1	1	
44PV22G0	Grigio argentato finitura opaca <i>Frosted silver grey</i>	Grigio scuro lucido <i>Polished dark grey</i>		1	1	
44PV22G0LD	Oro finitura lucida <i>Clear gold</i>	Grigio scuro lucido <i>Polished dark grey</i>		1	1	
44PV22NAL	Nero assoluto finitura lucida <i>Clear absolute black</i>	Cromo <i>Chrome</i>		1	1	

Supporto da utilizzare  
 To be used with



44A02  
 44A02SG  
 44A02VT

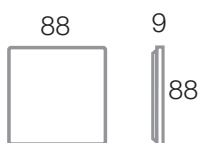

Scatole utilizzabili  
 Available boxes



Pareti in muratura  
 Brickwork walls

Pareti in cartongesso  
 Hollow walls

Cornicette di ricambio *Spare inner frames*



Cod. Code	Colore Colour	Info	€	□	□
<b>Per placche 2 comandi standard 44</b> <i>For 2 S44 standard controls front plates</i>					
44CRV22B	Bianco Ral 9010 <i>Ral 9010 white</i>		2	50	
44CRV22N	Grigio scuro lucido <i>Polished dark grey</i>		2	50	
44CRV22CR	Cromo <i>Chrome</i>		2	50	

Le dimensioni, salvo diversamente specificato, sono in mm  
 Dimensions, except where otherwise specified, are in mm

□ Imballo Minimo pcs  
 Min. Packaging pcs

□ Imballo Standard pcs  
 Std. Packaging pcs



# Placche Vetro

## Glass front plates



Placche "Vera 44" in vetro per scatola tonda o quadrata  
"Vera 44" glass front plates for round or square box

214



Cod. Code	Colore Colour	Cornicetta Inner frame	Info	€	□	□
<b>Per 4(2+2) comandi standard 44</b> <i>For 4(2+2) S44 standard controls</i>						
44PV24BL	Bianco finitura lucida <i>Clear white</i>	Bianco Ral 9010 <i>Ral 9010 white</i>		1	1	
44PV24GO	Grigio argentato finitura opaca <i>Frosted silver grey</i>	Grigio scuro lucido <i>Polished dark grey</i>		1	1	
44PV24GOLD	Oro finitura lucida <i>Clear gold</i>	Grigio scuro lucido <i>Polished dark grey</i>		1	1	
44PV24NAL	Nero assoluto finitura lucida <i>Clear absolute black</i>	Cromo <i>Chrome</i>		1	1	

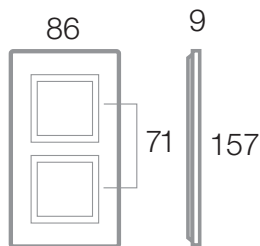

Cod. Code	Colore Colour	Cornicetta Inner frame	Info	€	□	□
<b>Per 6(2+2+2) comandi standard 44</b> <i>For 6(2+2+2) S44 standard controls</i>						
44PV26BL	Bianco finitura lucida <i>Clear white</i>	Bianco Ral 9010 <i>Ral 9010 white</i>		1	1	
44PV26GO	Grigio argentato finitura opaca <i>Frosted silver grey</i>	Grigio scuro lucido <i>Polished dark grey</i>		1	1	
44PV26GOLD	Oro finitura lucida <i>Clear gold</i>	Grigio scuro lucido <i>Polished dark grey</i>		1	1	
44PV26NAL	Nero assoluto finitura lucida <i>Clear absolute black</i>	Cromo <i>Chrome</i>		1	1	

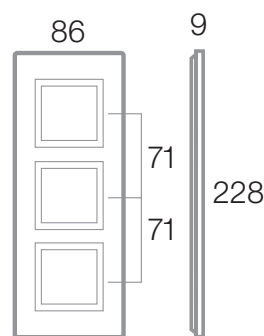

Supporto da utilizzare  
*To be used with*



Scatole utilizzabili  
*Available boxes*



### Cornicette di ricambio *Spare inner frames*

Cod. Code	Colore Colour	Info	€	□	□
44CRV22B	Bianco Ral 9010 <i>Ral 9010 white</i>		2	50	
44CRV22N	Grigio scuro lucido <i>Polished dark grey</i>		2	50	
44CRV22CR	Cromo <i>Chrome</i>		2	50	



Per la disponibilità contattare la rete commerciale  
For availability please contact sales dept.

Disponibilità fino ad esaurimento scorte  
Available until stock out

# Prodotto per scatola rettangolare inglese  
Product for British standard rectangular box

△ Prodotto per Export  
For Export only

Placche "Vera 44" in vetro per scatola tonda o quadrata  
 "Vera 44" glass front plates for round or square box



Cod. Code	Colore Colour	Cornicetta Inner frame	Info	€	□	□
<b>Per 8(2+2+2+2) comandi standard 44</b> <i>For 8(2+2+2+2) S44 standard controls</i>						
44PV28BL	Bianco finitura lucida <i>Clear white</i>	Bianco Ral 9010 <i>Ral 9010 white</i>		6	6	
44PV28GO	Grigio argentato finitura opaca <i>Frosted silver grey</i>	Grigio scuro lucido <i>Polished dark grey</i>		6	6	
44PV28GOLD	Oro finitura lucida <i>Clear gold</i>	Grigio scuro lucido <i>Polished dark grey</i>		6	6	
44PV28NAL	Nero assoluto finitura lucida <i>Clear absolute black</i>	Cromo <i>Chrome</i>		6	6	

215

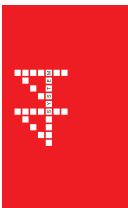

Sistema 45

Supporto da utilizzare  
 To be used with



44A02  
 44A02SG  
 44A02VT

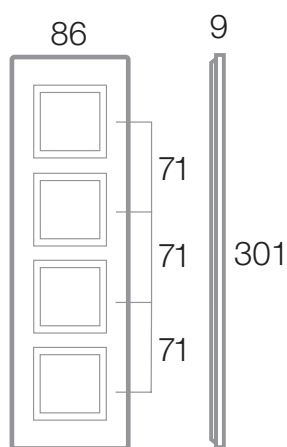

Scatole utilizzabili  
 Available boxes



Pareti in muratura  
 Brickwork walls

Pareti in cartongesso  
 Hollow walls

Cornicette di ricambio *Spare inner frames*



Cod. Code	Colore Colour	Info	€	□	□
44CRV22B	Bianco Ral 9010 <i>Ral 9010 white</i>		2	50	
44CRV22N	Grigio scuro lucido <i>Polished dark grey</i>		2	50	
44CRV22CR	Cromo <i>Chrome</i>		2	50	

Le dimensioni, salvo diversamente specificato, sono in mm  
 Dimensions, except where otherwise specified, are in mm

□ Imballo Minimo pcs  
 Min. Packaging pcs

□ Imballo Standard pcs  
 Std. Packaging pcs





# Placche Vetro

## Glass front plates



Placche "Vera 44" in vetro per scatola 3 moduli (interasse 83,5 mm)  
 "Vera 44" glass front plates for 3 modules box (fixing centres 83,5 mm)

216



Cod. Code	Colore Colour	Cornicetta Inner frame	Info	€	□	□
<b>Per 3 comandi standard 44</b> <i>For 3 S44 standard controls</i>						
44PV3BL	Bianco finitura lucida <i>Clear white</i>	Bianco Ral 9010 <i>Ral 9010 white</i>		1	1	
44PV3GO	Grigio argentato finitura opaca <i>Frosted silver grey</i>	Grigio scuro lucido <i>Polished dark grey</i>		1	1	
44PV3GOLD	Oro finitura lucida <i>Clear gold</i>	Grigio scuro lucido <i>Polished dark grey</i>		1	1	
44PV3NAL	Nero assoluto finitura lucida <i>Clear absolute black</i>	Cromo <i>Chrome</i>		1	1	

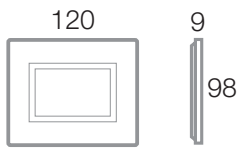

Supporto da utilizzare  
*To be used with*



Scatole utilizzabili  
*Available boxes*

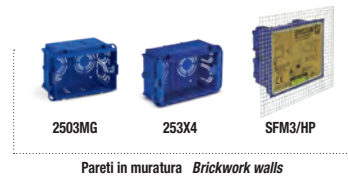

### Cornicette di ricambio *Spare inner frames*

Cod. Code	Colore Colour	Info	€	□	□
44CRV3B	Bianco Ral 9010 <i>Ral 9010 white</i>		2	50	
44CRV3N	Grigio scuro lucido <i>Polished dark grey</i>		2	50	
44CRV3CR	Cromo <i>Chrome</i>		2	50	



Per la disponibilità contattare la rete commerciale  
 For availability please contact sales dept.



Disponibilità fino ad esaurimento scorte  
 Available until stock out



Prodotto per scatola rettangolare inglese  
 Product for British standard rectangular box



Prodotto per Export  
 For Export only

Placche "Vera 44" in vetro per scatola 4 moduli (interasse 108,5 mm)  
 "Vera 44" glass front plates for 4 modules box (fixing centres 108,5 mm)

217



Cod. Code	Colore Colour	Cornicetta Inner frame	Info	€	□	□
<b>Per 4 comandi standard 44</b> <i>For 4 S44 standard controls</i>						
44PV4BL	Bianco finitura lucida <i>Clear white</i>	Bianco Ral 9010 <i>Ral 9010 white</i>		1	1	
44PV4GO	Grigio argentato finitura opaca <i>Frosted silver grey</i>	Grigio scuro lucido <i>Polished dark grey</i>		1	1	
44PV4GOLD	Oro finitura lucida <i>Clear gold</i>	Grigio scuro lucido <i>Polished dark grey</i>		1	1	
44PV4NAL	Nero assoluto finitura lucida <i>Clear absolute black</i>	Cromo <i>Chrome</i>		1	1	

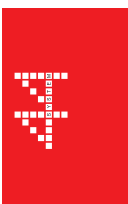

Sistema 45



Supporto da utilizzare  
 To be used with



Scatole utilizzabili  
 Available boxes



Cornicette di ricambio *Spare inner frames*



Cod. Code	Colore Colour	Info	€	□	□
44CRV4B	Bianco Ral 9010 <i>Ral 9010 white</i>			2	50
44CRV4N	Grigio scuro lucido <i>Polished dark grey</i>			2	50
44CRV4CR	Cromo <i>Chrome</i>			2	50



# Placche Vetro

## Glass front plates



Placche "Vera 44" in vetro per scatola 7 moduli (interasse 158,5 mm)  
 "Vera 44" glass front plates for 7 modules box (fixing centres 158,5 mm)

218



Cod. Code	Colore Colour	Cornicetta Inner frame	Info	€	□	□
<b>Per 7 comandi standard 44</b> <i>For 7 S44 standard controls</i>						
44PV7BL	Bianco finitura lucida <i>Clear white</i>	Bianco Ral 9010 <i>Ral 9010 white</i>	1	1		
44PV7GO	Grigio argentato finitura opaca <i>Frosted silver grey</i>	Grigio scuro lucido <i>Polished dark grey</i>	1	1		
44PV7GOLD	Oro finitura lucida <i>Clear gold</i>	Grigio scuro lucido <i>Polished dark grey</i>	1	1		
44PV7NAL	Nero assoluto finitura lucida <i>Clear absolute black</i>	Cromo <i>Chrome</i>	1	1		

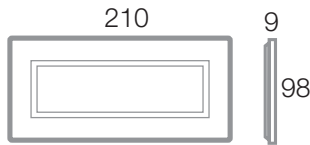

Supporto da utilizzare  
*To be used with*



Scatole utilizzabili  
*Available boxes*



Pareti in muratura *Brickwork walls*



Pareti in cartongesso *Hollow walls*

### Cornicette di ricambio *Spare inner frames*



Cod. Code	Colore Colour	Info	€	□	□
44CRV7B	Bianco Ral 9010 <i>Ral 9010 white</i>	2	30		
44CRV7N	Grigio scuro lucido <i>Polished dark grey</i>	2	30		
44CRV7CR	Cromo <i>Chrome</i>	2	30		



Per la disponibilità contattare  
 la rete commerciale  
 For availability please contact  
 sales dept.



Disponibilità fino ad  
 esaurimento scorte  
 Available until stock out



Prodotto per scatola  
 rettangolare inglese  
 Product for British standard  
 rectangular box



Prodotto  
 per Export  
 For Export  
 only

Placche "Vera 44" in vetro per scatola BL02..  
 "Vera 44" glass front plates for BL02.. box

219

Cod. Code	Colore Colour	Cornicetta Inner frame	Info	€	<input type="checkbox"/>	<input type="checkbox"/>
Per 6(3+3) comandi standard 44 For 6(3+3) S44 standard controls						
44PV33BL	Bianco finitura lucida Clear white	Bianco Ral 9010 Ral 9010 white		1	1	
44PV33NAL	Nero assoluto finitura lucida Clear absolute black	Cromo Chrome		1	1	



Supporto da utilizzare  
To be used with



44A33

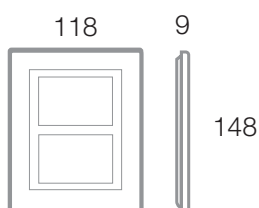

Scatola da utilizzare  
To be used with



BL02P  
Pareti in muratura  
Brickwork walls



BL02CG  
Pareti in cartongesso  
Hollow walls



Cornicette di ricambio Spare inner frames

Cod. Code	Colore Colour	Info	€	<input type="checkbox"/>	<input type="checkbox"/>
44CRV33CR	Cromo Chrome		2	50	
44CRV33CR/AP	Cromo - versione senza traversino centrale da utilizzare con diffusori sonori 441AP01 o 442AP01 Chrome - version without central cross bar to be used with 441AP01 or 442AP01 loudspeakers		2	50	



Placche "Vera 44" in vetro scatola BL05..  
 "Vera 44" glass front plates for BL05.. box

Cod. Code	Colore Colour	Info	€	<input type="checkbox"/>	<input type="checkbox"/>
Per 12(6+6) comandi standard 44 For 12(6+6) S44 standard controls					
44PV12BL	Bianco finitura lucida Clear white	Bianco Ral 9010 Ral 9010 white		1	1
44PV12NAL	Nero assoluto finitura lucida Clear absolute black	Cromo Chrome		1	1



Supporto da utilizzare  
To be used with



44A12

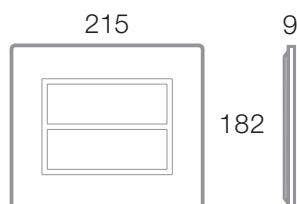

Scatola da utilizzare  
To be used with



BL05P  
Pareti in muratura  
Brickwork walls

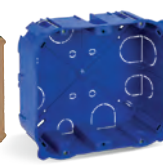

BL05CG  
Pareti in cartongesso  
Hollow walls

Le dimensioni, salvo diversamente specificato, sono in mm  
Dimensions, except where otherwise specified, are in mm

Imballo Minimo pcs  
Min. Packaging pcs

Imballo Standard pcs  
Std. Packaging pcs

# Placche

## Front Plates

Design:  
B. Dall'Eco  
L. Merletti

220

I colori delle placche VERA 44 LEGNO  
*VERA 44 Wood front plates colours*



**44PL3RS**  
Rovere sbiancato  
*Whitened oak*



**44PL22RS**  
Rovere sbiancato  
*Whitened oak*



I colori delle placche "ENGLAND STYLE" LEGNO  
"ENGLAND STYLE" WOOD front plates colours



**44PLE01NOC**  
Colore noce  
Walnut color



**44PLE3NOC**  
Colore noce  
Walnut color

Soluzione per scatola tonda con placche NEW STYLE Vetro / Alluminio e placche ENGLAND STYLE legno  
Solution for round box with glass/aluminium NEW STYLE front plates and wood ENGLAND STYLE front plates

**2502**  
Scatola da incasso  
Flush mounted box

**44A02 - 44A02VT - 44A02SG**  
Supporti standard S44  
S44 standard frames

Comandi a levetta NEW STYLE e ENGLAND STYLE  
NEW STYLE and ENGLAND STYLE toggle controls

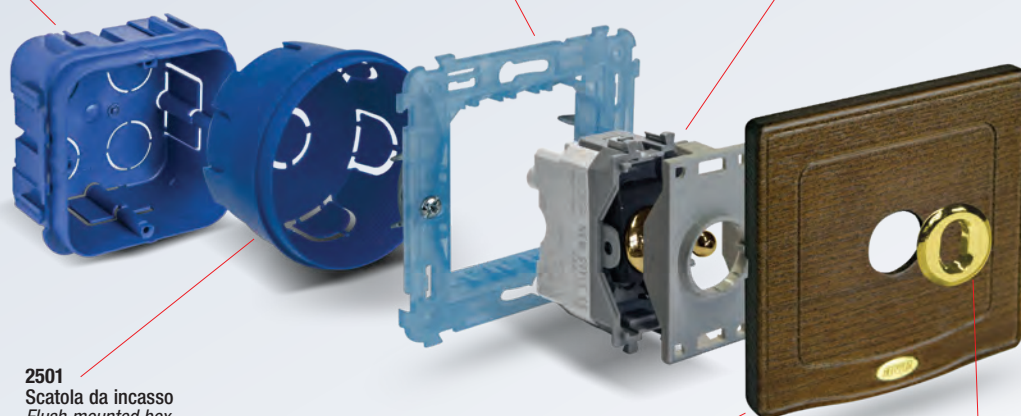

**2501**  
Scatola da incasso  
Flush mounted box

**44PVNT21...** (Vetro Glass)  
**44PANT21...** (Alluminio Aluminium)  
**44PLET21...** (Legno Wood)  
Placche NEW STYLE e ENGLAND STYLE  
NEW STYLE and ENGLAND STYLE front plates

Ghiera fornita in dotazione con le  
placche di finiture  
Ring supplied with the front plates



# Placche Legno

Wood front plates



Placche "England Style 44" in legno per scatola 3 moduli (interasse 83,5 mm)  
"England Style 44" wood front plates for 3 modules box (fixing centre 83,5 mm)

BREVETTO AVE n° 247-208  
MODELLO COMUNITARIO  
AVE PATENT n° 247-208-233

222



Descrizione Description

Info

€

□

□

Per 1 comando a levetta  
For 1 toggle control

■ 44PLE01NOC

Colore noce

Walnut

1 1



Descrizione Description

Info

€

□

□

Per 2 comandi a levetta  
For 2 toggle controls

■ 44PLE02NOC

Colore noce

Walnut

1 1



Descrizione Description

Info

€

□

□

Per 3 comandi a levetta  
For 3 toggle controls

■ 44PLE03NOC

Colore noce

Walnut

1 1

Supporto da utilizzare  
To be used with



44A03

124

9



88

Scatole utilizzabili  
Available boxes



2503MG

253X4

Pareti in muratura  
Brickwork walls



253CGPR

253CG

253X4CG

Pareti in cartongesso  
Hollow walls



Per la disponibilità contattare  
la rete commerciale  
For availability please contact  
sales dept.



Disponibilità fino ad  
esaurimento scorte  
Available until stock out



Prodotto per scatola  
rettangolare inglese  
Product for British standard  
rectangular box



Prodotto  
per Export  
For Export  
only

Placche "England Style 44" in legno per scatola 4 moduli (interasse 108,5 mm)  
 "England Style 44" wood front plates for 4 modules box (fixing centre 108,5 mm)

BREVETTO AVE N° 247-208  
 MODELLO COMUNITARIO  
 AVE PATENT N° 247-208-233

223



Descrizione Description

Info

€

□

□

Per 4 comandi a levetta  
 For 4 toggle controls

■ 44PLE04NOC	1	1
Colore noce Walnut		

Supporto da utilizzare  
 To be used with

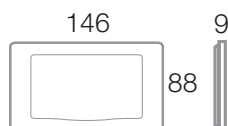

Scatole utilizzabili  
 Available boxes



Pareti in muratura Brickwork walls

Pareti in cartongesso Hollow walls

Placche "England Style 44" in legno per scatola 3 moduli (interasse 83,5 mm)  
 "England Style 44" wood front plates for 3 modules box (fixing centre 83,5 mm)

Descrizione Description

Info

€

□

□



Per 1 presa di corrente  
 For 1 socket outlet

■ 44PLE90NOC	1	1
Colore noce - fornita con ghiera in ottone Walnut - shuttered - supplied with brass ring		

Supporto da utilizzare  
 To be used with

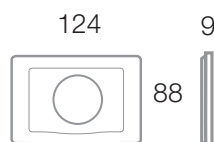

Scatole utilizzabili  
 Available boxes

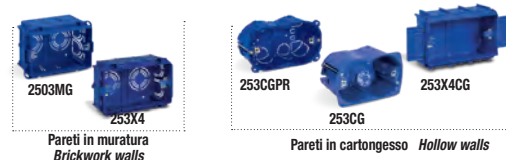

Pareti in muratura  
Brickwork walls

Pareti in cartongesso  
Hollow walls

Placche "England Style 44" in legno per scatola tonda e quadrata  
 "England Style 44" wood front plates for round and square box

Descrizione Description

Info

€

□

□



Per 2 moduli S44  
 For 2 S44 modules

■ 44PLT22NOC	1	1
Colore noce Walnut		

Supporto da utilizzare  
 To be used with

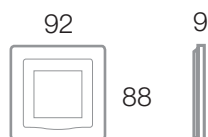

Scatole utilizzabili  
 Available boxes



Pareti in muratura  
Brickwork walls

Pareti in cartongesso  
Hollow walls

Le dimensioni, salvo diversamente specificato, sono in mm  
 Dimensions, except where otherwise specified, are in mm

□ Imballo Minimo pcs  
 Min. Packaging pcs

□ Imballo Standard pcs  
 Std. Packaging pcs





# Placche Legno

Wood front plates



Placche "England Style 44" in legno per scatola tonda e quadrata  
"England Style 44" wood front plates for round and square box

224

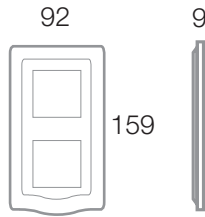

Supporto da utilizzare  
To be used with



n°2 44A02  
n°2 44A02SG  
n°2 44A02VT

Descrizione Description

Info

€

□

□

Per 4 (2+2) moduli S44  
For 4 (2+2) S44 modules

■ 44PLT24NOC  
Colore noce  
Walnut

1 1

Scatole utilizzabili  
Available boxes



2501



2501P



2502



251CG

Pareti in muratura  
Brickwork walls

Pareti in cartongesso  
Hollow walls

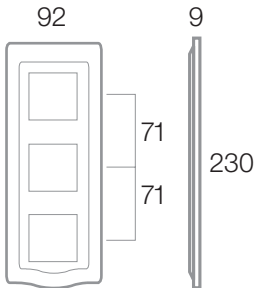

Supporto da utilizzare  
To be used with



n°3 44A02  
n°3 44A02SG  
n°3 44A02VT

Descrizione Description

Info

€

□

□

Per 6 (2+2+2) moduli S44  
For 6 (2+2+2) S44 modules

■ 44PLT26NOC  
Colore noce  
Walnut

1 1

Scatole utilizzabili  
Available boxes



2501



2501P



2502



251CG

Pareti in muratura  
Brickwork walls

Pareti in cartongesso  
Hollow walls

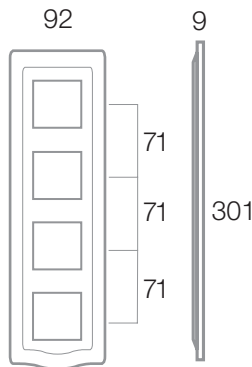

Supporto da utilizzare  
To be used with



n°4 44A02  
n°4 44A02SG  
n°4 44A02VT

Descrizione Description

Info

€

□

□

Per 8 (2+2+2+2) moduli S44  
For 8 (2+2+2+2) S44 modules

■ 44PLT28NOC  
Colore noce  
Walnut

6 6

Scatole utilizzabili  
Available boxes



2501



2501P



2502



251CG

Pareti in muratura  
Brickwork walls

Pareti in cartongesso  
Hollow walls



Per la disponibilità contattare  
la rete commerciale  
For availability please contact  
sales dept.



Disponibilità fino ad  
esaurimento scorte  
Available until stock out



Prodotto per scatola  
rettangolare inglese  
Product for British standard  
rectangular box



Prodotto  
per Export  
For Export  
only

Placche "England Style 44" in legno per scatola 3 moduli (interasse 83,5 mm)  
 "England Style 44" wood front plates for 3 modules box (fixing centre 83,5 mm)

BREVETTO AVE n° 247-208  
 MODELLO COMUNITARIO  
 AVE PATENT n° 247-208

225

Descrizione Description	Info	€	<input type="checkbox"/>	<input type="checkbox"/>
 <p><b>Per 3 moduli S44</b> For 3 S44 modules</p> <p>■ <b>44PLE3NOC</b> Colore noce Walnut</p>			1	1

Supporto da utilizzare  
To be used with



44A03

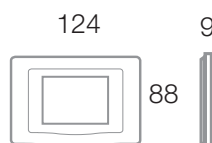

Scatole utilizzabili  
Available boxes



Pareti in muratura  
Brickwork walls



Pareti in cartongesso  
Hollow walls

Placche "England Style 44" in legno per scatola 4 moduli (interasse 108,5 mm)  
 "England Style 44" wood front plates for 4 modules box (fixing centre 108,5 mm)

Descrizione Description	Info	€	<input type="checkbox"/>	<input type="checkbox"/>
 <p><b>Per 4 moduli S44</b> For 4 S44 modules</p> <p>■ <b>44PLE4NOC</b> Colore noce Walnut</p>			1	1

Supporto da utilizzare  
To be used with



44A04

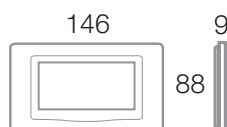

Scatole utilizzabili  
Available boxes

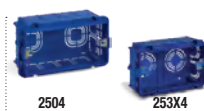

Pareti in muratura  
Brickwork walls



Pareti in cartongesso  
Hollow walls

Placche "England Style 44" in legno per scatola 6-7 moduli (interasse 158,5 mm)  
 "England Style 44" wood front plates for 6-7 modules box (fixing centre 158,5 mm)

Descrizione Description	Info	€	<input type="checkbox"/>	<input type="checkbox"/>
 <p><b>Per 7 moduli S44</b> For 7 S44 modules</p> <p>■ <b>44PLE7NOC</b> Colore noce Walnut</p>			1	1

Supporto da utilizzare  
To be used with



44A07

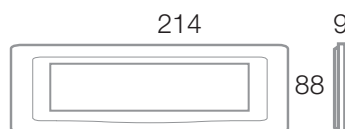

Scatole utilizzabili  
Available boxes



Pareti in muratura  
Brickwork walls



Pareti in cartongesso  
Hollow walls

Le dimensioni, salvo diversamente specificato, sono in mm  
 Dimensions, except where otherwise specified, are in mm

Imballo Minimo pcs  
Min. Packaging pcs

Imballo Standard pcs  
Std. Packaging pcs



# Placche Legno

Wood front plates



Placche "Vera 44" in legno per scatola tonda o quadrata  
"Vera 44" wood front plates for round or square box

226

2 MODULI 2 MODULES

Cod. Code

Colore Colour

Cornicetta Inner frame

Info

€

□

□



Per 2 moduli S44  
For 2 S44 modules

44PL22RS	Rovere sbiancato Whitened oak	Cromo Chrome	1	1
----------	----------------------------------	-----------------	---	---

Supporto da utilizzare  
To be used with



44A02  
44A02SG  
44A02VT

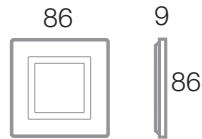

## Cornicette di ricambio Spare inner frames

Cod. Code	Colore Colour	Info	€	□	□
44CRV22B	Bianco Ral 9010 Ral 9010 white	2	50		
44CRV22N	Grigio scuro lucido Polished dark grey	2	50		
44CRV22CR	Cromo Chrome	2	50		

## Placche "Vera 44" in legno per scatola rettangolare "Vera 44" wood front plates for rectangular box

Cod. Code	Colore Colour	Info	€	□	□
44PL3RS	Rovere sbiancato Whitened oak	Cromo Chrome	1	1	



Per 3 moduli S44  
For 3 S44 modules

Supporto da utilizzare  
To be used with



44A03



## Cornicette di ricambio Spare inner frames

Cod. Code	Colore Colour	Info	€	□	□
44CRV3B	Bianco Ral 9010 Ral 9010 white	2	50		
44CRV3N	Grigio scuro lucido Polished dark grey	2	50		
44CRV3CR	Cromo Chrome	2	50		



Per la disponibilità contattare la rete commerciale  
For availability please contact sales dept.



Disponibilità fino ad esaurimento scorte  
Available until stock out



Prodotto per scatola rettangolare inglese  
Product for British standard rectangular box



Prodotto per Export  
For Export only

**Placche "Vera 44" in legno per scatola 4 moduli (interasse 108,5 mm)**  
**"Vera 44" wood front plates for rectangular 4 modules box (fixing centres 108,5 mm)**

Cod. Code	Colore Colour	Cornicetta Inner frame	Info	€	<input type="checkbox"/>	<input type="checkbox"/>
						
<b>Per 4 moduli S44</b> <i>For 4 S44 modules</i>						
44PL4RS	Rovere sbiancato <i>Whitened oak</i>	Cromo <i>Chrome</i>		1	1	

Supporto da utilizzare  
To be used with



44A04



**Cornicette di ricambio Spare inner frames**

Cod. Code	Colore Colour	Info	€	<input type="checkbox"/>	<input type="checkbox"/>
					
44CRV4B	Bianco Ral 9010 <i>Ral 9010 white</i>		2	50	
44CRV4N	Grigio scuro lucido <i>Polished dark grey</i>		2	50	
44CRV4CR	Cromo <i>Chrome</i>		2	50	

**Placche "Vera 44" in legno per scatola 7 moduli (interasse 158,5 mm)**  
**"Vera 44" wood front plates for rectangular 7 modules box (fixing centres 158,5 mm)**

Cod. Code	Colore Colour	Cornicetta Inner frame	Info	€	<input type="checkbox"/>	<input type="checkbox"/>
						
<b>Per 7 moduli S44</b> <i>For 7 S44 modules</i>						
44PL7RS	Rovere sbiancato <i>Whitened oak</i>	Cromo <i>Chrome</i>		1	1	

Supporto da utilizzare  
To be used with



44A07

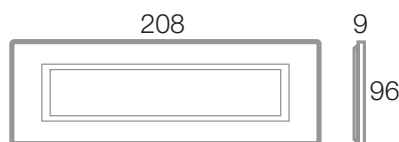

**Cornicette di ricambio Spare inner frames**

Cod. Code	Colore Colour	Info	€	<input type="checkbox"/>	<input type="checkbox"/>
					
44CRV7B	Bianco Ral 9010 <i>Ral 9010 white</i>		2	30	
44CRV7N	Grigio scuro lucido <i>Polished dark grey</i>		2	30	
44CRV7CR	Cromo <i>Chrome</i>		2	30	

# Placche

## Front Plates

BREVETTO AVE N° 206  
AVE PATENT N° 206

Design:  
L. Merletti

228

I colori delle placche "Zama 44" per scatola rettangolare  
"Zama 44" front plates colours for rectangular box



**44P93ALS**  
Alluminio naturale  
*Natural aluminium*



**44P93AO**  
Argento opaco  
*Matt silver*



**44P93B**  
Bianco RAL 9010  
*RAL 9010 white*



**44P93BMC**  
Bianco lucido micalizzato  
*Micalized polished white*



**44P93GF**  
Grafite  
*Graphite*



**44P93GSM**  
Grigio scuro metallizzato  
*Metallic dark grey*



**44P93GTK**  
Grigio Tekla  
*Tekla grey*



**44P93NAL**  
Nero assoluto lucido  
*Polished absolute black*



**44P93NCS**  
Nichel spazzolato  
*Brushed nickel*



**44P93OT**  
Ottone lucido  
*Polished brass*

**I formati placche ZAMA 44**  
**ZAMA 44 front plates size**

**Metallo Metal**

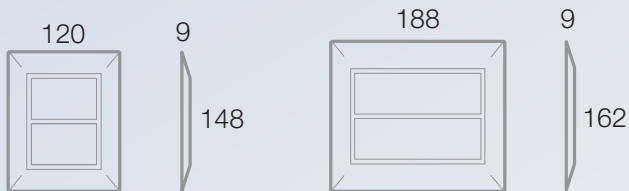
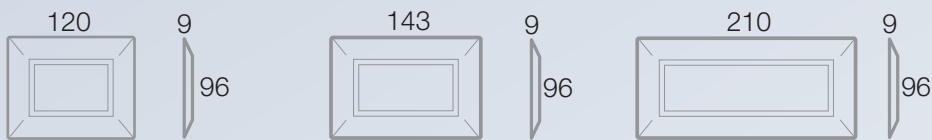
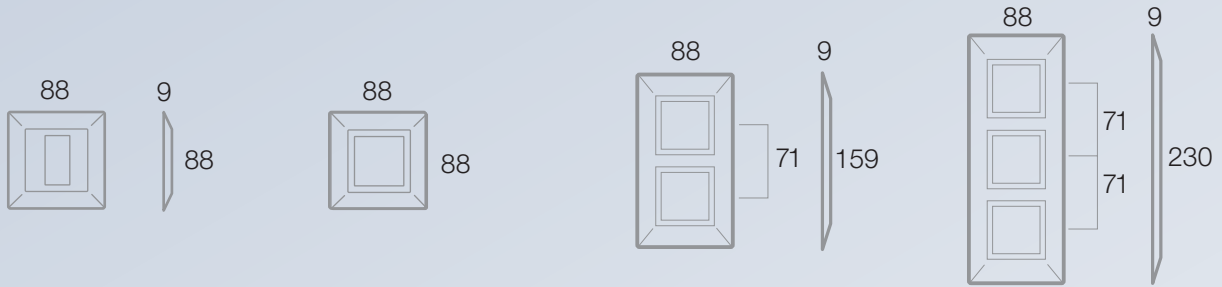

**Plastica Moulded**





# Placche Tecnopolimero

Moulded front plates



Placche "Pyramis 44" in tecnopolimero per scatola tonda o quadrata  
"Pyramis 44" moulded front plates for round or square box

230

Cod. Code

Colore Colour

Cornicetta Inner frame

Info

€

□

□



Per 2 comandi standard 44  
For 2 S44 standard controls

44PTK22B

Bianco Ral 9010  
Ral 9010 white

Bianco Ral 9010  
Ral 9010 white

1 30

Supporto da utilizzare  
To be used with



44A02  
44A02SG  
44A02VT

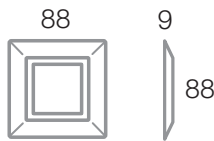

Scatole utilizzabili  
Available boxes



2501



2501P



2502



251CG

Pareti in muratura  
Brickwork walls

Pareti in cartongesso  
Hollow walls

## Cornicette di ricambio Spare inner frames

Cod. Code

Colore Colour

Info

€

□

□



44CRK22N

Grigio scuro lucido  
Polished dark grey

2 50



Per la disponibilità contattare  
la rete commerciale  
For availability please contact  
sales dept.



Disponibilità fino ad  
esaurimento scorte  
Available until stock out



Prodotto per scatola  
rettangolare inglese  
Product for British standard  
rectangular box



Prodotto  
per Export  
For Export  
only

# Placche Metallo

Metal front plates



Placche "Zama 44" in metallo per scatola tonda o quadrata  
"Zama 44" metal front plates for round or square box

Cod. Code	Colore Colour	Cornicetta Inner frame	Info	€	□	□
<b>Per 2 comandi standard 44</b> <i>For 2 S44 standard controls</i>						
44PK22ALS	Alluminio naturale <i>Natural aluminium</i>	Cromo <i>Chrome</i>		1	15	
44PK22A0	Argento opaco <i>Matt silver</i>	Grigio scuro lucido <i>Polished dark grey</i>		1	15	
44PK22B	Bianco Ral 9010 <i>Ral 9010 white</i>	Bianco Ral 9010 <i>Ral 9010 white</i>		1	15	
44PK22BMC	Bianco lucido micalizzato <i>Micalized polished white</i>	Bianco Ral 9010 <i>Ral 9010 white</i>		1	15	
44PK22GF	Grafite <i>Graphite</i>	Grigio scuro lucido <i>Polished dark grey</i>		1	15	
44PK22GSM	Grigio scuro metallizzato <i>Metallic dark grey</i>	Cromo <i>Chrome</i>		1	15	
44PK22GTK	Grigio Tekla <i>Tekla grey</i>	Cromo <i>Chrome</i>		1	15	
44PK22NAL	Nero assoluto lucido <i>Polished absolute black</i>	Cromo <i>Chrome</i>		1	15	
44PK22NCS	Nichel spazzolato <i>Brushed nickel</i>	Grigio scuro lucido <i>Polished dark grey</i>		1	15	
44PK220T	Ottone lucido <i>Polished brass</i>	Cromo <i>Chrome</i>		1	15	



Sistema 45

Supporto da utilizzare  
To be used with



44A02  
44A02SG  
44A02VT

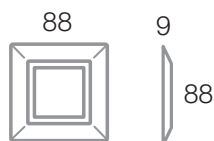

Scatole utilizzabili  
Available boxes



Pareti in muratura  
Brickwork walls

Pareti in cartongesso  
Hollow walls

## Cornicette di ricambio Spare inner frames

Cod. Code	Colore Colour	Info	€	□	□
44CRK22N	Grigio scuro lucido <i>Polished dark grey</i>		2	50	



Le dimensioni, salvo diversamente specificato, sono in mm  
Dimensions, except where otherwise specified, are in mm

□ Imballo Minimo pcs  
Min. Packaging pcs

□ Imballo Standard pcs  
Std. Packaging pcs





# Placche Metallo

Metal front plates



Placche "Zama 44" in metallo per scatola tonda o quadrata  
"Zama 44" metal front plates for round or square box

232

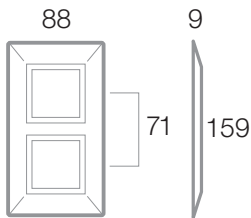

Cod. Code	Colore Colour	Cornicetta Inner frame	Info	€	□	□
<b>Per 4 comandi standard 44</b> <b>For 4 S44 standard controls</b>						
44PK24ALS	Alluminio naturale Natural aluminium	Cromo Chrome		1	10	
44PK24B	Bianco Ral 9010 Ral 9010 white	Bianco Ral 9010 Ral 9010 white		1	10	
44PK24BMC	Bianco lucido micalizzato Micalized polished white	Bianco Ral 9010 Ral 9010 white		1	10	
44PK24GF	Grafite Graphite	Grigio scuro lucido Polished dark grey		1	10	
44PK24GSM	Grigio scuro metallizzato Metallic dark grey	Cromo Chrome		1	10	
44PK24GTK	Grigio Tekla Tekla grey	Cromo Chrome		1	10	
44PK24NAL	Nero assoluto lucido Polished absolute black	Cromo Chrome		1	10	
44PK24NCS	Nichel spazzolato Brushed nickel	Grigio scuro lucido Polished dark grey		1	10	
44PK24OT	Ottone lucido Polished brass	Cromo Chrome		1	10	

## Soluzione Installativa Installation solution

Scatole  
Boxes

Supporto da utilizzare  
To be used with



n° 2 44A02  
n° 2 44A02SG  
n° 2 44A02VT



Standard Export

2502

2501

2501P

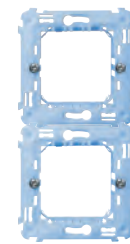

Supporti accoppiabili  
Frames that can be coupled



Placca  
Front plate

## Cornicette di ricambio Spare inner frames

Cod. Code	Colore Colour	Info	€	□	□
44CRK22N	Grigio scuro lucido Polished dark grey		2	50	



Per la disponibilità contattare la rete commerciale  
For availability please contact sales dept.



Disponibilità fino ad esaurimento scorte  
Available until stock out



Prodotto per scatola rettangolare inglese  
Product for British standard rectangular box



Prodotto per Export  
For Export only

Placche "Zama 44" in metallo per scatola tonda o quadrata  
 "Zama 44" metal front plates for round or square box

Cod. Code	Colore Colour	Cornicetta Inner frame	Info	€	□	□
<b>Per 6 comandi standard 44</b> <i>For 6 S44 standard controls</i>						
44PK26ALS	Alluminio naturale <i>Natural aluminium</i>	Cromo <i>Chrome</i>		1	5	
44PK26B	Bianco Ral 9010 <i>Ral 9010 white</i>	Bianco Ral 9010 <i>Ral 9010 white</i>		1	5	
44PK26BMC	Bianco lucido micallizzato <i>Micalized polished white</i>	Bianco Ral 9010 <i>Ral 9010 white</i>		1	5	
44PK26GF	Grafite <i>Graphite</i>	Grigio scuro lucido <i>Polished dark grey</i>		1	5	
44PK26GSM	Grigio scuro metallizzato <i>Metallic dark grey</i>	Cromo <i>Chrome</i>		1	5	
44PK26GTK	Grigio Tekla <i>Tekla grey</i>	Cromo <i>Chrome</i>		1	5	
44PK26NAL	Nero assoluto lucido <i>Polished absolute black</i>	Cromo <i>Chrome</i>		1	5	
44PK26NCS	Nichel spazzolato <i>Brushed nickel</i>	Grigio scuro lucido <i>Polished dark grey</i>		1	5	
44PK260T	Ottone lucido <i>Polished brass</i>	Cromo <i>Chrome</i>		1	5	

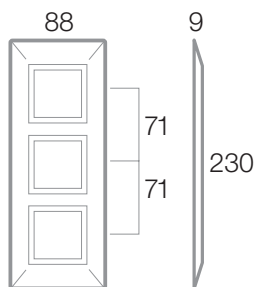

**Soluzione Installativa** *Installation solution*

Scatole  
*Boxes*



Standard Export

2502

2501

2501P



Supporti accoppiabili  
*Frames that can be coupled*



Placca  
*Front plate*

Supporto da utilizzare  
*To be used with*



- n° 3 44A02
- n° 3 44A02SG
- n° 3 44A02VT

**Cornicette di ricambio** *Spare inner frames*

Cod. Code	Colore Colour	Info	€	□	□
44CRK22N	Grigio scuro lucido <i>Polished dark grey</i>		2	50	



Le dimensioni, salvo diversamente specificato, sono in mm  
 Dimensions, except where otherwise specified, are in mm

□ Imballo Minimo pcs  
 Min. Packaging pcs

□ Imballo Standard pcs  
 Std. Packaging pcs



# Placche Metallo

Metal front plates



Placche "Zama 44" in metallo per scatola 3 moduli (interasse 83,5 mm)  
"Zama 44" metal front plates for 3 modules box (fixing centres 83,5 mm)

234



Cod. Code	Colore Colour	Cornicetta Inner frame	Info	€	□	□
<b>Per 3 comandi standard 44</b> <i>For 3 S44 standard controls</i>						
44P93ALS	Alluminio naturale <i>Natural aluminium</i>	Cromo <i>Chrome</i>	1	12		
44P93AO	Argento opaco <i>Matt silver</i>	Grigio scuro lucido <i>Polished dark grey</i>	1	12		
44P93B	Bianco Ral 9010 <i>Ral 9010 white</i>	Bianco Ral 9010 <i>Ral 9010 white</i>	1	12		
44P93BMC	Bianco lucido micalizzato <i>Micalized polished white</i>	Bianco Ral 9010 <i>Ral 9010 white</i>	1	12		
44P93GF	Grafite <i>Graphite</i>	Grigio scuro lucido <i>Polished dark grey</i>	1	12		
44P93GSM	Grigio scuro metallizzato <i>Metallic dark grey</i>	Cromo <i>Chrome</i>	1	12		
44P93GTK	Grigio Tekla <i>Tekla grey</i>	Cromo <i>Chrome</i>	1	12		
44P93NAL	Nero assoluto lucido <i>Polished absolute black</i>	Cromo <i>Chrome</i>	1	12		
44P93NCS	Nichel spazzolato <i>Brushed nickel</i>	Grigio scuro lucido <i>Polished dark grey</i>	1	12		
44P93OT	Ottone lucido <i>Polished brass</i>	Cromo <i>Chrome</i>	1	12		

Supporto da utilizzare  
To be used with



44A03

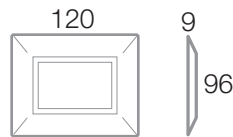

Scatole utilizzabili  
Available boxes



2503MG

253X4

Pareti in muratura  
Brickwork walls



2530GPR

2530G

253X4CG

Pareti in cartongesso  
Hollow walls

## Cornicette di ricambio Spare inner frames



Cod. Code	Colore Colour	Info	€	□	□
44CR3N	Grigio scuro lucido <i>Polished dark grey</i>	2	50		
44CR3CR	Cromo <i>Chrome</i>	2	50		



Per la disponibilità contattare la rete commerciale  
For availability please contact sales dept.



Disponibilità fino ad esaurimento scorte  
Available until stock out



Prodotto per scatola rettangolare inglese  
Product for British standard rectangular box



Prodotto per Export  
For Export only

Placche "Zama 44" in metallo per scatola 4 moduli (interasse 108,5 mm)  
 "Zama 44" metal front plates for 4 modules box (fixing centres 108,5 mm)

4 MODULI 4 MODULES	Cod. Code	Colore Colour	Cornicetta Inner frame	Info	€	□	□
<b>Per 4 comandi standard 44</b> <i>For 4 S44 standard controls</i>							
	44P94ALS	Alluminio naturale <i>Natural aluminium</i>	Cromo <i>Chrome</i>		1	10	
	44P94AO	Argento opaco <i>Matt silver</i>	Grigio scuro lucido <i>Polished dark grey</i>		1	10	
	44P94B	Bianco Ral 9010 <i>Ral 9010 white</i>	Bianco Ral 9010 <i>Ral 9010 white</i>		1	10	
	44P94BMC	Bianco lucido micalizzato <i>Micalized polished white</i>	Bianco Ral 9010 <i>Ral 9010 white</i>		1	10	
	44P94GF	Grafite <i>Graphite</i>	Grigio scuro lucido <i>Polished dark grey</i>		1	10	
	44P94GSM	Grigio scuro metallizzato <i>Metallic dark grey</i>	Cromo <i>Chrome</i>		1	10	
	44P94GTK	Grigio Tekla <i>Tekla grey</i>	Cromo <i>Chrome</i>		1	10	
	44P94NAL	Nero assoluto lucido <i>Polished absolute black</i>	Cromo <i>Chrome</i>		1	10	
	44P94NCS	Nichel spazzolato <i>Brushed nickel</i>	Grigio scuro lucido <i>Polished dark grey</i>		1	10	
	44P94OT	Ottone lucido <i>Polished brass</i>	Cromo <i>Chrome</i>		1	10	

235



Sistema 45

Supporto da utilizzare  
To be used with

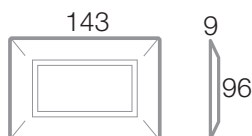

Scatole utilizzabili  
Available boxes



Pareti in muratura Brickwork walls



Pareti in cartongesso Hollow walls

Cornicette di ricambio Spare inner frames

	Cod. Code	Colore Colour	Info	€	□	□
	44CR4N	Grigio scuro lucido <i>Polished dark grey</i>		2	50	
	44CR4CR	Cromo <i>Chrome</i>		2	50	

Le dimensioni, salvo diversamente specificato, sono in mm  
Dimensions, except where otherwise specified, are in mm

□ Imballo Minimo pcs  
Min. Packaging pcs

□ Imballo Standard pcs  
Std. Packaging pcs



# Placche Metallo

Metal front plates



Placche "Zama 44" in metallo per scatola 7 moduli (interasse 158,5 mm)  
"Zama 44" metal front plates for 7 modules box (fixing centres 158,5 mm)

236



Cod. Code	Colore Colour	Cornicetta Inner frame	Info	€	□	□
<b>Per 7 comandi standard 44</b> <i>For 7 S44 standard controls</i>						
44P97ALS	Alluminio naturale <i>Natural aluminium</i>	Cromo <i>Chrome</i>	1	5		
44P97AO	Argento opaco <i>Matt silver</i>	Grigio scuro lucido <i>Polished dark grey</i>	1	5		
44P97B	Bianco Ral 9010 <i>Ral 9010 white</i>	Bianco Ral 9010 <i>Ral 9010 white</i>	1	5		
44P97BMC	Bianco lucido micalizzato <i>Micalized polished white</i>	Bianco Ral 9010 <i>Ral 9010 white</i>	1	5		
44P97GF	Grafite <i>Graphite</i>	Grigio scuro lucido <i>Polished dark grey</i>	1	5		
44P97GSM	Grigio scuro metallizzato <i>Metallic dark grey</i>	Cromo <i>Chrome</i>	1	5		
44P97GTK	Grigio Tekla <i>Tekla grey</i>	Cromo <i>Chrome</i>	1	5		
44P97NAL	Nero assoluto lucido <i>Polished absolute black</i>	Cromo <i>Chrome</i>	1	5		
44P97NCS	Nichel spazzolato <i>Brushed nickel</i>	Grigio scuro lucido <i>Polished dark grey</i>	1	5		
44P97OT	Ottone lucido <i>Polished brass</i>	Cromo <i>Chrome</i>	1	5		

Supporto da utilizzare  
*To be used with*



44A07

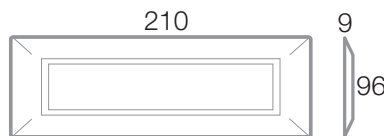

Scatole utilizzabili  
*Available boxes*



Pareti in muratura *Brickwork walls*

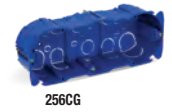

Pareti in cartongesso *Hollow walls*

## Cornicette di ricambio *Spare inner frames*

Cod. Code	Colore Colour	Info	€	□	□
44CR7N	Grigio scuro lucido <i>Polished dark grey</i>	2	30		
44CR7CR	Cromo <i>Chrome</i>	2	30		



Per la disponibilità contattare la rete commerciale  
For availability please contact sales dept.



Disponibilità fino ad esaurimento scorte  
Available until stock out



Prodotto per scatola rettangolare inglese  
Product for British standard rectangular box



Prodotto per Export  
For Export only

Placche "Zama 44" in metallo per scatola BL02..  
 "Zama 44" metal front plates for BL02.. box

237



Cod. Code	Colore Colour	Cornicetta Inner frame	Info	€	<input type="checkbox"/>	<input type="checkbox"/>
<b>Per 6(3+3) comandi standard 44</b> <i>For 6(3+3) S44 standard controls</i>						
44P933B	Bianco Ral 9010 <i>Ral 9010 white</i>	Bianco Ral 9010 <i>Ral 9010 white</i>	1	1		
44P933GSM	Grigio scuro metallizzato <i>Metallic dark grey</i>	Cromo <i>Chrome</i>	1	1		

Supporto da utilizzare  
 To be used with

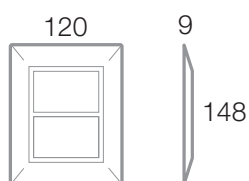

Placche "Zama 44" in metallo per scatola BL05.. "Zama 44" metal front plates for BL05.. box



Cod. Code	Colore Colour	Cornicetta Inner frame	Info	€	<input type="checkbox"/>	<input type="checkbox"/>
<b>Per 12(6+6) comandi standard 44</b> <i>For 12(6+6) S44 standard controls</i>						
44P912B	Bianco Ral 9010 <i>Ral 9010 white</i>	Bianco Ral 9010 <i>Ral 9010 white</i>	1	1		
44P912GSM	Grigio scuro metallizzato <i>Metallic dark grey</i>	Cromo <i>Chrome</i>	1	1		

Supporto da utilizzare  
 To be used with

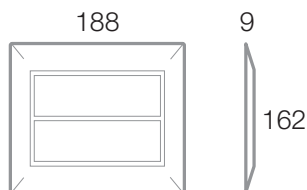

# Placche

## Front Plates

238

BREVETTO AVE N° 206  
AVE PATENT N° 206



Design:  
L. Merletti

Gamma "EASY Smart 44" nelle nuove colorazioni con finiture opache, per scatola rettangolare  
"EASY Smart 44" range in the new colours with matt finishes, for rectangular box



**44PSME3BO**  
Bianco Whitek  
*Whitek white*



**44PSME3GO**  
Grigio finitura opaca  
*Brushed satin steel*



**44PSME3GTK**  
Grigio Tekla  
*Tekla grey*



**44PSME3TO**  
Tortora finitura opaca  
*Matte dove grey*



**44PSME3ORO**  
Oro finitura opaca  
*Matte gold*



**44PSME3BRZ**  
Bronzo opaco  
*Brushed steel anthracite*



**44PSME3TCO**  
Terracotta finitura opaca  
*Matte terracotta*

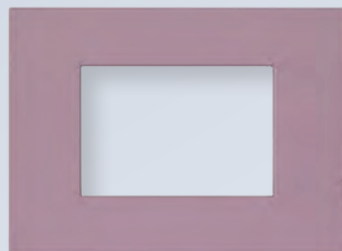

**44PSME3VIO**  
Viola finitura opaca  
*Matte Purple*

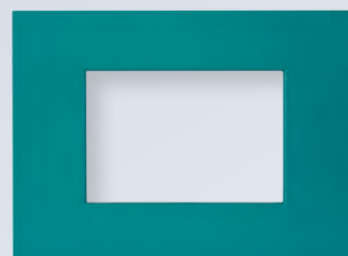

**44PSME30TN**  
Ottanio finitura opaca  
*Matte Teal*

**I formati placche "EASY Smart 44"**  
*"EASY Smart 44" front plates size*

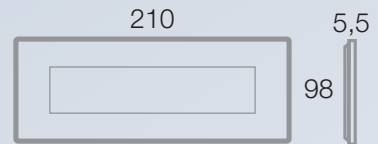
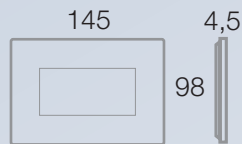
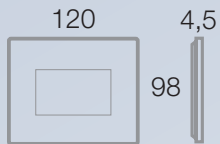





# Placche Tecnopolimero

Tecnopolimero front plates



Placche "EASY Smart 44" in tecnopolimero per scatola 3 moduli (interasse 83,5 mm)  
"EASY Smart 44" metal front plates for rectangular 3 modules box (fixing centres 83,5 mm)

240

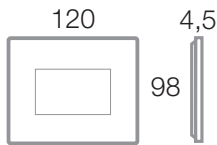

Supporto da utilizzare  
To be used with



44A03SM

Descrizione Description

Info

€

□

□

Per 3 comandi standard 44  
For 3 S44 standard controls

□ 44PSME3B0

Bianco Whitek finitura opaca  
Matt Whitek white



1 25

■ 44PSME3BRZ

Bronzo finitura opaca  
Matt steel anthracite



1 25

■ 44PSME3G0

Grigio finitura opaca  
Matt satin steel



1 25

■ 44PSME3GTK

Grigio Tekla finitura opaca  
Matt Tekla grey



1 25

■ 44PSME30RO

Oro finitura opaca  
Matt gold



1 25

■ 44PSME30TN

Ottanio finitura opaca  
Matt teal



1 25

■ 44PSME3TCO

Terracotta finitura opaca  
Matt terracotta



1 25

■ 44PSME3TO

Tortora finitura opaca  
Matt dove grey



1 25

■ 44PSME3VIO

Viola finitura opaca  
Matt purple



1 25

Placche "EASY Smart 44" in tecnopolimero per scatola 4 moduli (interasse 108,5 mm)  
"EASY Smart 44" metal front plates for rectangular 4 modules box (fixing centres 108,5 mm)

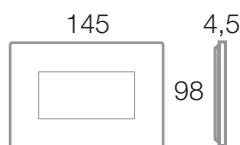

Supporto da utilizzare  
To be used with



44A04SM

Descrizione Description

Info

€

□

□

Per 4 comandi standard 44  
For 4 S44 standard controls

□ 44PSME4B0

Bianco Whitek finitura opaca  
Matt Whitek white



1 20

■ 44PSME4BRZ

Bronzo finitura opaca  
Matt steel anthracite



1 20

■ 44PSME4G0

Grigio finitura opaca  
Matt satin steel



1 20

■ 44PSME4GTK

Grigio Tekla finitura opaca  
Matt Tekla grey



1 20

■ 44PSME40RO

Oro finitura opaca  
Matt gold



1 20



Per la disponibilità contattare  
la rete commerciale  
For availability please contact  
sales dept.



Disponibilità fino ad  
esaurimento scorte  
Available until stock out



Prodotto per scatola  
rettangolare inglese  
Product for British standard  
rectangular box



Prodotto  
per Export  
For Export  
only

Placche "EASY Smart 44" in tecnopolimero per scatola 4 moduli (interasse 108,5 mm)  
 "EASY Smart 44" metal front plates for rectangular 4 modules box (fixing centres 108,5 mm)

		Descrizione Description	Info	€	□	□																						
		<b>Per 4 comandi standard 44</b> <b>For 4 S44 standard controls</b>																										
		<table border="1"> <tr> <td><b>44PSME40TN</b> Ottanio finitura opaca <i>Matt teal</i></td> <td></td> <td>1</td> <td>20</td> <td></td> <td></td> </tr> <tr> <td><b>44PSME4TCO</b> Terracotta finitura opaca <i>Matt terracotta</i></td> <td></td> <td>1</td> <td>20</td> <td></td> <td></td> </tr> <tr> <td><b>44PSME4TO</b> Tortora finitura opaca <i>Matt dove grey</i></td> <td></td> <td>1</td> <td>20</td> <td></td> <td></td> </tr> <tr> <td><b>44PSME4VIO</b> Viola finitura opaca <i>Matt purple</i></td> <td></td> <td>1</td> <td>20</td> <td></td> <td></td> </tr> </table>					<b>44PSME40TN</b> Ottanio finitura opaca <i>Matt teal</i>		1	20			<b>44PSME4TCO</b> Terracotta finitura opaca <i>Matt terracotta</i>		1	20			<b>44PSME4TO</b> Tortora finitura opaca <i>Matt dove grey</i>		1	20			<b>44PSME4VIO</b> Viola finitura opaca <i>Matt purple</i>		1	20
<b>44PSME40TN</b> Ottanio finitura opaca <i>Matt teal</i>		1	20																									
<b>44PSME4TCO</b> Terracotta finitura opaca <i>Matt terracotta</i>		1	20																									
<b>44PSME4TO</b> Tortora finitura opaca <i>Matt dove grey</i>		1	20																									
<b>44PSME4VIO</b> Viola finitura opaca <i>Matt purple</i>		1	20																									
<b>Supporto da utilizzare</b> <b>To be used with</b>																												
<b>44A04SM</b>																												



Placche "EASY Smart 44" in tecnopolimero per scatola 7 moduli (interasse 158,5 mm)  
 "EASY Smart 44" metal front plates for rectangular 7 modules box (fixing centres 158,5 mm)

		Descrizione Description	Info	€	□	□																																																				
		<b>Per 7 comandi standard 44</b> <b>For 7 S44 standard controls</b>																																																								
		<table border="1"> <tr> <td><b>44PSME7B0</b> Bianco Whitek finitura opaca <i>Matt Whitek white</i></td> <td></td> <td>1</td> <td>15</td> <td></td> <td></td> </tr> <tr> <td><b>44PSME7BRZ</b> Bronzo finitura opaca <i>Matt steel anthracite</i></td> <td></td> <td>1</td> <td>15</td> <td></td> <td></td> </tr> <tr> <td><b>44PSME7GO</b> Grigio finitura opaca <i>Matt satin steel</i></td> <td></td> <td>1</td> <td>15</td> <td></td> <td></td> </tr> <tr> <td><b>44PSME7GTK</b> Grigio Tekla finitura opaca <i>Matt Tekla grey</i></td> <td></td> <td>1</td> <td>15</td> <td></td> <td></td> </tr> <tr> <td><b>44PSME7ORO</b> Oro finitura opaca <i>Matt gold</i></td> <td></td> <td>1</td> <td>15</td> <td></td> <td></td> </tr> <tr> <td><b>44PSME70TN</b> Ottanio finitura opaca <i>Matt teal</i></td> <td></td> <td>1</td> <td>15</td> <td></td> <td></td> </tr> <tr> <td><b>44PSME7TCO</b> Terracotta finitura opaca <i>Matt terracotta</i></td> <td></td> <td>1</td> <td>15</td> <td></td> <td></td> </tr> <tr> <td><b>44PSME7TO</b> Tortora finitura opaca <i>Matt dove grey</i></td> <td></td> <td>1</td> <td>15</td> <td></td> <td></td> </tr> <tr> <td><b>44PSME7VIO</b> Viola finitura opaca <i>Matt purple</i></td> <td></td> <td>1</td> <td>15</td> <td></td> <td></td> </tr> </table>					<b>44PSME7B0</b> Bianco Whitek finitura opaca <i>Matt Whitek white</i>		1	15			<b>44PSME7BRZ</b> Bronzo finitura opaca <i>Matt steel anthracite</i>		1	15			<b>44PSME7GO</b> Grigio finitura opaca <i>Matt satin steel</i>		1	15			<b>44PSME7GTK</b> Grigio Tekla finitura opaca <i>Matt Tekla grey</i>		1	15			<b>44PSME7ORO</b> Oro finitura opaca <i>Matt gold</i>		1	15			<b>44PSME70TN</b> Ottanio finitura opaca <i>Matt teal</i>		1	15			<b>44PSME7TCO</b> Terracotta finitura opaca <i>Matt terracotta</i>		1	15			<b>44PSME7TO</b> Tortora finitura opaca <i>Matt dove grey</i>		1	15			<b>44PSME7VIO</b> Viola finitura opaca <i>Matt purple</i>		1	15
<b>44PSME7B0</b> Bianco Whitek finitura opaca <i>Matt Whitek white</i>		1	15																																																							
<b>44PSME7BRZ</b> Bronzo finitura opaca <i>Matt steel anthracite</i>		1	15																																																							
<b>44PSME7GO</b> Grigio finitura opaca <i>Matt satin steel</i>		1	15																																																							
<b>44PSME7GTK</b> Grigio Tekla finitura opaca <i>Matt Tekla grey</i>		1	15																																																							
<b>44PSME7ORO</b> Oro finitura opaca <i>Matt gold</i>		1	15																																																							
<b>44PSME70TN</b> Ottanio finitura opaca <i>Matt teal</i>		1	15																																																							
<b>44PSME7TCO</b> Terracotta finitura opaca <i>Matt terracotta</i>		1	15																																																							
<b>44PSME7TO</b> Tortora finitura opaca <i>Matt dove grey</i>		1	15																																																							
<b>44PSME7VIO</b> Viola finitura opaca <i>Matt purple</i>		1	15																																																							
<b>Supporto da utilizzare</b> <b>To be used with</b>																																																										
<b>44A07SM</b>																																																										

# Placche

## Front Plates

BREVETTO AVE N° 205-209-212  
AVE PATENT N° 205-209-212



Design:  
L. Merletti

242

Placche in tecnopolimero "Young 44" per scatola rettangolare  
"Young 44 moulded" front plates for rectangular box



**44PJ03B**  
Bianco  
White



**44PJ03GSO**  
Gesso  
Plaster



**44PJ03BT**  
Bianco totale  
Total white



**44PJ03BO**  
Bianco opaco  
Matt white



**44PJ03AVR**  
Avorio  
Ivory



**44PJ03B/3D**  
Bianco 3D  
3D white



**44PJ03BEG/3D**  
Beige spazzolato 3D  
3D brushed beige



**44PJ03TO**  
Tortora opaco  
Matt dove grey



**44PJ03SAL**  
Salvia  
Sage



**44PJ03GOLD**  
Oro  
Gold



**44PJ03SA**  
Sabbia  
Sand



**44PJ03AVN**  
Avana  
Havana

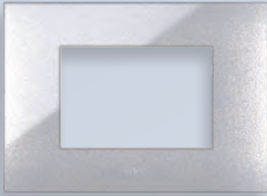

**44PJ03GM**  
Grigio metallizzato  
*Metallic grey*



**44PJ03CNR**  
Cenere  
*Ash*



**44PJ03GO**  
Grigio opaco  
*Matt grey*



**44PJ03GTK**  
Grigio Tekla  
*Tekla grey*



**44PJ03GTKT**  
Grigio antracite  
*Anthracite grey*



**44PJ03NAL**  
Nero assoluto  
*Absolute black*



**44PJ030NC/3D**  
Onice 3D  
*3D onyx*



**44PJ03RD**  
Radica opaco  
*Matt briarwood*



**44PJ03CBS/3D**  
Carbon scuro 3D  
*3D dark carbon*



**44PJ03RA**  
Ottone  
*Brass*

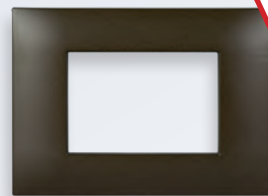

**44PJ03BR**  
Bronzo  
*Bronze*



# Placche Tecnopolimero

Tecnopolimero front plates



Placche "Young Touch" in tecnopolimero per scatola tonda o quadrata  
"Young Touch" moulded front plates for square or round box

244

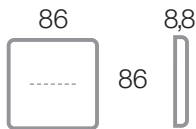

Supporto da utilizzare  
To be used with



44A02  
44A02SG  
44A02VT

Descrizione Description

Info

€

□

□

Fino a 2 comandi "a scomparsa"  
Up to 2 "hidden" controls

■ 44PJTC22AVN Avana Havana	1	25
■ 44PJTC22AVR Avorio Ivory	1	25
□ 44PJTC22B Bianco White	1	25
□ 44PJTC22BT Bianco totale Total white	1	25
■ 44PJTC22CNR Cenere Ash	1	25
■ 44PJTC22GM Grigio metallizzato Metallic grey	1	25
■ 44PJTC22GOLD Oro Gold	1	25
□ 44PJTC22GSO Gesso Plaster	1	25
■ 44PJTC22GTK Grigio Tekla Tekla grey	1	25
■ 44PJTC22GTKT Grigio antracite Anthracite grey	1	25
■ 44PJTC22NAL Nero assoluto Absolute black	1	25
■ 44PJTC22SA Sabbia Sand	1	25
■ 44PJTC22SAL Salvia Sage	1	25
□ 44PJTC22B/3D Bianco 3D 3D white	1	25
■ 44PJTC22BEG/3D Beige spazzolato 3D 3D brushed beige	1	25
■ 44PJTC22CBS/3D Carbon scuro 3D 3D dark carbon	1	25

**Nota:** assicurarsi che la placca sia perfettamente aderente agli apparecchi di comando "a scomparsa"

**Note:** make sure that the front plate sticks perfectly to the "hidden" control devices



Per la disponibilità contattare la rete commerciale  
For availability please contact sales dept.



Disponibilità fino ad esaurimento scorte  
Available until stock out



Prodotto per scatola rettangolare inglese  
Product for British standard rectangular box



Prodotto per Export  
For Export only

Placche "Young Touch" in tecnopolimero per scatola 3 moduli (interasse 83,5 mm)  
 "Young Touch" moulded front plates for rectangular 3 modules box (fixing centres 83,5 mm)

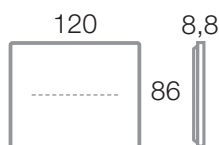

Supporto da utilizzare  
To be used with



44A03

Descrizione Description

Info

€

□

□

245

Fino a 3 comandi "a scomparsa"  
Up to 3 "hidden" controls

■ 44PJTC3AVN	1	25
Avana Havana		
■ 44PJTC3AVR	1	25
Avorio Ivory		
□ 44PJTC3B	1	25
Bianco White		
□ 44PJTC3BT	1	25
Bianco totale Total white		
■ 44PJTC3CNR	1	25
Cenere Ash		
■ 44PJTC3GM	1	25
Grigio metallizzato Metallic grey		
■ 44PJTC3GOLD	1	25
Oro Gold		
□ 44PJTC3GSO	1	25
Gesso Plaster		
■ 44PJTC3GTK	1	25
Grigio Tekla Tekla grey		
■ 44PJTC3GTKT	1	25
Grigio antracite Anthracite grey		
■ 44PJTC3NAL	1	25
Nero assoluto Absolute black		
■ 44PJTC3SA	1	25
Sabbia Sand		
■ 44PJTC3SAL	1	25
Salvia Sage		
□ 44PJTC3B/3D	1	25
Bianco 3D 3D white		
■ 44PJTC3BEG/3D	1	25
Beige spazzolato 3D 3D brushed beige		
■ 44PJTC3CBS/3D	1	25
Carbon scuro 3D 3D dark carbon		
■ 44PJTC3ONC/3D	1	25
Onice 3D 3D onyx		

Nota: assicurarsi che la placca sia perfettamente aderente agli apparecchi di comando "a scomparsa"

Note: make sure that the front plate sticks perfectly to the "hidden" control devices

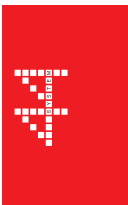

Sistema 45



# Placche Tecnopolimero

Tecnopolimero front plates



Placche "Young Touch" in tecnopolimero per scatola 4 moduli (interasse 108,5 mm)  
"Young Touch" moulded front plates for rectangular 4 modules box (fixing centres 108,5 mm)

246

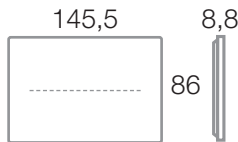

Supporto da utilizzare  
To be used with



44A04

Descrizione Description

Info

€

□

□

Fino a 4 comandi "a scomparsa"  
Up to 4 "hidden" controls

■ 44PJTC4AVR Avorio Ivory	1	20
□ 44PJTC4B Bianco White	1	20
□ 44PJTC4BT Bianco totale Total white	1	20
■ 44PJTC4CNR Cenere Ash	1	20
■ 44PJTC4GM Grigio metallizzato Metallic grey	1	20
■ 44PJTC4GOLD Oro Gold	1	20
□ 44PJTC4GSO Gesso Plaster	1	20
■ 44PJTC4GTK Grigio Tekla Tekla grey	1	20
■ 44PJTC4GTKT Grigio antracite Anthracite grey	1	20
■ 44PJTC4NAL Nero assoluto Absolute black	1	20
■ 44PJTC4SA Sabbia Sand	1	20
■ 44PJTC4SAL Salvia Sage	1	20
□ 44PJTC4B/3D Bianco 3D 3D white	1	20
■ 44PJTC4BEG/3D Beige spazzolato 3D 3D brushed beige	1	20
■ 44PJTC4CBS/3D Carbon scuro 3D 3D dark carbon	1	20
■ 44PJTC4ONC/3D Onice 3D 3D onyx	1	20

**Nota:** assicurarsi che la placca sia perfettamente aderente agli apparecchi di comando "a scomparsa"

**Note:** make sure that the front plate sticks perfectly to the "hidden" control devices



Per la disponibilità contattare la rete commerciale  
For availability please contact sales dept.



Disponibilità fino ad esaurimento scorte  
Available until stock out



Prodotto per scatola rettangolare inglese  
Product for British standard rectangular box



Prodotto per Export  
For Export only

Placche "Young Touch" in tecnopolimero per scatola 6-7 moduli (interasse 158,5 mm)  
 "Young Touch" moulded front plates for rectangular 6-7 modules box (fixing centres 158,5 mm)

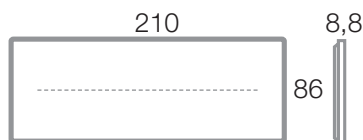
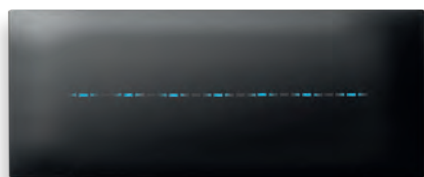

## Descrizione Description

Info

€



Fino a 7 comandi "a scomparsa"  
 Up to 7 "hidden" controls

■ 44PJTC7AVN Avana Havana	1	15
■ 44PJTC7AVR Avorio Ivory	1	15
□ 44PJTC7B Bianco White	1	15
□ 44PJTC7BT Bianco totale Total white	1	15
■ 44PJTC7CNR Cenere Ash	1	15
■ 44PJTC7GM Grigio metallizzato Metallic grey	1	15
■ 44PJTC7GOLD Oro Gold	1	15
□ 44PJTC7GSO Gesso Plaster	1	15
■ 44PJTC7GTK Grigio Tekla Tekla grey	1	15
■ 44PJTC7GKT Grigio antracite Anthracite grey	1	15
■ 44PJTC7NAL Nero assoluto Absolute black	1	15
■ 44PJTC7SA Sabbia Sand	1	15
■ 44PJTC7SAL Salvia Sage	1	15
□ 44PJTC7B/3D Bianco 3D 3D white	1	15
■ 44PJTC7BEG/3D Beige spazzolato 3D 3D brushed beige	1	15
■ 44PJTC7CBS/3D Carbon scuro 3D 3D dark carbon	1	15
■ 44PJTC7ONC/3D Onice 3D 3D onyx	1	15

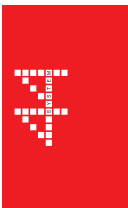

Sistema 45

Supporto da utilizzare  
 To be used with



44A07

**Nota:** assicurarsi che la placca sia perfettamente aderente agli apparecchi di comando "a scomparsa"

**Note:** make sure that the front plate sticks perfectly to the "hidden" control devices





# Placche Tecnopolimero

Tecnopolimero front plates



Placche "Young 44" in tecnopolimero per scatola tonda o quadrata  
"Young 44" moulded front plates for round or square box

248



Descrizione Description

Info

€

□

□

Per 2 comandi standard 44  
For 2 S44 standard controls

44PJ32AVN	Avana Havana		1	25
44PJ32AVR	Avorio Ivory		1	25
44PJ32B	Bianco White		1	25
44PJ32B/3D	Bianco 3D 3D white		1	25
44PJ32BEG/3D	Beige spazzolato 3D 3D brushed beige		1	25
44PJ32B0	Bianco opaco Matt white		1	25
44PJ32BT	Bianco totale Total white		1	25
44PJ32BR	Bronzo Bronze		1	15
44PJ32CBS/3D	Carbon scuro 3D 3D carbon dark		1	25
44PJ32CNR	Cenere Ash		1	25
44PJ32GM	Grigio metallizzato Metallic grey		1	25
44PJ32GO	Grigio opaco Matt grey		1	25
44PJ32GOLD	Oro Gold		1	25
44PJ32GSO	Gesso Plaster		1	25
44PJ32GTK	Grigio Tekla Tekla grey		1	25
44PJ32GTKT	Grigio antracite Anthracite grey		1	25
44PJ32NAL	Nero assoluto Absolute black		1	25
44PJ32ONG/3D	Onice 3D 3D onyx		1	25
44PJ32RA	Ottone Brass		1	25
44PJ32RD	Radica opaco Matt briarwood		1	25
44PJ32SA	Sabbia Sand		1	25
44PJ32SAL	Salvia Sage		1	25
44PJ32TO	Tortora opaco Matt dove grey		1	25

Supporto da utilizzare  
To be used with



44A02  
44A02SG  
44A02VT

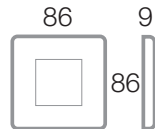

Per la disponibilità contattare  
la rete commerciale  
For availability please contact  
sales dept.



Disponibilità fino ad  
esaurimento scorte  
Available until stock out



Prodotto per scatola  
rettangolare inglese  
Product for British standard  
rectangular box



Prodotto  
per Export  
For Export  
only

Placche "Young 44" in tecnopolimero per scatola tonda o quadrata  
 "Young 44" moulded front plates for round or square box

249



Descrizione Description

Info

€

□

□

Per 4 comandi standard 44  
 For 4 S44 standard controls

44PJ34BT	Bianco totale Total white	1	1
44PJ34GM	Grigio metallizzato Metallic grey	1	1
44PJ34GOLD	Oro Gold	1	1
44PJ34GTK	Grigio Tekla Tekla grey	1	1

Soluzione Installativa Installation solution

Supporto da utilizzare  
 To be used with



44A02  
 44A02SG  
 44A02VT

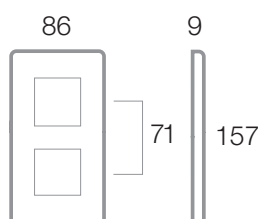

Placca  
 Front plate



Sistema 45



Descrizione Description

Info

€

□

□

Per 6 comandi standard 44  
 For 6 S44 standard controls

44PJ36BT	Bianco totale Total white	1	1
44PJ36GM	Grigio metallizzato Metallic grey	1	1
44PJ36GOLD	Oro Gold	1	1
44PJ36GTK	Grigio Tekla Tekla grey	1	1

Soluzione Installativa Installation solution

Supporto da utilizzare  
 To be used with



44A02  
 44A02SG  
 44A02VT

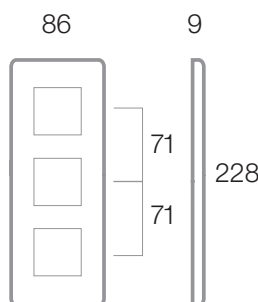

Placca  
 Front plate

Le dimensioni, salvo diversamente specificato, sono in mm  
 Dimensions, except where otherwise specified, are in mm

□ Imballo Minimo pcs  
 Min. Packaging pcs

□ Imballo Standard pcs  
 Std. Packaging pcs



# Placche Tecnopolimero

Tecnopolimero front plates



Placche "Young 44" in tecnopolimero per scatola tonda o quadrata  
"Young 44" moulded front plates for round or square box

250



Supporto da utilizzare  
To be used with



44A02  
44A02SG  
44A02VT

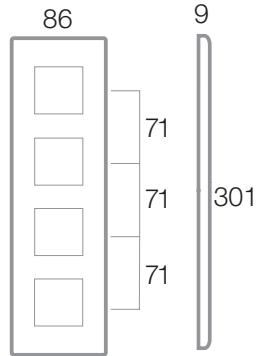

Descrizione Description

Info

€

□

□

Per 8 comandi standard 44  
For 8 S44 standard controls

44PJ38BT	Bianco totale Total white	1	1
44PJ38GM	Grigio metallizzato Metallic grey	1	1
44PJ38GOLD	Oro Gold	1	1
44PJ38GTK	Grigio Tekla Tekla grey	1	1

Placche "Young 44" in tecnopolimero per scatola 3 moduli (interasse 83,5 mm)  
"Young 44" moulded front plates for 3 modules box (fixing centres 83,5 mm)

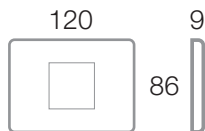
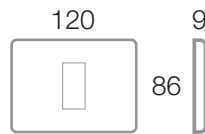

Descrizione Description

Info

€

□

□

Per 1 comando standard 44  
For 1 S44 standard control

44PJ01BT	Bianco totale Total white	1	25
----------	------------------------------	---	----

Per 2 comandi standard 44  
For 2 S44 standard controls

44PJ02BT	Bianco totale Total white	1	25
----------	------------------------------	---	----

Supporto da utilizzare  
To be used with



44A03  
44A002  
44A002VT



Per la disponibilità contattare la rete commerciale  
For availability please contact sales dept.



Disponibilità fino ad esaurimento scorte  
Available until stock out



Prodotto per scatola rettangolare inglese  
Product for British standard rectangular box



Prodotto per Export  
For Export only

Placche "Young 44" in tecnopolimero per scatola 3 moduli (interasse 83,5 mm)  
 "Young 44" moulded front plates for 3 modules box (fixing centres 83,5 mm)



Descrizione Description		Info	€	<input type="checkbox"/>	<input type="checkbox"/>
<b>Per 3 comandi standard 44</b> <i>For 3 S44 standard controls</i>					
44PJ03AVN	Avana <i>Havana</i>		1	25	
44PJ03AVR	Avorio <i>Ivory</i>		1	25	
44PJ03B	Bianco <i>White</i>		1	25	
44PJ03B/3D	Bianco 3D <i>3D white</i>		1	25	
44PJ03BEG/3D	Beige spazzolato 3D <i>3D brushed beige</i>		1	25	
44PJ03BO	Bianco opaco <i>Matt white</i>		1	25	
44PJ03BT	Bianco totale <i>Total white</i>		1	25	
44PJ03BR	Bronzo <i>Bronze</i>		1	25	
44PJ03CBS/3D	Carbon scuro 3D <i>3D carbon dark</i>		1	25	
44PJ03CNR	Cenere <i>Ash</i>		1	25	
44PJ03GM	Grigio metallizzato <i>Metallic grey</i>		1	25	
44PJ03GO	Grigio opaco <i>Matt grey</i>		1	25	
44PJ03GOLD	Oro <i>Gold</i>		1	25	
44PJ03GSO	Gesso <i>Plaster</i>		1	25	
44PJ03GTK	Grigio Tekla <i>Tekla grey</i>		1	25	
44PJ03GTKT	Grigio antracite <i>Anthracite grey</i>		1	25	
44PJ03NAL	Nero assoluto <i>Absolute black</i>		1	25	
44PJ03ONC/3D	Onice 3D <i>3D onyx</i>		1	25	
44PJ03RA	Ottone <i>Brass</i>		1	25	
44PJ03RD	Radica opaco <i>Matt briarwood</i>		1	25	
44PJ03SA	Sabbia <i>Sand</i>		1	25	
44PJ03SAL	Salvia <i>Sage</i>		1	25	
44PJ03TO	Tortora opaco <i>Matt dove grey</i>		1	25	

Supporto da utilizzare  
To be used with

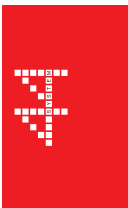
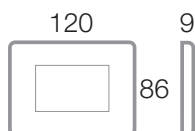



# Placche Tecnopolimero

Tecnopolimero front plates



Placche "Young 44" in tecnopolimero per scatola 4 moduli (interasse 108,5 mm)  
"Young 44" moulded front plates for 4 modules box (fixing centres 108,5 mm)

252

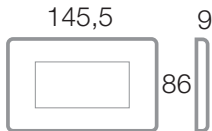

Supporto da utilizzare  
To be used with



Descrizione	Description	Info	€	□	□
44PJ04AVN	Avana Havana		1	20	
44PJ04AVR	Avorio Ivory		1	20	
44PJ04B	Bianco White		1	20	
44PJ04B/3D	Bianco 3D 3D white		1	20	
44PJ04BEG/3D	Beige spazzolato 3D 3D brushed beige		1	20	
44PJ04BO	Bianco opaco Matt white		1	20	
44PJ04BT	Bianco totale Total white		1	20	
44PJ04BR	Bronzo Bronze		1	20	
44PJ04CBS/3D	Carbon scuro 3D 3D carbon dark		1	20	
44PJ04CNR	Cenere Ash		1	20	
44PJ04GM	Grigio metallizzato Metallic grey		1	20	
44PJ04GO	Grigio opaco Matt grey		1	20	
44PJ04GOLD	Oro Gold		1	20	
44PJ04GSO	Gesso Plaster		1	20	
44PJ04GTK	Grigio Tekla Tekla grey		1	20	
44PJ04GTKT	Grigio antracite Anthracite grey		1	20	
44PJ04NAL	Nero assoluto Absolute black		1	20	
44PJ04ONC/3D	Onice 3D 3D onyx		1	20	
44PJ04RA	Ottone Brass		1	20	
44PJ04RD	Radica opaco Matt briarwood		1	20	
44PJ04SA	Sabbia Sand		1	20	
44PJ04SAL	Salvia Sage		1	20	
44PJ04TO	Tortora opaco Matt dove grey		1	20	



Per la disponibilità contattare la rete commerciale  
For availability please contact sales dept.



Disponibilità fino ad esaurimento scorte  
Available until stock out



Prodotto per scatola rettangolare inglese  
Product for British standard rectangular box



Prodotto per Export  
For Export only

Placche "Young 44" in tecnopolimero per scatola 7 moduli (interasse 158,5 mm)  
 "Young 44" moulded front plates for 7 modules box (fixing centres 158,5 mm)

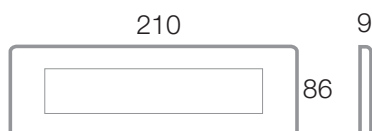

Supporto da utilizzare  
 To be used with



Descrizione Description		Info	€	<input type="checkbox"/>	<input type="checkbox"/>
44PJ07AVN	Avana Havana		1	15	
44PJ07AVR	Avorio Ivory		1	15	
44PJ07B	Bianco White		1	15	
44PJ07B/3D	Bianco 3D 3D white		1	15	
44PJ07BEG/3D	Beige spazzolato 3D 3D brushed beige		1	15	
44PJ07BO	Bianco opaco Matt white		1	15	
44PJ07BT	Bianco totale Total white		1	15	
44PJ07BR	Bronzo Bronze		1	15	
44PJ07CBS/3D	Carbon scuro 3D 3D carbon dark		1	15	
44PJ07CNR	Cenere Ash		1	15	
44PJ07GM	Grigio metallizzato Metallic grey		1	15	
44PJ07GO	Grigio opaco Matt grey		1	15	
44PJ07GOLD	Oro Gold		1	15	
44PJ07GSO	Gesso Plaster		1	15	
44PJ07GTK	Grigio Tekla Tekla grey		1	15	
44PJ07GTKT	Grigio antracite Anthracite grey		1	15	
44PJ07NAL	Nero assoluto Absolute black		1	15	
44PJ07ONC/3D	Onice 3D 3D onyx		1	15	
44PJ07RA	Ottone Brass		1	15	
44PJ07RD	Radica opaco Matt briarwood		1	15	
44PJ07SA	Sabbia Sand		1	15	
44PJ07SAL	Salvia Sage		1	15	
44PJ07TO	Tortora opaco Matt dove grey		1	15	

253

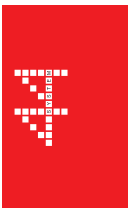

Sistema 45

# Placche

## Front Plates

Design:  
L. Merletti

254

I colori delle placche "Tecnopolimero 44" per scatola rettangolare  
"Moulded 44" front plates colours for rectangular box



**44PY03B**  
Bianco RAL 9010  
*RAL 9010 white*



**44PY03BLC**  
Bianco RAL 9010  
cornice cromata  
*RAL 9010 white  
chrome inner frame*



**44PY03M**  
Marmo  
*Marble*



**44PY03SA**  
Sabbia RAL 1013  
*RAL 1013 sand*



**44PY03CHO**  
Champagne opaco  
*Matt champagne*



**44PY03OT**  
Ottone lucido  
*Polished brass*



**44PY03RD**  
Radica opaca  
*Matt briarwood*



**44PY03GSL**  
Grigio scuro lucido  
*Polished dark grey*



**44PY03GSM**  
Grigio scuro metallizzato  
*Metallic dark grey*



**44PY03GTK**  
Grigio Tekla  
*Tekla grey*



**44PY03ALS**  
Alluminio naturale  
cornice cromata  
*Natural aluminium  
chrome inner frame*



**44PY03AO**  
Argento opaco  
*Matt silver*



**44PY03GTKC**  
Grigio Tekla  
cornice cromata  
*Tekla grey  
chrome inner frame*



**44PY03NAL**  
Nero assoluto  
cornice cromata  
*Absolute black  
chrome inner frame*





# Placche Tecnopolimero

Tecnopolimero front plates



Placche "Tecnopolimero 44" in tecnopolimero 80x80 mm per scatola tonda o quadrata  
"Moulded 44" moulded 80x80 mm front plates for square or round box

256

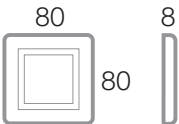
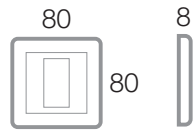

Supporto da utilizzare  
To be used with



44A02  
44A02SG  
44A02VT

Descrizione Description

Info

€

□

□

Per 1 comando standard 44  
For 1 S44 standard control

44P31B	Bianco Ral 9010 Ral 9010 white	1	30
44P31GSL	Grigio scuro lucido Polished dark grey	1	30
44P31GSM	Grigio scuro metallizzato Metallic dark grey	1	30
44P31SA	Sabbia Ral 1013 Ral 1013 sand	1	30

Descrizione Description

Info

€

□

□

Per 2 comandi standard 44  
For 2 S44 standard controls

44P32ALS	Alluminio naturale - cornice cromata Natural aluminium - chrome inner frame	1	30
44P32AO	Argento opaco Matt silver	1	30
44P32B	Bianco Ral 9010 Ral 9010 white	1	30
44P32BLC	Bianco Ral 9010 - cornice cromata Ral 9010 white - chrome inner frame	1	30
44P32GSL	Grigio scuro lucido Polished dark grey	1	30
44P32GSM	Grigio scuro metallizzato Metallic dark grey	1	30
44P32GTK	Grigio Tekla Tekla grey	1	30
44P32NAL	Nero assoluto - cornice cromata Absolute black - chrome inner frame	1	30
44P32SA	Sabbia Ral 1013 Ral 1013 sand	1	30



Per la disponibilità contattare la rete commerciale  
For availability please contact sales dept.



Disponibilità fino ad esaurimento scorte  
Available until stock out



Prodotto per scatola rettangolare inglese  
Product for British standard rectangular box



Prodotto per Export  
For Export only

**Placche "Tecnopolimero 44" in tecnopolimero per scatola tonda o quadrata**  
**"Moulded 44" moulded front plates for square or round box**

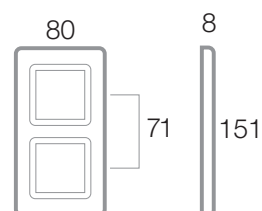

**Supporto da utilizzare**  
**To be used with**



n° 2 44A02  
 n° 2 44A02SG  
 n° 2 44A02VT

**Descrizione Description**

**Info**

€

□

□

257

**Per 4 comandi standard 44**  
**For 4 S44 standard controls**

<b>44P34ALS</b>	Alluminio naturale - cornice cromata <i>Natural aluminium - chrome inner frame</i>	1	15
<b>44P34A0</b>	Argento opaco <i>Matt silver</i>	1	15
<b>44P34B</b>	Bianco Ral 9010 <i>Ral 9010 white</i>	1	15
<b>44P34BLC</b>	Bianco Ral 9010 - cornice cromata <i>Ral 9010 white - chrome inner frame</i>	1	15
<b>44P34GSL</b>	Grigio scuro lucido <i>Polished dark grey</i>	1	15
<b>44P34GSM</b>	Grigio scuro metallizzato <i>Metallic dark grey</i>	1	15
<b>44P34GTK</b>	Grigio Tekla <i>Tekla grey</i>	1	15
<b>44P34GTKC</b>	Grigio Tekla - cornice cromata <i>Tekla grey - chrome inner frame</i>	1	15
<b>44P34NAL</b>	Nero assoluto - cornice cromata <i>Absolute black - chrome inner frame</i>	1	15
<b>44P34SA</b>	Sabbia Ral 1013 <i>Ral 1013 sand</i>	1	15

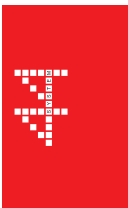

Sistema 45

**Soluzione Installativa Installation solution**

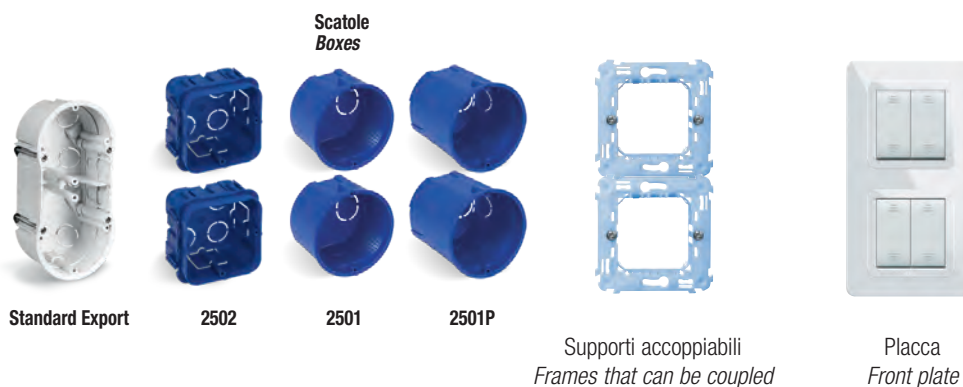

Le dimensioni, salvo diversamente specificato, sono in mm  
 Dimensions, except where otherwise specified, are in mm

□ Imballo Minimo pcs  
 Min. Packaging pcs

□ Imballo Standard pcs  
 Std. Packaging pcs



# Placche Tecnopolimero

Tecnopolimero front plates



Placche "Tecnopolimero 44" in tecnopolimero per scatola tonda o quadrata  
"44 moulded" moulded front plates for square or round box

258

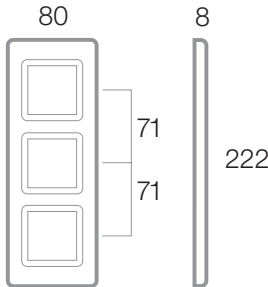

Descrizione Description

Info

€

□

□

Per 6 comandi standard 44  
For 6 S44 standard controls

44P36ALS	Alluminio naturale - cornice cromata Natural aluminium - chrome inner frame	1	10
44P36AO	Argento opaco Matt silver	1	10
44P36B	Bianco Ral 9010 Ral 9010 white	1	10
44P36BLC	Bianco Ral 9010 - cornice cromata Ral 9010 white - chrome inner frame	1	10
44P36GSL	Grigio scuro lucido Polished dark grey	1	10
44P36GSM	Grigio scuro metallizzato Metallic dark grey	1	10
44P36GTK	Grigio Tekla Tekla grey	1	10
44P36GTKC	Grigio Tekla - cornice cromata Tekla grey - chrome inner frame	1	10
44P36NAL	Nero assoluto - cornice cromata Absolute black - chrome inner frame	1	10
44P36SA	Sabbia Ral 1013 Ral 1013 sand	1	10

Supporto da utilizzare  
To be used with



n° 3 44A02  
n° 3 44A02SG  
n° 3 44A02VT

## Soluzione Installativa Installation solution

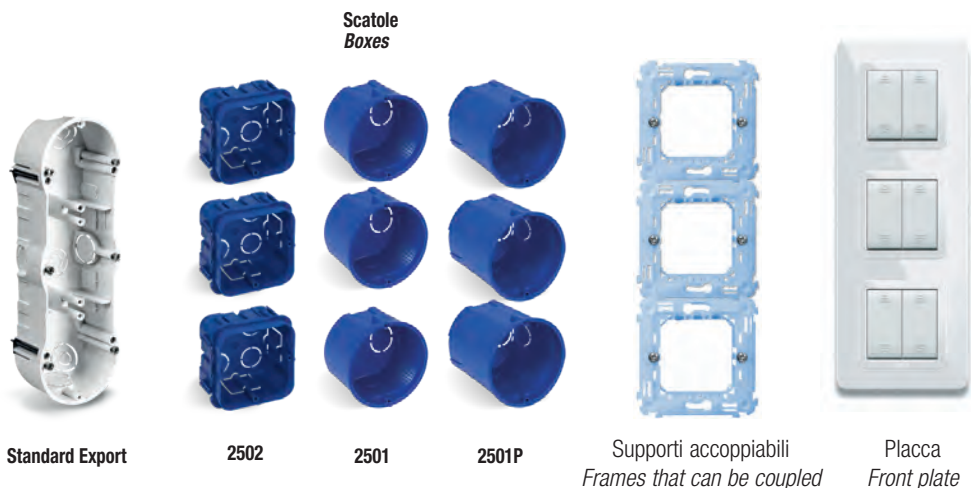

Per la disponibilità contattare la rete commerciale  
For availability please contact sales dept.



Disponibilità fino ad esaurimento scorte  
Available until stock out



Prodotto per scatola rettangolare inglese  
Product for British standard rectangular box



Prodotto per Export  
For Export only

Placche "Tecnopolimero 44" in tecnopolimero 88x88 mm per scatola tonda o quadrata  
 "44 moulded" moulded 88x88 mm front plates for square or round box

259

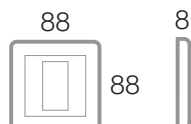

Descrizione Description

Info

€



Per 1 comando standard 44  
 For 1 S44 standard control

44PY31A0	Argento opaco Matt silver	1	30
44PY31B	Bianco Ral 9010 Ral 9010 white	1	30
44PY31GSL	Grigio scuro lucido Polished dark grey	1	30
44PY31GSM	Grigio scuro metallizzato Metallic dark grey	1	30
44PY31SA	Sabbia Ral 1013 Ral 1013 sand	1	30

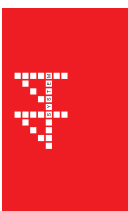

Sistema 45

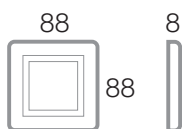

Descrizione Description

Info

€



Per 2 comandi standard 44  
 For 2 S44 standard controls

44PY32A0	Argento opaco Matt silver	1	30
44PY32B	Bianco Ral 9010 Ral 9010 white	1	30
44PY32GSL	Grigio scuro lucido Polished dark grey	1	30
44PY32GSM	Grigio scuro metallizzato Metallic dark grey	1	30
44PY32SA	Sabbia Ral 1013 Ral 1013 sand	1	30

Supporto da utilizzare  
 To be used with



44A02  
 44A02SG  
 44A02VT



# Placche Tecnopolimero

Tecnopolimero front plates



Placche "Tecnopolimero 44" in tecnopolimero per scatola 3 moduli (interasse 83,5 mm)  
"44 moulded" moulded front plates for 3 modules box (fixing centres 83,5 mm)

260

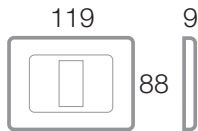

## Descrizione Description

Info

€

□

□

Per 1 comando standard 44

For 1 S44 standard control

44PY01A0	Argento opaco Matt silver	1	25
44PY01B	Bianco Ral 9010 Ral 9010 white	1	25
44PY01GSL	Grigio scuro lucido Polished dark grey	1	25
44PY01SA	Sabbia Ral 1013 Ral 1013 sand	1	25

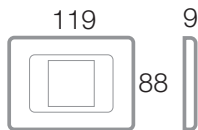

## Descrizione Description

Info

€

□

□

Per 2 comandi standard 44

For 2 S44 standard controls

44PY02A0	Argento opaco Matt silver	1	25
44PY02B	Bianco Ral 9010 Ral 9010 white	1	25
44PY02GSL	Grigio scuro lucido Polished dark grey	1	25
44PY02SA	Sabbia Ral 1013 Ral 1013 sand	1	25

Supporto da utilizzare  
To be used with



44A03



Per la disponibilità contattare la rete commerciale  
For availability please contact sales dept.



Disponibilità fino ad esaurimento scorte  
Available until stock out



Prodotto per scatola rettangolare inglese  
Product for British standard rectangular box



Prodotto per Export  
For Export only

**Placche "Tecnopolimero 44" in tecnopolimero per scatola 3 moduli (interasse 83,5 mm**  
**"44 moulded" moulded front plates for 3 modules box (fixing centres 83,5 mm)**

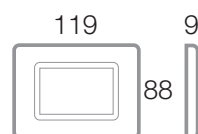

Supporto da utilizzare  
To be used with



44A03

Descrizione Description		Info	€	<input type="checkbox"/>	<input type="checkbox"/>
<b>Per 3 comandi standard 44</b> <i>For 3 S44 standard controls</i>					
44PY03ALS	Alluminio naturale - cornice cromata <i>Natural aluminium - chrome inner frame</i>	1	25		
44PY03AO	Argento opaco <i>Matt silver</i>	1	25		
44PY03B	Bianco Ral 9010 <i>Ral 9010 white</i>	1	25		
44PY03BLC	Bianco Ral 9010 - cornice cromata <i>Ral 9010 white - chrome inner frame</i>	1	25		
44PY03CHO	Champagne opaco <i>Matt champagne</i>	1	25		
44PY03GSL	Grigio scuro lucido <i>Polished dark grey</i>	1	25		
44PY03GSM	Grigio scuro metallizzato <i>Metallic dark grey</i>	1	25		
44PY03GTK	Grigio Tekla <i>Tekla grey</i>	1	25		
44PY03GTKC	Grigio Tekla - cornice cromata <i>Tekla grey - chrome inner frame</i>	1	25		
44PY03M	Marmo <i>Marble</i>	1	25		
44PY03NAL	Nero assoluto - cornice cromata <i>Absolute black - chrome inner frame</i>	1	25		
44PY03OT	Ottone lucido <i>Polished brass</i>	1	25		
44PY03RD	Radica opaca <i>Matt briarwood</i>	1	25		
44PY03SA	Sabbia Ral 1013 <i>Ral 1013 sand</i>	1	25		



Sistema 45



# Placche Tecnopolimero

Tecnopolimero front plates



Placche "Tecnopolimero 44" in tecnopolimero per scatola 4 moduli (interasse 108,5 mm)  
"44 moulded" moulded front plates for 4 modules box (fixing centres 108,5 mm)

262

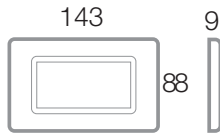

Supporto da utilizzare  
To be used with



Descrizione Description Info € □ □

### Per 4 comandi standard 44

For 4 S44 standard controls

44PY04ALS	Alluminio naturale - cornice cromata Natural aluminium - chrome inner frame	1	20
44PY04AO	Argento opaco Matt silver	1	20
44PY04B	Bianco Ral 9010 Ral 9010 white	1	20
44PY04BLC	Bianco Ral 9010 - cornice cromata Ral 9010 white - chrome inner frame	1	20
44PY04CHO	Champagne opaco Matt champagne	1	20
44PY04GSL	Grigio scuro lucido Polished dark grey	1	20
44PY04GSM	Grigio scuro metallizzato Metallic dark grey	1	20
44PY04GTK	Grigio Tekla Tekla grey	1	20
44PY04GTKC	Grigio Tekla - cornice cromata Tekla grey - chrome inner frame	1	20
44PY04M	Marmo Marble	1	20
44PY04NAL	Nero assoluto - cornice cromata Absolute black - chrome inner frame	1	20
44PY04OT	Ottone lucido Polished brass	1	20
44PY04RD	Radica opaca Matt briarwood	1	20
44PY04SA	Sabbia Ral 1013 Ral 1013 sand	1	20



Per la disponibilità contattare  
la rete commerciale  
For availability please contact  
sales dept.



Disponibilità fino ad  
esaurimento scorte  
Available until stock out



Prodotto per scatola  
rettangolare inglese  
Product for British standard  
rectangular box



Prodotto  
per Export  
For Export  
only

**Placche "Tecnopolimero 44" in tecnopolimero per scatola 7 moduli (interasse 158,5 mm)**  
**"44 moulded" moulded front plates for 7 modules box (fixing centres 158,5 mm)**



Supporto da utilizzare  
To be used with



44A07

Descrizione <i>Description</i>		Info	€	□	□
<b>Per 7 comandi standard 44</b> <b>For 7 S44 standard controls</b>					
44PY07ALS	Alluminio naturale - cornice cromata <i>Natural aluminium - chrome inner frame</i>	1	15		
44PY07AO	Argento opaco <i>Matt silver</i>	1	15		
44PY07B	Bianco Ral 9010 <i>Ral 9010 white</i>	1	15		
44PY07BLC	Bianco Ral 9010 - cornice cromata <i>Ral 9010 white - chrome inner frame</i>	1	15		
44PY07CHO	Champagne opaco <i>Matt champagne</i>	1	15		
44PY07GSL	Grigio scuro lucido <i>Polished dark grey</i>	1	15		
44PY07GSM	Grigio scuro metallizzato <i>Metallic dark grey</i>	1	15		
44PY07GTK	Grigio Tekla <i>Tekla grey</i>	1	15		
44PY07GTKC	Grigio Tekla - cornice cromata <i>Tekla grey - chrome inner frame</i>	1	15		
44PY07M	Marmo <i>Marble</i>	1	15		
44PY07NAL	Nero assoluto - cornice cromata <i>Absolute black - chrome inner frame</i>	1	15		
44PY07OT	Ottone lucido <i>Polished brass</i>	1	15		
44PY07RD	Radica opaca <i>Matt briarwood</i>	1	15		
44PY07SA	Sabbia Ral 1013 <i>Ral 1013 sand</i>	1	15		

263

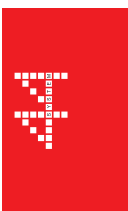

Sistema 45





# Placche Tecnopolimero

Tecnopolimero front plates



Placche "Tecnopolimero 44" in tecnopolimero per scatola BL02..  
"44 moulded" moulded front plates for BL02.. box

264



Descrizione Description Info € □ ▢

Per 6(3+3) comandi standard 44  
For 6(3+3) S44 standard controls

44PY033A0	Argento opaco Matt silver	1	5
44PY033B	Bianco Ral 9010 Ral 9010 white	1	5
44PY033GSL	Grigio scuro lucido Polished dark grey	1	5
44PY033SA	Sabbia Ral 1013 Ral 1013 sand	1	5

Supporto da utilizzare  
To be used with



44A33

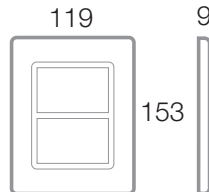

Scatola da utilizzare  
To be used with



BL02P  
Pareti in muratura  
Brickwork walls



BL02CG  
Pareti in cartongesso  
Hollow walls

Placche "Tecnopolimero 44" in tecnopolimero per scatola BL05..  
"44 moulded" moulded front plates for BL05.. box



Descrizione Description Info € □ ▢

Per 12(6+6) comandi standard 44  
For 12(6+6) S44 standard controls

44PY012A0	Argento opaco Matt silver	1	5
44PY012B	Bianco Ral 9010 Ral 9010 white	1	5
44PY012GSL	Grigio scuro lucido Polished dark grey	1	5

Supporto da utilizzare  
To be used with



44A12

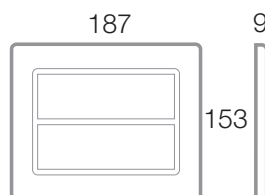

Scatola da utilizzare  
To be used with



BL05P  
Pareti in muratura  
Brickwork walls

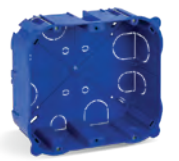

BL05CG  
Pareti in cartongesso  
Hollow walls



Per la disponibilità contattare  
la rete commerciale  
For availability please contact  
sales dept.



Disponibilità fino ad  
esaurimento scorte  
Available until stock out



Prodotto per scatola  
rettangolare inglese  
Product for British standard  
rectangular box



Prodotto  
per Export  
For Export  
only

**Placche "Tecnopolimero 44" in tecnopolimero per pannelli/profilati**  
 "44 moulded" moulded front plates for section bars

Descrizione Description		Info	€	<input type="checkbox"/>	<input type="checkbox"/>	265
						
<b>Per 1 comando standard 44</b>						
<i>For 1 S44 standard control</i>						
<b>44PF1B</b>	Bianco Ral 9010 <i>Ral 9010 white</i>	1	50			
<b>44PF1GSL</b>	Grigio scuro lucido <i>Polished dark grey</i>	1	50			



**Supporto da utilizzare**  
*To be used with*



44A01

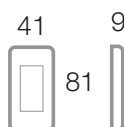

Descrizione Description		Info	€	<input type="checkbox"/>	<input type="checkbox"/>
					
<b>Per 2(1+1) comandi standard 44</b>					
<i>For 2(1+1) S44 standard controls</i>					
<b>44PF2B</b>	Bianco Ral 9010 <i>Ral 9010 white</i>	1	30		

**Supporto da utilizzare**  
*To be used with*



44A01

+

44A01

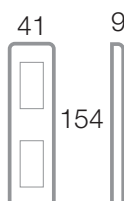

# Placche

## Front Plates

BREVETTO AVE N° 209  
AVE PATENT N° 209

Design:  
L. Merletti

266

I colori delle placche "Personal 44" per scatola rettangolare  
"Personal 44" front plates colours for rectangular box

Plastica *Plastic*



**44P03B**  
Bianco lucido RAL 9010  
*RAL 9010 polished white*



**44P03ALS**  
Alluminio naturale  
*Natural aluminium*



**44P03GRL**  
Grigio scuro lucido  
*Polished dark grey*



**44P03NAL**  
Nero assoluto lucido  
*Polished absolute black*



**44P03BEL**  
Beige lucido  
*Polished beige*



**44P03TR**  
Placca trasparente personalizzabile (da assemblare)  
*Transparent customizable front plate (to assemble)*

Sottoplacca *Plate support*

Cover trasparente *Transparent cover*

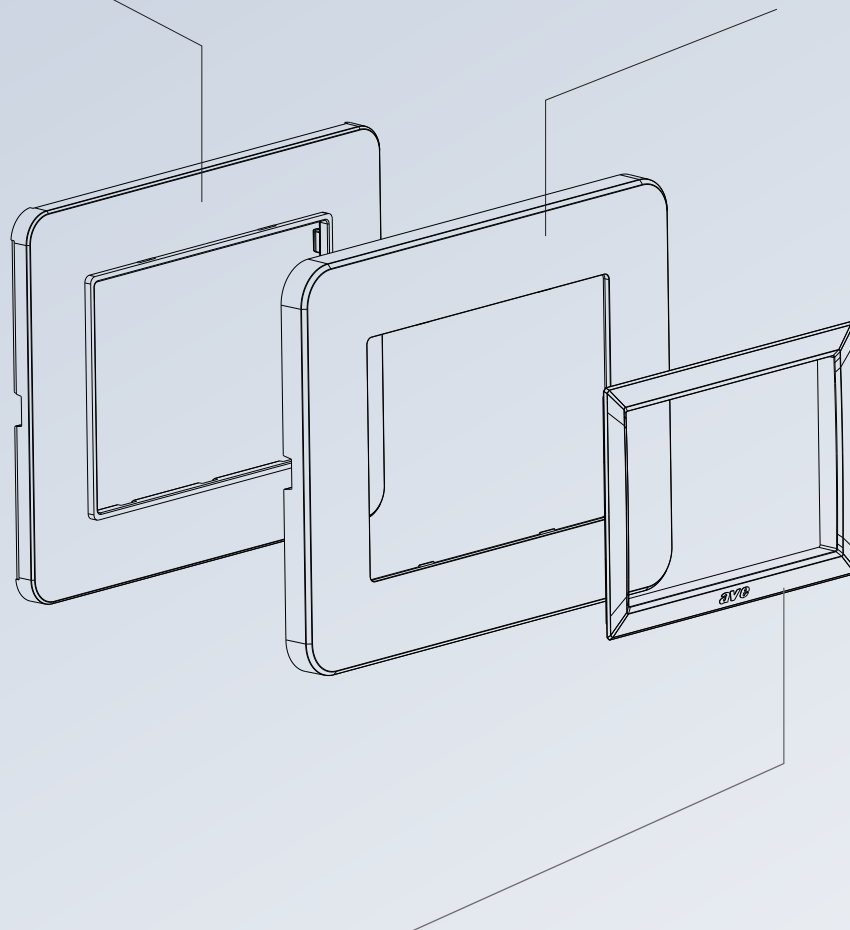

Cornicette di ricambio *Spare inner frames*

	Cod. Code	Colore Colour	Info	€	□	□
	44CR3N	Grigio scuro lucido <i>Polished dark grey</i>		2	50	
	44CR3CR	Cromo <i>Chrome</i>		2	50	
	44CR4N	Grigio scuro lucido <i>Polished dark grey</i>		2	50	
	44CR4CR	Cromo <i>Chrome</i>		2	50	
	44CR7N	Grigio scuro lucido <i>Polished dark grey</i>		2	30	
	44CR7CR	Cromo <i>Chrome</i>		2	30	



# Placche Tecnopolimero

Tecnopolimero front plates



Placche "Personal 44" in tecnopolimero per scatola 3 moduli (interasse 83,5 mm)  
"44 Personal" moulded front plates for 3 modules box (fixing centres 83,5 mm)

268



Cod. Code	Colore Colour	Cornicetta Inner frame	Info	€	□	□
-----------	---------------	------------------------	------	---	---	---

Per 3 comandi standard 44  
For 3 S44 standard controls

44P03ALS	Alluminio naturale Natural aluminium	Cromo Chrome	1	12		
44P03B	Bianco lucido Ral 9010 Ral 9010 polished white	Bianco Ral 9010 Ral 9010 white	1	12		
44P03BEL	Beige lucido Polished beige	Bianco Ral 9010 Ral 9010 white	1	12		
44P03GRL	Grigio scuro lucido Polished dark grey	Bianco Ral 9010 Ral 9010 white	1	12		
44P03NAL	Nero assoluto Absolute black	Cromo Chrome	1	12		
44P03TR	Trasparente personalizzabile - fornita da assemblare (vedi fig. sotto) Transparent customizable - to be assembled (see below)	Bianco Ral 9010 (in dotazione) Grigio scuro lucido (in dotazione) Ral 9010 white (included) Polished dark grey (included)	1	12		

- Note:**
- ✓ 44P03TR diversamente dalla 44P03B viene fornita da assemblare in modo da poter essere personalizzata a cura dell'utente. Infatti oltre a prevedere la doppia cornice (bianco RAL9010 e grigio scuro lucido) viene corredata di una dima di taglio per carta da parati o tappezzeria (vedi figura sotto)
  - ✓ 44P03B stessa colorazione della 44P03TR
  - ✓ 44P03TR differently from 44P03B, has to be assembled in order to allow the customer to personalize it. Two inner frames (RAL9010 and polished dark grey), and the cutout template for wallpaper are included (see below)
  - ✓ 44P03B has the same colour as 44P03TR

Supporto da utilizzare  
To be used with



Scatole utilizzabili  
Available boxes



Pareti in muratura  
Brickwork walls



Pareti in cartongesso  
Hollow walls

Placche "Personal 44" in tecnopolimero per scatola 4 moduli (interasse 108,5 mm)  
"44 personal" moulded front plates for 4 modules box (fixing centres 108,5 mm)

Cod. Code	Colore Colour	Cornicetta Inner frame	Info	€	□	□
-----------	---------------	------------------------	------	---	---	---



Per 4 comandi standard 44  
For 4 S44 standard controls

44P04ALS	Alluminio naturale Natural aluminium	Cromo Chrome	1	10		
44P04B	Bianco lucido Ral 9010 Ral 9010 polished white	Bianco Ral 9010 Ral 9010 white	1	10		
44P04BEL	Beige lucido Polished beige	Bianco Ral 9010 Ral 9010 white	1	10		
44P04GRL	Grigio scuro lucido Polished dark grey	Bianco Ral 9010 Ral 9010 white	1	10		
44P04NAL	Nero assoluto Absolute black	Cromo Chrome	1	10		

Supporto da utilizzare  
To be used with



Scatole utilizzabili  
Available boxes



Pareti in muratura  
Brickwork walls



Pareti in cartongesso  
Hollow walls



Per la disponibilità contattare la rete commerciale  
For availability please contact sales dept.



Disponibilità fino ad esaurimento scorte  
Available until stock out



Prodotto per scatola rettangolare inglese  
Product for British standard rectangular box



Prodotto per Export  
For Export only

Placche "Personal 44" in tecnopolimero per scatola 7 moduli (interasse 158,5 mm)  
 "44 personal" moulded front plates for 7 modules box (fixing centres 158,5 mm)

Cod. Code	Colore Colour	Cornicetta Inner frame	Info	€	□	□
<b>Per 7 comandi standard 44</b> For 7 S44 standard controls						
44P07ALS	Alluminio naturale Natural aluminium	Cromo Chrome	1	5		
44P07B	Bianco lucido Ral 9010 Ral 9010 polished white	Bianco Ral 9010 Ral 9010 white	1	5		
44P07BEL	Beige lucido Polished beige	Bianco Ral 9010 Ral 9010 white	1	5		
44P07GRL	Grigio scuro lucido Polished dark grey	Bianco Ral 9010 Ral 9010 white	1	5		
44P07NAL	Nero assoluto Absolute black	Cromo Chrome	1	5		



269



Sistema 45

Supporto da utilizzare  
To be used with



44A07

Scatole utilizzabili  
Available boxes



2506

Pareti in muratura Brickwork walls



256CG

Pareti in cartongesso Hollow walls

Placche "Personal 44" in tecnopolimero per scatola BL02..  
 "44 Personal" moulded front plates for BL02.. box

Cod. Code	Colore Colour	Cornicetta Inner frame	Info	€	□	□
<b>Per 6(3+3) comandi standard 44</b> For 6(3+3) S44 standard controls						
44P033ALS	Alluminio naturale Natural aluminium	Cromo Chrome	1	5		
44P033B	Bianco lucido Ral 9010 Ral 9010 polished white	Bianco Ral 9010 Ral 9010 white	1	5		
44P033BEL	Beige lucido Polished beige	Bianco Ral 9010 Ral 9010 white	1	5		
44P033GRL	Grigio scuro lucido Polished dark grey	Bianco Ral 9010 Ral 9010 white	1	5		
44P033NAL	Nero assoluto Absolute black	Cromo Chrome	1	5		

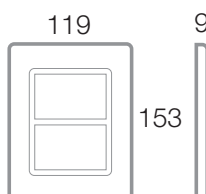

Supporto da utilizzare  
To be used with



44A33

Scatola da utilizzare  
To be used with



BL02P

Pareti in muratura  
Brickwork walls



BL02CG

Pareti in cartongesso  
Hollow walls

Le dimensioni, salvo diversamente specificato, sono in mm  
Dimensions, except where otherwise specified, are in mm

□ Imballo Minimo pcs  
Min. Packaging pcs

□ Imballo Standard pcs  
Std. Packaging pcs

# Personalizzazione Sistema 44

## System 44 Customization



## Indice Index

---

Configuratore  
Configurator

**272**

---

Placche Ave Touch personalizzabili  
Front plates Ave Touch customizable

**276**

---

Placche Multimodulo  
Multi-module front plates

**280**

---



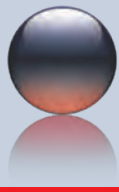

## **Nuovo sistema di personalizzazione delle placche** *New customization system of front plates*

**visita il sito**  
*visit the website*  
<https://avexclusive.ave.it>



**Caratteristiche Tecniche** *Technical Features*

### **Il personalizzatore delle placche ti permette:**

- **scelta dei materiali**
- **tipologia e dimensioni**
- **scelta dei colori**
- **caricare le tue immagini personalizzate**
- **un carrello sempre a disposizione**
- **invio della richiesta per e-mail**
- **stampa digitale, incisione laser**
- **..... e molto altro ancora**

### **The customization system allows:**

- **Material selection**
- **Type and dimensions selection**
- **Colours choice**
- **Loading of customizable images**
- **Your basket always available**
- **Sending the request by email**
- **digital print, laser engraving**
- **.... and much more**

### **Tecniche di personalizzazione** *Customization techniques*

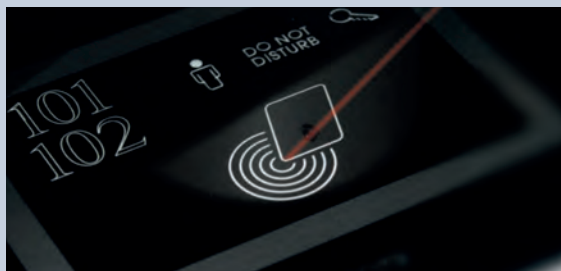

Personalizzazione su placca in vetro tramite LASER  
*Customization on glass front plate by laser*



Personalizzazione tramite stampa Digitale  
*Customization by digital print*

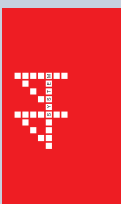

In pochi passaggi personalizza la tua placca...  
*In just a few steps, customize your front plate...*

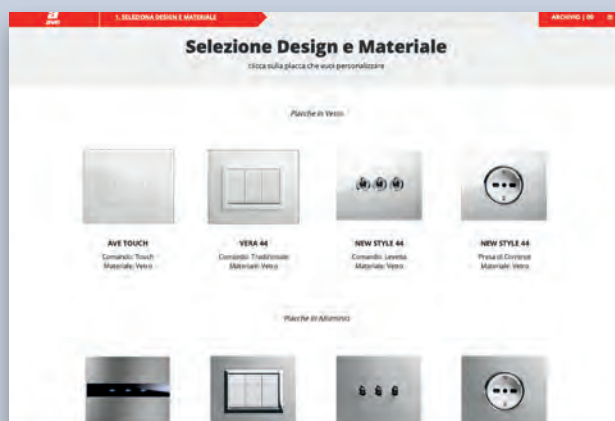

...scegli il design e materiale desiderato...  
*...choose the desired design and material ...*



...seleziona il tuo modello di placca...  
*... select your front plate model ...*



...trascina il tuo logo e vedi subito l'anteprima della tua personalizzazione...  
*... drag your logo and immediately see the preview of your customization...*

**SALVA, la personalizzazione viene salvata nel tuo archivio personale e non inviata nel backoffice. Per l'invio utilizza il tasto INVIA RICHIESTA.**

**SAVE the personalization it is saved in your personal archive and not sent to the back office. To send click on the SEND INQUIRY button.**

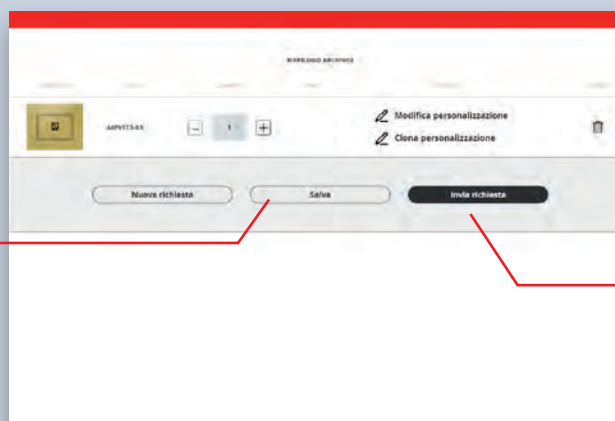

**INVIA RICHIESTA, la tua personalizzazione viene inviata nel backoffice quindi in lavorazione.**

**SEND INQUIRY, your customization is sent to the back office and it is then being processed.**

... non ti resta che **CONFERMARE** per mandare in lavorazione la tua placca personalizzata.  
*... you just have to CONFIRM to process your customized front plate order.*

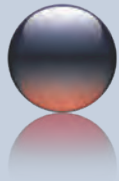

# Configuratore placche personalizzate

## Customizable front plates configurator



### Simbologie disponibili

#### Available symbols

274

Caratteristiche Tecniche Technical Features

1	2	3	4	5	6	7	8	9	10	11	12
13	14	15	16	17	18	19	20	21	22	23	24
25	26	27	28	29	30	31	32	33	34	35	36
37	38	39	40	41	42	43	44	45	46	47	48
49	50	51	52	53	54	55	56	57	58	59	60
61	62	63	63	65	66	67	68	69	70	71	72
73	74	75	76	77	78	79	80	81	82	83	84
85	86	87	88	89	90	91	92	93	94	95	96
97	98	99	100	101	102	103	104	105	106	107	108
109	110	111	112	113	114	115	116	117	118	119	120

### Font per numeri stanza placche alberghiero

#### Font for hotel front plates room numbers

Subway Ticker Regular

1	2	3	4	5	6	7	8	9	0
---	---	---	---	---	---	---	---	---	---

Times New Roman Regular

1	2	3	4	5	6	7	8	9	0
---	---	---	---	---	---	---	---	---	---

# Prezzi personalizzazione

## Customization prices



### Configuratore placche personalizzate

#### Customizable front plates configurator

Ave offre la possibilità tramite configuratore disponibile sul sito [www.ave.it](http://www.ave.it) di personalizzare la gamma di placche. I prezzi della personalizzazione riportati nelle tabelle, sono da dividere per il numero di placche aventi la stessa personalizzazione e aventi gli stessi moduli. In caso di variazione dei moduli della placca, colore o tipologia, dovrà essere ricalcolato il prezzo da ripartire sulla nuova tipologia di placca. Tale prezzo di personalizzazione sarà da aggiungere al prezzo della placca standard scelta. Disponibili nelle pagine successive le placche in vetro completamente personalizzabili, senza cornicetta e comando standard ■■■ con codice finale /XX. In caso di personalizzazione con entrambe le tipologie, loghi e simboli, andranno sommati i prezzi di entrambe le tabelle, sempre da distribuire sul numero di pezzi. Per la fattibilità, tempi e costi di tutte le altre personalizzazioni non presenti nel nuovo configuratore, ad esempio colore speciale della placca, contattare la rete commerciale Ave.

*Ave offers the possibility to customize the range of front plates through the configurator available on the website [www.ave.it](http://www.ave.it). The prices of the customization shown in the tables are to be divided by the number of front plates having the same customization and having the same modules. In case of change in the modules, the colour or the type of the front plate, the price to be divided on the new type of front plate must be recalculated. This customization price will be added to the price of the chosen standard front plate. In the following pages the completely customizable glass plates without inner frame and standard control ■■■ are available with final code /XX. In case of customization with both types, logos and symbols, the prices of both tables will be added together, always to be distributed over the number of pieces. For the feasibility, times and prices of all other customizations not present in the new configurator, for example special front plate colour, contact the AVE sales network.*



Sistema 45

#### Tablelle prezzi

I prezzi indicati fanno riferimento all'utilizzo dei font "numeri e simboli" presenti nella libreria, da distribuire sul numero di pezzi:

*Price tables*  
The prices indicated refer to the use of the "numbers and symbols" fonts present in the library, to be distributed over the number of pieces:

#### Loghi / immagini, caricati da distribuire sul numero di pezzi:

*Loaded logos / images, to be distributed over the number of pieces*

Per singola personalizzazione <i>Single customization</i>	prezzo netto 250 € <i>Net price € 250</i>
--	--

Quantità <i>Quantity</i>	Prezzi <i>Price</i>
Fino a 20 pezzi <i>Until 20 pcs</i>	Netto 18€ <i>Net 18€</i>
Da 21 pz. a 50 pezzi <i>From 21 pcs to 50 pcs</i>	Netto 12€ <i>Net 12€</i>
Da 51 pz. a 100 pezzi <i>From 51 pcs to 100 pcs</i>	Netto 7€ <i>Net 7€</i>

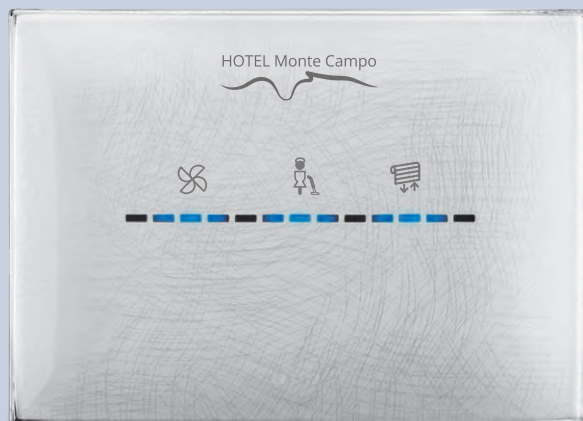
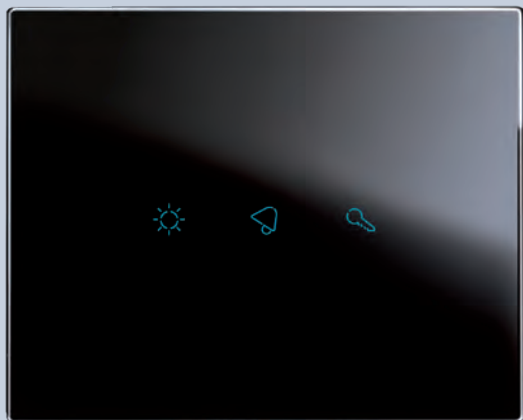



# Placche personalizzabili

Customizable front plates



Placche "Ave Touch" in vetro per scatola tonda o quadrata - PERSONALIZZABILI

"Ave Touch" glass front plates for round or square box - CUSTOMIZABLE

276



44PVTc22NAL/XX

Descrizione Description

Info

€

□

□

□ 44PVTc22BL/XX

Bianco Lucido - 2 moduli

Clear White - 2 modules

a commessa  
upon request

1 1

■ 44PVTc22GO/XX

Grigio argentato finitura opaca - 2 moduli

Frosted silver grey - 2 modules

a commessa  
upon request

1 1

■ 44PVTc22GOLD/XX

Oro finitura lucida - 2 moduli

Frosted gold - 2 modules

a commessa  
upon request

1 1

■ 44PVTc22NAL/XX

Nero assoluto finitura lucida - 2 moduli

Clear absolute black - 2 modules

a commessa  
upon request

1 1

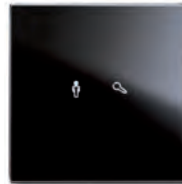
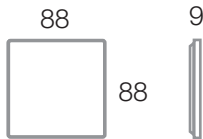

Placche "Ave Touch" in vetro per scatola 3 moduli (interasse 83,5 mm) - PERSONALIZZABILI

"Ave Touch" glass front plates for rectangular 3 modules box (fixing centres 83,5 mm) - CUSTOMIZABLE



44PVTc3NAL/XX

Descrizione Description

Info

€

□

□

□ 44PVTc3BL/XX

Bianco Lucido - 3 moduli

Clear White - 3 modules

a commessa  
upon request

1 1

■ 44PVTc3GO/XX

Grigio argentato finitura opaca - 3 moduli

Frosted silver grey - 3 modules

a commessa  
upon request

1 1

■ 44PVTc3GOLD/XX

Oro finitura lucida - 3 moduli

Frosted gold - 3 modules

a commessa  
upon request

1 1

■ 44PVTc3NAL/XX

Nero assoluto finitura lucida - 3 moduli

Clear absolute black - 3 modules

a commessa  
upon request

1 1

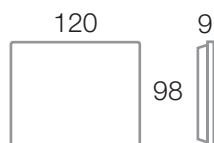

Per la disponibilità contattare la rete commerciale  
For availability please contact sales dept.



Disponibilità fino ad esaurimento scorte  
Available until stock out



Prodotto per scatola rettangolare inglese  
Product for British standard rectangular box



Prodotto per Export  
For Export only

Placche "Ave Touch" in vetro per scatola 4 moduli (interasse 108,5 mm) - PERSONALIZZABILI  
 "Ave Touch" glass front plates for rectangular 4 modules box (fixing centres 108,5 mm) - CUSTOMIZABLE

	Descrizione Description	Info	€	<input type="checkbox"/>	<input type="checkbox"/>
 44PVTC4NAL/XX	<input type="checkbox"/> <b>44PVTC4BL/XX</b> Bianco Lucido - 4 moduli <i>Clear White - 4 modules</i>	a commessa upon request		1	1
	<input checked="" type="checkbox"/> <b>44PVTC4GO/XX</b> Grigio argentato finitura opaca - 4 moduli <i>Frosted silver grey - 4 modules</i>	a commessa upon request		1	1
	<input checked="" type="checkbox"/> <b>44PVTC4GOLD/XX</b> Oro finitura lucida - 4 moduli <i>Frosted gold - 4 modules</i>	a commessa upon request		1	1
	<input checked="" type="checkbox"/> <b>44PVTC4NAL/XX</b> Nero assoluto finitura lucida - 4 moduli <i>Clear absolute black - 4 modules</i>	a commessa upon request		1	1

277

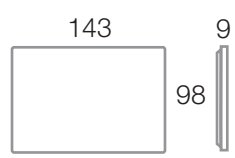

Placche "Ave Touch" in vetro per scatola 6-7 moduli (interasse 158,5 mm) - PERSONALIZZABILI  
 "Ave Touch" glass front plates for rectangular 6-7 modules box (fixing centres 158,5 mm) - CUSTOMIZABLE

	Descrizione Description	Info	€	<input type="checkbox"/>	<input type="checkbox"/>
 44PVTC7NAL/XX	<input type="checkbox"/> <b>44PVTC7BL/XX</b> Bianco Lucido - 6-7 moduli <i>Clear White - 6-7 modules</i>	a commessa upon request		1	1
	<input checked="" type="checkbox"/> <b>44PVTC7GO/XX</b> Grigio argentato finitura opaca - 6-7 moduli <i>Frosted silver grey - 6-7 modules</i>	a commessa upon request		1	1
	<input checked="" type="checkbox"/> <b>44PVTC7GOLD/XX</b> Oro finitura lucida - 6-7 moduli <i>Frosted gold - 6-7 modules</i>	a commessa upon request		1	1
	<input checked="" type="checkbox"/> <b>44PVTC7NAL/XX</b> Nero assoluto finitura lucida - 6-7 moduli <i>Clear absolute black - 6-7 modules</i>	a commessa upon request		1	1

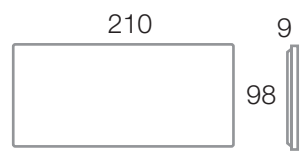

Le dimensioni, salvo diversamente specificato, sono in mm  
 Dimensions, except where otherwise specified, are in mm

Imballo Minimo pcs  
 Min. Packaging pcs

Imballo Standard pcs  
 Std. Packaging pcs



# Placche personalizzabili

Customizable front plates



Placche "Ave Touch" per scatola BL02P - PERSONALIZZABILI

"Ave Touch" front plates for BL02P box - CUSTOMIZABLE

278



44PVT33NAL/XX

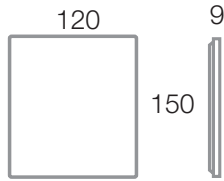

## Descrizione Description

Info

€



### □ 44PVT33BL/XX

Vetro Bianco Lucido - 6(3+3) moduli  
Clear White glass - 6(3+3) modules

a commessa  
upon request

1 1

### ■ 44PVT33GO/XX

Vetro Grigio argentato finitura opaca - 6(3+3) moduli  
Frosted silver grey glass - 6(3+3) modules

a commessa  
upon request

1 1

### ■ 44PVT33NAL/XX

Vetro Nero assoluto finitura lucida - 6(3+3) moduli  
Clear absolute black glass - 6(3+3) modules

a commessa  
upon request

1 1

## Placche "Ave Touch" in vetro per Gestione Alberghiera

"Ave Touch" glass front plates for Hotel Management System

## Descrizione Description

Info

€



44PVT33GA-NAL

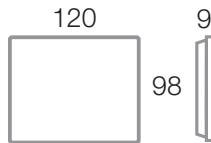

### □ 44PVT33GA-BL

Bianco Lucido - 3 moduli  
Clear White - 3 modules

a commessa  
upon request

1 1

### ■ 44PVT33GA-NAL

Nero assoluto finitura lucida - 3 moduli  
Clear absolute black - 3 modules

a commessa  
upon request

1 1

### □ 44PVT33GA-BL

Vetro Bianco Lucido - con pulsante chiamata  
per controllo accessi 442GA02-M  
6(3+3) moduli  
Clear White glass - 6(3+3) modules

a commessa  
upon request

1 1



44PVT33GA-NAL

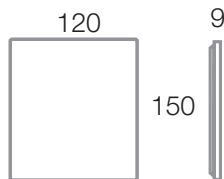

### ■ 44PVT33GA-NAL

Vetro Nero assoluto finitura lucida  
con pulsante chiamata  
per controllo accessi 442GA02-M  
6(3+3) moduli  
Clear absolute black glass - 6(3+3) modules

a commessa  
upon request

1 1

### □ 44PVT76GA-BL

Vetro Bianco Lucido  
per controllo accessi 442GA02-M  
6(3+3) moduli  
Clear White glass - 6(3+3) modules

a commessa  
upon request

1 1



44PVT76GA-NAL

### ■ 44PVT76GA-NAL

Vetro Nero assoluto finitura lucida - con pulsante  
chiamata - per controllo accessi 442GA02-M  
6(3+3) moduli  
Clear absolute black glass - 6(3+3) modules

a commessa  
upon request

1 1



Per la disponibilità contattare  
la rete commerciale  
For availability please contact  
sales dept.



Disponibilità fino ad  
esaurimento scorte  
Available until stock out







Prodotto per scatola  
rettangolare inglese  
Product for British standard  
rectangular box



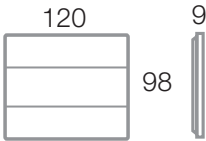

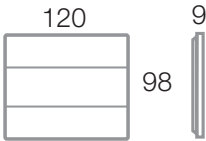

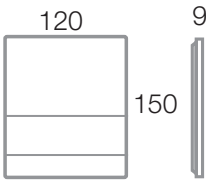



Prodotto  
per Export  
For Export  
only

## Placche "Ave Touch" in alluminio per Gestione Alberghiera "Ave Touch" aluminium front plates for Hotel Management System

		Descrizione Description	Info	€	<input type="checkbox"/>	<input type="checkbox"/>	279
		<b>44PATC3GA-ALS</b> ■ <b>44PATC3GA-ANS</b> Placca Touch in alluminio gestione alberghiera - per scatola 3 moduli (interasse 83,5 mm) - personalizzabile - per lettore 442GA02-M. <i>Hotel management aluminum touch plate - for 3-module box (83.5 mm center distance) - customizable - for 442GA02-M reader.</i>	a commessa upon request		<input type="checkbox"/>	<input type="checkbox"/>	1 1
		<b>44PATC33GA-ALS</b> ■ <b>44PATC33GA-ANS</b> Placca Touch in alluminio con pulsante gestione alberghiera - per scatola BL02P - 6(3+3) moduli - personalizzabile - per lettore 442GA02-M. <i>Aluminum touch plate with hotel management push button - for BL02P box - 6(3+3) modules - customizable - for 442GA02-M reader.</i>	a commessa upon request		<input type="checkbox"/>	<input type="checkbox"/>	1 1
		<b>44PATC76GA-ALS</b> ■ <b>44PATC76GA-ANS</b> Placca Touch in alluminio gestione alberghiera - per scatola BL02P - 6(3+3) moduli - personalizzabile - per lettore 442GA02-M. <i>Hotel management aluminum touch plate - for BL02P box - 6(3+3) modules - customizable - for 442GA02-M reader.</i>	a commessa upon request		<input type="checkbox"/>	<input type="checkbox"/>	1 1

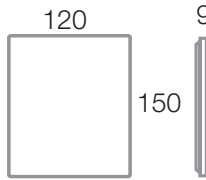

## Placche "Pills" in corian® per Gestione Alberghiera "Pills" corian® front plates for Hotel Management System

		Descrizione Description	Info	€	<input type="checkbox"/>	<input type="checkbox"/>	
		<b>44PCTC3GA-B</b> Placca Touch in Corian® - per gestione alberghiera - colore bianco opaco - 3 moduli - personalizzabile. Supporto da utilizzare 44A03 <i>Touch front plate in Corian® - for hotel management - matt white color - 3 modules - customizable. Support to use 44A03</i>	a commessa upon request 		<input type="checkbox"/>	<input type="checkbox"/>	1 1
		<b>44PCTC33GA-B</b> Placca Touch in Corian® con gemma per chiamata - per gestione alberghiera - colore bianco opaco - per scatola BL02P - 3+3 moduli - personalizzabile. Supporto da utilizzare 44A033 <i>Touch front plate in Corian® with call gem - for hotel management - matt white color - for BL02P box - 3+3 modules - customizable. Support to use 44A033</i>	a commessa upon request 		<input type="checkbox"/>	<input type="checkbox"/>	1 1
		<b>44PCTC76GA-B</b> Placca Touch in Corian® senza gemma - per gestione alberghiera - colore bianco opaco - per scatola BL02P - 3+3 moduli - personalizzabile. Supporto da utilizzare 44A033 <i>Touch front plate in Corian® without gem - for hotel management - matt white color - for BL02P box - 3+3 modules - customizable. Support to use 44A033</i>	a commessa upon request 		<input type="checkbox"/>	<input type="checkbox"/>	1 1



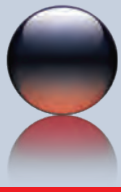

# Placche multimodulo personalizzabili

## Customizable multi-module front plates



BREVETTO AVE N° 205-209-212-227  
AVE PATENT N° 205-209-212-227

280

## Prezzi personalizzazione per singola placca

Customization prices for each front plates

**Lotto minimo ordinabile 20 pezzi**

### Costi

Il costo per ciascuna placca è quello riportato nel presente catalogo a cui deve essere aggiunto un costo una **tantum** pari a **450 € netti**.  
Da distribuire sul numero di pezzi oggetto dell'ordine, per singola personalizzazione.

Per verificarne la fattibilità e i costi contattare la rete commerciale Ave.

**Minimum order quantity 20 pcs**

### Costs

The cost for each front plate is the one indicated in the official International Price List in force with the **addition** of the first prototype fee of **€ 450**  
To be distributed over the number of pieces subject to the order, for each customization.

Please check costs and feasibility with Ave export sales department.

Caratteristiche Tecniche Technical Features

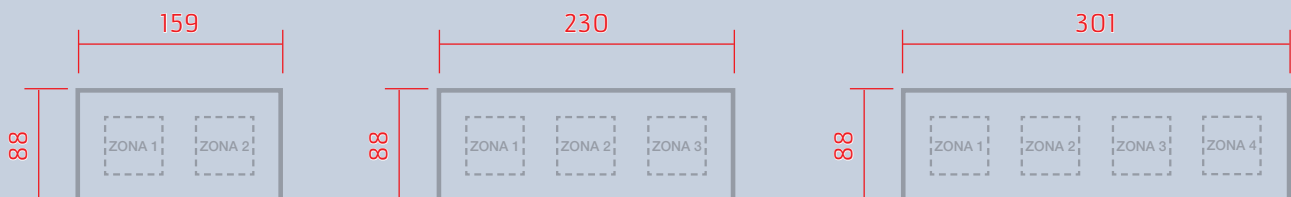

Per la disponibilità contattare  
la rete commerciale  
For availability please contact  
sales dept.



Disponibilità fino ad  
esaurimento scorte  
Available until stock out



Prodotto per scatola  
rettangolare inglese  
Product for British standard  
rectangular box

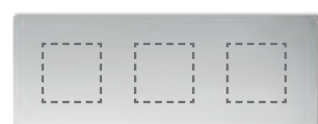
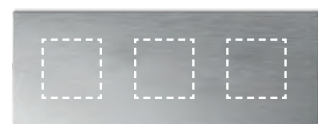
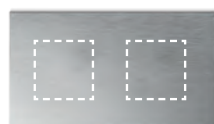
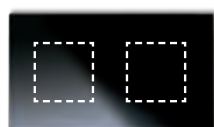

Prodotto  
per Export  
For Export  
only

**Descrizione** *Description*
**Info**

€ □ □

**Vetro** *Glass*

44PV24BL-XX	Bianco finitura lucida <i>Clear white</i>	a commessa upon request	1	1
44PV24GO-XX	Grigio argentato finitura opaca <i>Frosted silver grey</i>	a commessa upon request	1	1
44PV24GOLD-XX	Oro finitura lucida <i>Clear gold</i>	a commessa upon request	1	1
44PV24NAL-XX	Nero assoluto finitura lucida <i>Clear absolute black</i>	a commessa upon request	1	1
44PV26BL-XX	Bianco finitura lucida <i>Clear white</i>	a commessa upon request	1	1
44PV26GO-XX	Grigio argentato finitura opaca <i>Frosted silver grey</i>	a commessa upon request	1	1
44PV26GOLD-XX	Oro finitura lucida <i>Clear gold</i>	a commessa upon request	1	1
44PV26NAL-XX	Nero assoluto finitura lucida <i>Clear absolute black</i>	a commessa upon request	1	1
44PV28BL-XX	Bianco finitura lucida <i>Clear white</i>	a commessa upon request	1	1
44PV28GO-XX	Grigio argentato finitura opaca <i>Frosted silver grey</i>	a commessa upon request	1	1
44PV28GOLD-XX	Oro finitura lucida <i>Clear gold</i>	a commessa upon request	1	1
44PV28NAL-XX	Nero assoluto finitura lucida <i>Clear absolute black</i>	a commessa upon request	1	1

**Alluminio** *Aluminium*

44PA24ALS-XX	Alluminio naturale spazzolato <i>Natural brushed aluminium</i>	a commessa upon request	1	1
44PA24ANS-XX	Alluminio antracite spazzolato <i>Anthracite brushed aluminium</i>	a commessa upon request	1	1
44PA24GOLD-XX	Alluminio oro spazzolato <i>Gold brushed aluminium</i>	a commessa upon request	1	1
44PA26ALS-XX	Alluminio naturale spazzolato <i>Natural brushed aluminium</i>	a commessa upon request	1	1
44PA26ANS-XX	Alluminio antracite spazzolato <i>Anthracite brushed aluminium</i>	a commessa upon request	1	1
44PA26GOLD-XX	Alluminio oro spazzolato <i>Gold brushed aluminium</i>	a commessa upon request	1	1
44PA28ALS-XX	Alluminio naturale spazzolato <i>Natural brushed aluminium</i>	a commessa upon request	1	1
44PA28ANS-XX	Alluminio antracite spazzolato <i>Anthracite brushed aluminium</i>	a commessa upon request	1	1
44PA28GOLD-XX	Alluminio oro spazzolato <i>Gold brushed aluminium</i>	a commessa upon request	1	1

**Corian®**

44PCT24B-XX	Bianco <i>White</i>	a commessa upon request	1	1
44PCT26B-XX	Bianco <i>White</i>	a commessa upon request	1	1
44PCT28B-XX	Bianco <i>White</i>	a commessa upon request	1	1

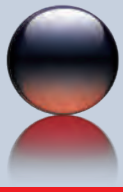

# Personalizzazione tasti

## Customizable rockers



I simboli di personalizzazione, sono quelli riportati nella tabella "simbologie disponibili". I prezzi sono quelli indicati nella "tabella prezzi" e sono da dividere in base alle quantità, esempio 20 tasti Serie Domus 1 modulo con simbologia diverse il prezzo è da distribuire sui 20 pezzi. Tale operazione è da ripetere in caso di cambio della Serie o cambio di modulo.

The customization symbols are mentioned in the "available symbols" table. The prices are indicated in the "price table" and are to be divided according to the quantities, for example: 20 rockers Domus Series 1 module with different symbols the price is to be distributed over the 20 pieces. This operation is to be repeated in case of change of series or module.



Life



Allumia

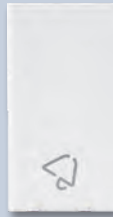

Whitek



Tekla



Domus



Class

### Simbologie disponibili

Available symbols

1	2	3	4	5	6	7	8	9	10	11	12
13	14	15	16	17	18	19	20	21	22	23	24
25 <b>FM</b>	26	27	28	29 <b>OFF</b>	30 <b>ON</b>	31 <b>ALARM</b>	32 <b>DO NOT DISTURB</b>	33 <b>RESET</b>	34 <b>APRE</b>	35 <b>CHIUDE</b>	36 <b>AVANTI</b>
37 <b>ESTERNO</b>	38 <b>GARAGE</b>	39 <b>CANTINA</b>	40 <b>GIARDINO</b>	41 <b>GENERALE</b>	42 <b>LUCE</b>	43 <b>RIPOSTIGLIO</b>	44 <b>SCALE</b>	45 <b>SOLAIO</b>	46 <b>TERRAZZA</b>	47 <b>INDIETRO</b>	48 <b>BAGNO</b>

### Tablelle prezzi

Simbologia da libreria, da distribuire sul numero di pezzi:

Price tables  
Library symbols, to be distributed over the number of pieces:

Quantità Quantity	Prezzi Price
<b>Fino a 20 pezzi</b> Until 20 pcs	<b>Netto 15€</b> Unit 15€
<b>Da 21 pz. a 50 pezzi</b> From 21 pcs to 50 pcs	<b>Netto 10€</b> Unit 10€
<b>Da 51 pz. a 100 pezzi</b> From 51 pcs to 100 pcs	<b>Netto 6€</b> Unit 6€

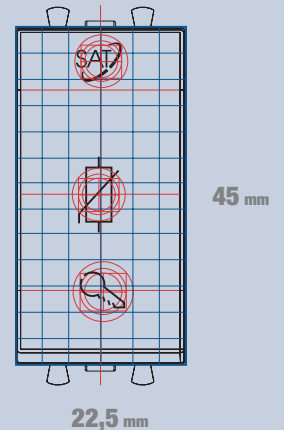

Per la disponibilità contattare la rete commerciale  
For availability please contact sales dept.



Disponibilità fino ad esaurimento scorte  
Available until stock out



Prodotto per scatola rettangolare inglese  
Product for British standard rectangular box



Prodotto per Export  
For Export only

Descrizione Description	Info	€	<input type="checkbox"/>	<input type="checkbox"/>
<b>VALIGETTA2020</b> Valigetta campionario Sistema 44 completa serie Domus, Life, Allumia, Class, Tekla e New Style <i>Sample case System 44 - Domus, Life, Allumia, Class, Tekla and New Style series</i>			1	1

283



Sistema 45



**VALIGETTA2020**

Le dimensioni, salvo diversamente specificato, sono in mm  
Dimensions, except where otherwise specified, are in mm

Imballo Minimo pcs  
Min. Packaging pcs

Imballo Standard pcs  
Std. Packaging pcs