

Placche delle Serie Civili

Sistema 45

System 45

Wiring Accessories front plates



Design:

A. Van Onck
M. Hasuike
H.M.R.
B. Dall'Eco
L. Merletti

Indice
Index

Placche
Banquise 45
Banquise 45 front plates

336



Placche
Zama 45
Zama 45 front plates

338



Placche
RAL 45
RAL 45 front plates

341

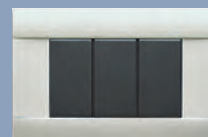

Placche
Yes 45
Yes 45 front plates

345



Placche
Blanc 45
Blanc 45 front plates

349

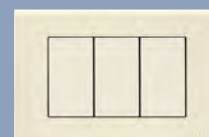



Placche

Front Plates

Sistema 45

Placche in metallo "Banquise" con inserto illuminabile per scatola rettangolare
 "Banquise" metal front plates with lightable insert for rectangular boxes

Design:
M. Hasuike

336

3 MODULI / 3 MODULES



Cod. Code	Descrizione Description	Info	€	□	□
45PB93BMC	Bianco Banquise micalizzato Mica-finished Banquise white	1 15			
45PB93GSM	Grigio scuro metallizzato Metallic dark grey	1 15			
45PB93NCS	Nichel spazzolato Brushed nickel	1 15			
45PB930T	Ottone lucido Polished brass	1 15			

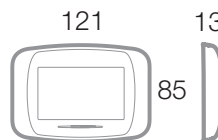

Supporto da utilizzare
To be used with



45B63

4 MODULI / 4 MODULES



Cod. Code	Descrizione Description	Info	€	□	□
45PB94BMC	Bianco Banquise micalizzato Mica-finished Banquise white	1 14			
45PB94GSM	Grigio scuro metallizzato Metallic dark grey	1 14			
45PB940T	Ottone lucido Polished brass	1 14			

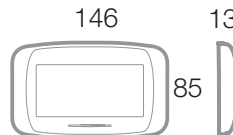

Supporto da utilizzare
To be used with



45764

6 MODULI / 6 MODULES



Cod. Code	Descrizione Description	Info	€	□	□
45PB96BMC	Bianco Banquise micalizzato Mica-finished Banquise white	1 10			

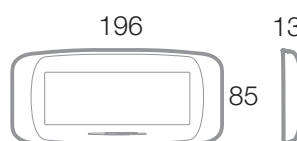

Supporto da utilizzare
To be used with



45366



Per la disponibilità contattare la rete commerciale
For availability please contact sales dept.



Disponibilità fino ad esaurimento scorte
Available until stock out



Prodotto 2 moduli adatto anche per scatola tonda
2 modules product suitable for round box



Prodotto per scatola rettangolare inglese
Product for British standard rectangular box



Prodotto per Export
For Export only

Placche in tecnopolimero "Banquise" per scatola rettangolare "Banquise" moulded front plates for rectangular boxes

Design:
M. Hasuike

3 MODULI / 3 MODULES	Cod. Code	Descrizione Description	Info	€	□	□
 45PB03BB	45PB03BB	Bianco Banquise (RAL 9016) <i>Banquise white (RAL 9016)</i>	1	25		
	45PB03BP	Bianco Blanc (RAL 1013) <i>Blanc white (RAL 1013)</i>	1	25		
	45PB03GSM	Grigio scuro metallizzato <i>Metallic dark grey</i>	1	25		
	45PB03NL	Nero lucido <i>Polished black</i>	1	25		

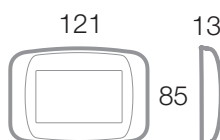

Supporto da utilizzare
To be used with



45B63



Sistema 45

Placche in tecnopolimero "Banquise" per scatola rettangolare "Banquise" moulded front plates for rectangular boxes

4 MODULI / 4 MODULES	Cod. Code	Descrizione Description	Info	€	□	□
 45PB04BB	45PB04BB	Bianco Banquise (RAL 9016) <i>Banquise white (RAL 9016)</i>	1	20		
	45PB04BP	Bianco Blanc (RAL 1013) <i>Blanc white (RAL 1013)</i>	1	20		
	45PB04GSM	Grigio scuro metallizzato <i>Metallic dark grey</i>	1	20		
	45PB04NL	Nero lucido <i>Polished black</i>	1	20		

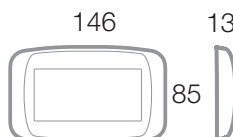

Supporto da utilizzare
To be used with



45764

Placche in tecnopolimero "Banquise" per scatola rettangolare "Banquise" moulded front plates for rectangular boxes

6 MODULI / 6 MODULES	Cod. Code	Descrizione Description	Info	€	□	□
 45PB06BB	45PB06BB	Bianco Banquise (RAL 9016) <i>Banquise white (RAL 9016)</i>	1	15		
	45PB06GSM	Grigio scuro metallizzato <i>Metallic dark grey</i>	1	15		
	45PB06NL	Nero lucido <i>Polished black</i>	1	15		

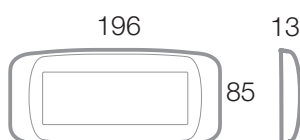

Supporto da utilizzare
To be used with



45366

Le dimensioni, salvo diversamente specificato, sono in mm
Dimensions, except where otherwise specified, are in mm

◆ Prodotto per scatola quadrata
Product for British Standard
square box only

② Prodotto 1 modulo installabile in scatola tonda
con altro prodotto 1 modulo
1 module product installable in round box with
another 1 module device

□ Imballo Minimo pcs
Min. Packaging pcs

□ Imballo Standard pcs
Std. Packaging pcs



Placche Front Plates

Sistema 45

Placche in metallo "Zama 45" per scatola rettangolare
"Zama 45" metal front plates for rectangular boxes

Design:
M. Hasuike

338

3 MODULI / 3 MODULES



45P93AM



45P93BG



45P93BP



45P93CR



45P93GSM



45P93BMC



45P93NL

Cod. Code	Descrizione Description	Info	€	□	□
45P93AM	Argento metallizzato Metallic silver	1	15		
45P93BG	Bianco Banquise (RAL 9016) Banquise white (RAL 9016)	1	15		
45P93BMC	Bianco Banquise micalizzato Mica-finished Banquise white	1	15		
45P93BP	Bianco Blanc (RAL 1013) Blanc white (RAL 1013)	1	15		
45P93CR	Cromo Chrome	1	15		
45P93GSM	Grigio scuro metallizzato Metallic dark grey	1	15		
45P93NL	Nero lucido Polished black	1	15		

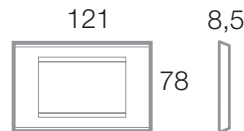

Supporto da utilizzare
To be used with



45B63

Placche in metallo "Zama 45" per scatola rettangolare
"Zama 45" metal front plates for rectangular boxes

4 MODULI / 4 MODULES



Cod. Code	Descrizione Description	Info	€	□	□
45P94AM	Argento metallizzato Metallic silver	1	14		
45P94BG	Bianco Banquise (RAL 9016) Banquise white (RAL 9016)	1	14		
45P94BP	Bianco Blanc (RAL 1013) Blanc white (RAL 1013)	1	14		
45P94CR	Cromo Chrome	1	14		
45P94GSM	Grigio scuro metallizzato Metallic dark grey	1	14		

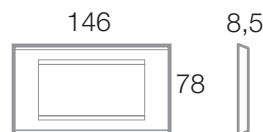

Supporto da utilizzare
To be used with



45764



Per la disponibilità contattare
la rete commerciale
For availability please contact
sales dept.



Disponibilità fino ad
esaurimento scorte
Available until stock out



Prodotto 2 moduli adatto
anche per scatola tonda
2 modules product suitable
for round box



Prodotto per scatola
rettangolare inglese
Product for British standard
rectangular box



Prodotto
per Export
For Export
only

Placche in metallo "Zama 45" per scatola rettangolare

"Zama 45" metal front plates for rectangular boxes

Design:
M. Hasuike

6 MODULI / 6 MODULES	Cod. Code	Descrizione Description	Info	€	□	□	339
	45P96BG	Bianco Banquise (RAL 9016) <i>Banquise white (RAL 9016)</i>	1	10			
	45P96CR	Cromo <i>Chrome</i>	1	10			
	45P96GSM	Grigio scuro metallizzato <i>Metallic dark grey</i>	1	10			
	45P96TT	Ottone lucido <i>Polished brass</i>	1	10			

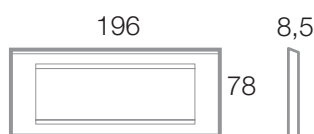

Supporto da utilizzare

To be used with



45366



Sistema 45

Placche "antisalinità"

L'installazione in ambienti soggetti all'influenza del mare (ad esempio le imbarcazioni) o con presenza di soluzioni saline, può provocare, alle normali placche, un precoce deterioramento della verniciatura. Per ovviare a questo problema Ave ha inserito le "placche antisalinità" che, grazie ad un rivoluzionario processo di verniciatura, garantiscono una maggior resistenza nel tempo alla finitura originale. Ave offre la possibilità di avere questo trattamento solo sulle seguenti 5 colorazioni: bianco Banquise (BG), bianco Blanc (BP), cromo (CR), ottone (TT), radica (RD). Modalità di ordinazione: indicare nell'ordine, dopo il codice della placca desiderata, "con trattamento antisalinità".

Anti-salinity front plates

The installation in environments close to the sea (for example the boats) or where salt solutions are present, can cause a premature deterioration of the paint in normal kind of front plates. In order to solve this problem, Ave proposes the anti-salinity front plates: thanks to a revolutionary process of paint, they guarantee a greater resistance through the time. Ave can offer this special paint in the following colours: Banquise white (BG), Blanc white (BP), Chrome (CR), Brass (TT), Briarwood (RD). How to order them: indicate on your purchase order "with anti-salinity treatment" after the front plate code.



Le dimensioni, salvo diversamente specificato, sono in mm
Dimensions, except where otherwise specified, are in mm

◆ Prodotto per scatola quadrata
Product for British Standard
square box only

② Prodotto 1 modulo installabile in scatola tonda
con altro prodotto 1 modulo
1 module product installable in round box with
another 1 module device

□ Imballo Minimo pcs
Min. Packaging pcs

□ Imballo Standard pcs
Std. Packaging pcs



Placche in metallo "antivandalo" per scatole rettangolari
"Anti-vandal" metal front plates for rectangular boxes

Design:
M. Hasuike

340

	Cod. Code	Descrizione Description	Info	€	□	□
	45P93TIAV	Placca "antivandalo" 3 moduli - fissaggio al supporto con viti speciali che non permettono il distacco della placca se non con l'utilizzo di un apposito attrezzo - fornita con supporto speciale - colore titanio "Anti-vandal" front plate 3 modules - particular fixing system to the frame with special screws that do not allow to remove the plate except by an appropriate tool - provided with special frame - brushed nickel colour	1	1		
	45P94TIAV	Placca "antivandalo" 4 moduli - fissaggio al supporto con viti speciali che non permettono il distacco della placca se non con l'utilizzo di un apposito attrezzo - fornita con supporto speciale - colore titanio "Anti-vandal" front plate 4 modules - particular fixing system to the frame with special screws that do not allow to remove the plate except by an appropriate tool - provided with special frame - titanium colour	1	1		

Nota: fornite con supporto speciale
Note: supplied with special frame



Sequenza installativa Installation

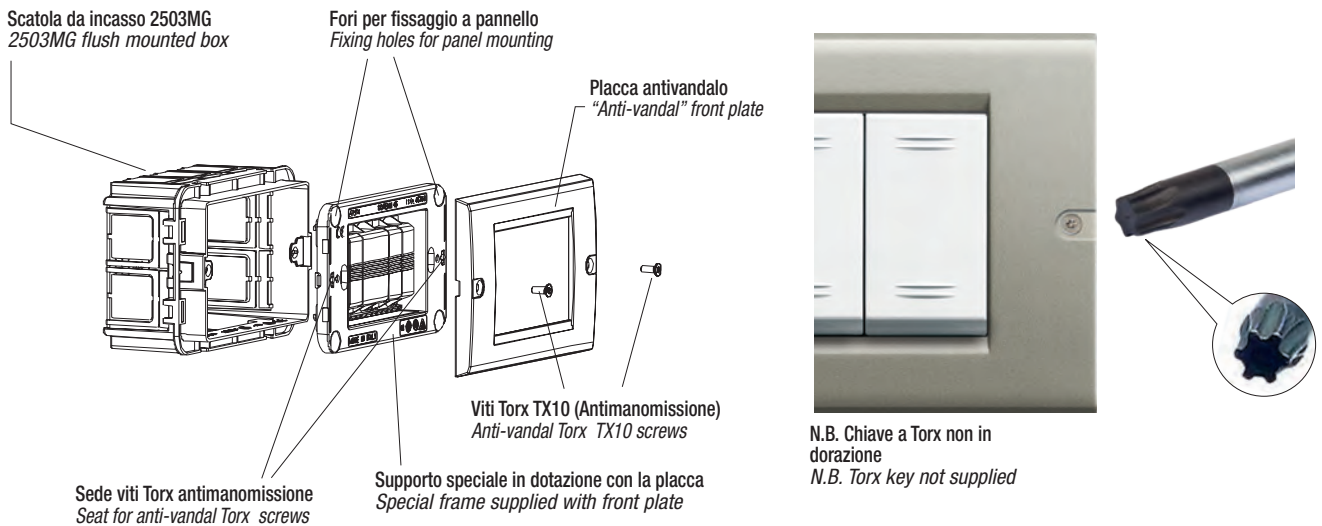

Accessori Accessories

	Cod. Code	Descrizione Description	Info	€	□	□
	25GS	Ganci metallici di ricambio per scatole porta frutti 3 e 4 moduli Spare metallic hooks for 3 and 4 modules boxes	2	2		



Per la disponibilità contattare la rete commerciale
For availability please contact sales dept.



Disponibilità fino ad esaurimento scorte
Available until stock out



Prodotto 2 moduli adatto anche per scatola tonda
2 modules product suitable for round box



Prodotto per scatola rettangolare inglese
Product for British standard rectangular box



Prodotto per Export
For Export only

Placche in tecnopolimero "Ral 45" sabbiate "Ral 45" matt finish moulded front plates

Design:
H. M. R.

341

1 MODULO / 1 MODULE



Cod. Code	Descrizione Description	Info	€	<input type="checkbox"/>	<input type="checkbox"/>
45P01BP	Bianco Blanc (RAL 1013) Blanc white (RAL 1013)	1	25		
45P01GN	Grigio Noir Noir grey	1	25		

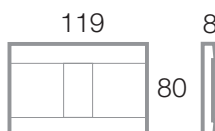

Supporto da utilizzare
To be used with



45B63

2 Moduli 2 Modules



Cod. Code	Descrizione Description	Info	€	<input type="checkbox"/>	<input type="checkbox"/>
45P02GN	Grigio Noir Noir grey	1	25		

Nota: con il supporto 45B63 sono installabili centralmente solo i prodotti del Sistema 45 contrassegnati, nella colonna "Info", con i simboli • e ②
Note: with the 45B63 frame, only system 45 products with the symbols • and ② in the "info" column can be installed centrally

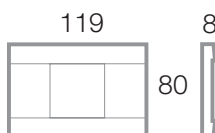

Supporti da utilizzare
To be used with



45762



45B63

2 (1+1) Moduli 2 (1+1) Modules



Cod. Code	Descrizione Description	Info	€	<input type="checkbox"/>	<input type="checkbox"/>
45P002BP	Bianco Blanc (RAL 1013) Blanc white (RAL 1013)	1	25		
45P002GN	Grigio Noir Noir grey	1	25		
45P002R	Grigio RAL 7035 7035 RAL grey	1	25		

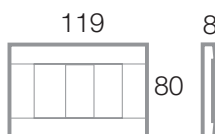

Supporto da utilizzare
To be used with



45B63

Le dimensioni, salvo diversamente specificato, sono in mm
Dimensions, except where otherwise specified, are in mm

◆ Prodotto per scatola quadrata
Product for British Standard
square box only

② Prodotto 1 modulo installabile in scatola tonda
con altro prodotto 1 modulo
1 module product installable in round box with
another 1 module device

Imballo Minimo pcs
Min. Packaging pcs

Imballo Standard pcs
Std. Packaging pcs



3 Moduli 3 Modules

Design:
H. M. R.

342



45P03R

Cod. Code	Descrizione Description	Info	€	□	□
45P03BP	Bianco Blanc (RAL 1013) <i>Blanc white (RAL 1013)</i>	1	25		
45P03GN	Grigio Noir <i>Noir grey</i>	1	25		
45P03R	Grigio RAL 7035 <i>7035 RAL grey</i>	1	25		



45P03GN



45P03BP

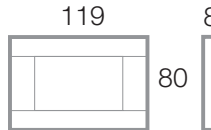

Supporto da utilizzare
To be used with



45B63

4 Moduli 4 Modules



Cod. Code	Descrizione Description	Info	€	□	□
45P04BP	Bianco Blanc (RAL 1013) <i>Blanc white (RAL 1013)</i>	1	20		
45P04GN	Grigio Noir <i>Noir grey</i>	1	20		
45P04R	Grigio RAL 7035 <i>7035 RAL grey</i>	1	20		

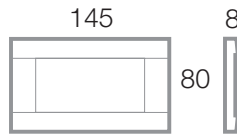

Supporto da utilizzare
To be used with



45764

6 Moduli 6 Modules



Cod. Code	Descrizione Description	Info	€	□	□
45P06BP	Bianco Blanc (RAL 1013) <i>Blanc white (RAL 1013)</i>	1	15		
45P06GN	Grigio Noir <i>Noir grey</i>	1	15		

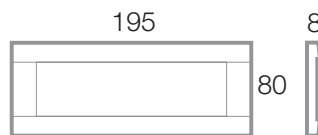

Supporto da utilizzare
To be used with



45366



Per la disponibilità contattare
la rete commerciale
For availability please contact
sales dept.



Disponibilità fino ad
esaurimento scorte
Available until stock out



Prodotto 2 moduli adatto
anche per scatola tonda
2 modules product suitable
for round box



Prodotto per scatola
rettangolare inglese
Product for British standard
rectangular box



Prodotto
per Export
For Export
only

Placche in tecnopolimero "Ral 45" lucide "Ral 45" glossy finish moulded front plates

Design:
M. Hasuike

343

1 MODULO / 1 MODULE



Cod. Code	Descrizione Description	Info	€	□	□
45P01BG	Bianco Banquise (RAL 9016) Banquise white (RAL 9016)		1	25	

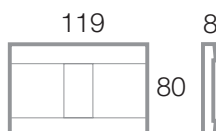

Supporto da utilizzare
To be used with



45B63

2 Moduli 2 Modules



Cod. Code	Descrizione Description	Info	€	□	□
45P02BG	Bianco Banquise (RAL 9016) Banquise white (RAL 9016)		1	25	

Nota: con il supporto 45B63 sono installabili centralmente solo i prodotti del Sistema 45 contrassegnati, nella colonna "Info", con i simboli • e ②
Note: with the 45B63 frame, only system 45 products with the symbols • and ② in the "info" column can be installed centrally

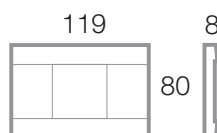

Supporti da utilizzare
To be used with



45762



45B63

2 (1+1) Moduli 2 (1+1) Modules



Cod. Code	Descrizione Description	Info	€	□	□
45P002BG	Bianco Banquise (RAL 9016) Banquise white (RAL 9016)		1	25	

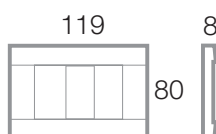

Supporto da utilizzare
To be used with



45B63

Le dimensioni, salvo diversamente specificato, sono in mm
Dimensions, except where otherwise specified, are in mm

◆ Prodotto per scatola quadrata
Product for British Standard
square box only

② Prodotto 1 modulo installabile in scatola tonda
con altro prodotto 1 modulo
1 module product installable in round box with
another 1 module device

□ Imballo Minimo pcs
Min. Packaging pcs

□ Imballo Standard pcs
Std. Packaging pcs



3 Moduli 3 Modules

Design:
M. Hasuike

344



45P03BG

Cod. Code	Descrizione Description	Info	€	□	□
45P03BG	Bianco Banquise (RAL 9016) Banquise white (RAL 9016)	1 25			
45P03NL	Nero lucido Polished black	1 25			



45P03NL

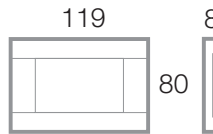

Supporto da utilizzare
To be used with



45B63

4 Moduli 4 Modules

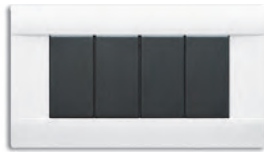

Cod. Code	Descrizione Description	Info	€	□	□
45P04BG	Bianco Banquise (RAL 9016) Banquise white (RAL 9016)	1 20			

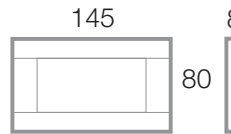

Supporto da utilizzare
To be used with



45764

6 Moduli 6 Modules

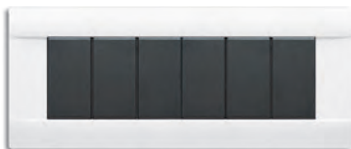

Cod. Code	Descrizione Description	Info	€	□	□
45P06BG	Bianco Banquise (RAL 9016) Banquise white (RAL 9016)	1 15			

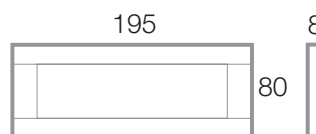

Supporto da utilizzare
To be used with



45366



Per la disponibilità contattare
la rete commerciale
For availability please contact
sales dept.



Disponibilità fino ad
esaurimento scorte
Available until stock out



Prodotto 2 moduli adatto
anche per scatola tonda
2 modules product suitable
for round box



Prodotto per scatola
rettangolare inglese
Product for British standard
rectangular box



Prodotto
per Export
For Export
only

Placche in tecnopolimero "Yes 45" per scatola rettangolare
 "Yes 45" series moulded front plates - rectangular box

Design:
H. M. R.

1 MODULO / 1 MODULE



Cod. Code	Descrizione Description	Info	€	□	□
45PY01BB	Bianco Banquise (RAL 9016) Banquise white (RAL 9016)	1	25		
45PY01BP	Bianco Blanc (RAL 1013) Blanc white (RAL 1013)	1	25		
45PY01GN	Grigio Noir Noir grey	1	25		

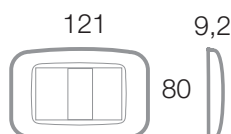

Supporto da utilizzare
To be used with



45B63



Sistema 45

2 (1+1) Moduli 2 (1+1) Modules



Cod. Code	Descrizione Description	Info	€	□	□
45PY002BB	Bianco Banquise (RAL 9016) Banquise white (RAL 9016)	1	25		
45PY002BP	Bianco Blanc (RAL 1013) Blanc white (RAL 1013)	1	25		
45PY002GN	Grigio Noir Noir grey	1	25		

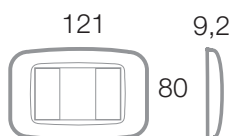

Supporto da utilizzare
To be used with



45B63

2 Moduli 2 Modules



Cod. Code	Descrizione Description	Info	€	□	□
45PY02BB	Bianco Banquise (RAL 9016) Banquise white (RAL 9016)	1	25		
45PY02BP	Bianco Blanc (RAL 1013) Blanc white (RAL 1013)	1	25		
45PY02GN	Grigio Noir Noir grey	1	25		

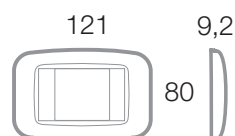

Supporto da utilizzare
To be used with



45762



45B63

Le dimensioni, salvo diversamente specificato, sono in mm
 Dimensions, except where otherwise specified, are in mm

◆ Prodotto per scatola quadrata
Product for British Standard
square box only

② Prodotto 1 modulo installabile in scatola tonda
con altro prodotto 1 modulo
1 module product installable in round box with
another 1 module device

□ Imballo Minimo pcs
Min. Packaging pcs

□ Imballo Standard pcs
Std. Packaging pcs



3 Moduli 3 Modules

Design:
H. M. R.

346



Cod. Code	Descrizione Description	Info	€	□	□
45PY03AO	Argento opaco <i>Matt silver</i>	1 25			
45PY03BB	Bianco Banquise (RAL 9016) <i>Banquise white (RAL 9016)</i>	1 25			
45PY03BP	Bianco Blanc (RAL 1013) <i>Blanc white (RAL 1013)</i>	1 25			
45PY03CHO	Champagne opaco <i>Champagne</i>	1 25			
45PY03GN	Grigio Noir <i>Noir grey</i>	1 25			
45PY03GSM	Grigio scuro metallizzato <i>Metallic dark grey</i>	1 25			

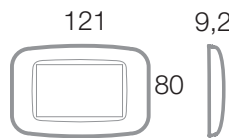

Supporto da utilizzare
To be used with



45B63

Design:
H. M. R.

Placche in tecnopolimero "Yes 45" per scatola rettangolare
"Yes 45" series moulded front plates - rectangular box

4 MODULI / 4 MODULES



Cod. Code	Descrizione Description	Info	€	□	□
45PY04AO	Argento opaco <i>Matt silver</i>	1 20			
45PY04BB	Bianco Banquise (RAL 9016) <i>Banquise white (RAL 9016)</i>	1 20			
45PY04BP	Bianco Blanc (RAL 1013) <i>Blanc white (RAL 1013)</i>	1 20			
45PY04GN	Grigio Noir <i>Noir grey</i>	1 20			
45PY04GSM	Grigio scuro metallizzato <i>Metallic dark grey</i>	1 20			

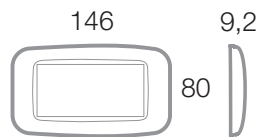

Supporto da utilizzare
To be used with



45764

6 Moduli 6 Modules



Cod. Code	Descrizione Description	Info	€	□	□
45PY06AO	Argento opaco <i>Matt silver</i>	1 15			
45PY06BB	Bianco Banquise (RAL 9016) <i>Banquise white (RAL 9016)</i>	1 15			
45PY06BP	Bianco Blanc (RAL 1013) <i>Blanc white (RAL 1013)</i>	1 15			
45PY06GN	Grigio Noir <i>Noir grey</i>	1 15			

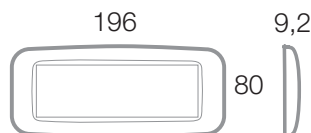

Per la disponibilità contattare
la rete commerciale
For availability please contact
sales dept.



Disponibilità fino ad
esaurimento scorte
Available until stock out



Prodotto 2 moduli adatto
anche per scatola tonda
2 modules product suitable
for round box



Prodotto per scatola
rettangolare inglese
Product for British standard
rectangular box



Prodotto
per Export
For Export
only

1 Modulo 1 Module

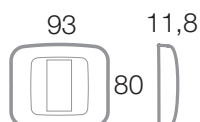

Cod. Code	Descrizione Description	Cornicetta Adapter frame	Info	€	□	□
45P21BB	Bianco Banquise (RAL 9016) Banquise white (RAL 9016)	Bianco Banquise (RAL 9016) Banquise white (RAL 9016)	1	30		
45P21BP	Bianco blanc (RAL 1013) Blanc white (RAL 1013)	Bianco Blanc (RAL 1013) Blanc white (RAL 1013)	1	30		

347

Sistema 45
Supporto da utilizzare
To be used with

45362EX
2 Moduli 2 Modules

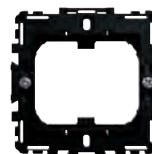
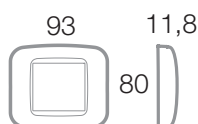
45P22BB

Cod. Code	Descrizione Description	Cornicetta Adapter frame	Info	€	□	□
45P22BB	Bianco Banquise (RAL 9016) Banquise white (RAL 9016)	Bianco Banquise (RAL 9016) Banquise white (RAL 9016)	1	30		
45P22BP	Bianco blanc (RAL 1013) Blanc white (RAL 1013)	Bianco Blanc (RAL 1013) Blanc white (RAL 1013)	1	30		

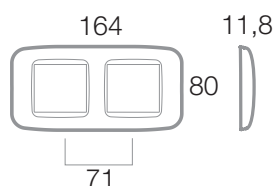
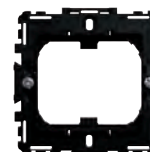
Supporto da utilizzare
To be used with

45362EX
4 (2+2) Moduli 4 (2+2) Modules

 Installazione orizzontale o
verticale
Horizontal and vertical
installation

Supporto da utilizzare
To be used with

n° 2 45362EX

 Le dimensioni, salvo diversamente specificato, sono in mm
Dimensions, except where otherwise specified, are in mm

 Prodotto per scatola quadrata
Product for British Standard
square box only

 Prodotto 1 modulo installabile in scatola tonda
con altro prodotto 1 modulo
1 module product installable in round box with
another 1 module device

 Imballo Minimo pcs
Min. Packaging pcs

 Imballo Standard pcs
Std. Packaging pcs



Placche

Front Plates

Sistema 45

Placche in tecnopolimero "Yes 45" per scatola tonda o quadrata
 "Yes 45" series moulded front plates - square or round box

Design:
H. M. R.

348

6(2+2+2) MODULI / 6(2+2+2) MODULES	Cod. Code	Descrizione Description	Cornicetta Adapter frame	Info	€	□	□
------------------------------------	-----------	-------------------------	--------------------------	------	---	---	---



45P26BB	Bianco Banquise (RAL 9016) Banquise white (RAL 9016)	Bianco Banquise (RAL 9016) Banquise white (RAL 9016)	1	30
---------	---	---	---	----

Installazione orizzontale o vertical
Horizontal and vertical installation

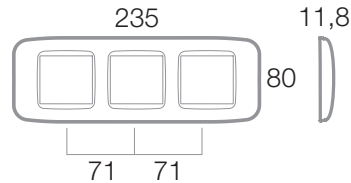

Supporto da utilizzare
To be used with



n° 3 45362EX

Accessori placche in tecnopolimero "Yes 45" per scatola tonda o quadrata
 "Yes 45" series moulded front plates accessories - square or round box

1 MODULO / 1 MODULE	Cod. Code	Descrizione Description	Info	€	□	□
---------------------	-----------	-------------------------	------	---	---	---



45CR1BB	Cornice di ricambio 1 mod. color Banquise (RAL 9016) Banquise white (RAL 9016) 1 module spare adapter frame	5	100
45CR1BP	Cornice di ricambio 1 mod. color Blanc (RAL 1013) Blanc (RAL 1013) white 1 module spare adapter frame	5	100

Placche autoportanti in tecnopolimero "Yesmin" "Yesmin" series self-supporting moulded front plates

Cod. Code	Descrizione Description	Info	€	□	□
-----------	-------------------------	------	---	---	---



45PA1BB



45PA1BB	Bianco Banquise (RAL 9016) Banquise white (RAL 9016)	10	10
45PA2BB	Bianco Banquise (RAL 9016)- con griffe Banquise white (RAL 9016) - with clips	10	10

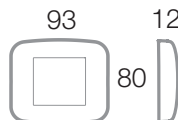

Placche in tecnopolimero multimodulo "Maxi Yes" per scatola BL02P
 Multi-module "Maxi Yes" series moulded front plates - for BL02P box

Design:
H. M. R.

Cod. Code	Descrizione Description	Info	€	□	□
-----------	-------------------------	------	---	---	---



45PY020BB	Bianco Banquise (RAL 9016) Banquise white (RAL 9016)	1	16
-----------	---	---	----

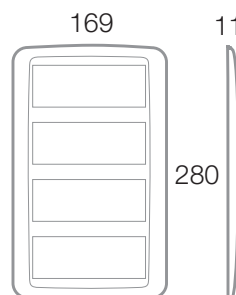

Supporto da utilizzare
To be used with



45760/20



Per la disponibilità contattare la rete commerciale
For availability please contact sales dept.



Disponibilità fino ad esaurimento scorte
Available until stock out



Prodotto 2 moduli adatto anche per scatola tonda
2 modules product suitable for round box



Prodotto per scatola rettangolare inglese
Product for British standard rectangular box



Prodotto per Export
For Export only

Placche in tecnopolimero "Blanc 45" "BLANC 45" moulded front plates

Design:
H. M. R.

349

3 MODULI / 3 MODULES



45P63

Cod. Code **Descrizione Description**

45P63 Bianco Blanc (RAL 1013)
Blanc white (RAL 1013)

Info

€ □ □

1 25

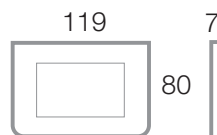

Supporto da utilizzare
To be used with



45B63

1 Modulo 1 Module



45P61

Cod. Code **Descrizione Description**

45P61 Bianco Blanc (RAL 1013)
Blanc white (RAL 1013)

Info

€ □ □

1 25

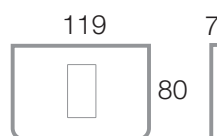

Supporto da utilizzare
To be used with



45B63

1+1 Moduli 1+1 Modules

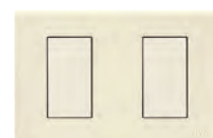

Cod. Code **Descrizione Description**

45P62 Bianco Blanc (RAL 1013)
Blanc white (RAL 1013)

Info

€ □ □

1 25

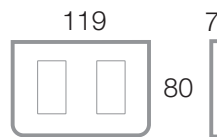

Supporto da utilizzare
To be used with



45B63

4 Moduli 4 Modules



Cod. Code **Descrizione Description**

45P64 Bianco Blanc (RAL 1013)
Blanc white (RAL 1013)

Info

€ □ □

1 20

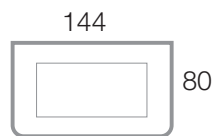

Supporto da utilizzare
To be used with



45764

Le dimensioni, salvo diversamente specificato, sono in mm
Dimensions, except where otherwise specified, are in mm

◆ Prodotto per scatola quadrata
Product for British Standard
square box only

② Prodotto 1 modulo installabile in scatola tonda
con altro prodotto 1 modulo
1 module product installable in round box with
another 1 module device

□ Imballo Minimo pcs
Min. Packaging pcs

□ Imballo Standard pcs
Std. Packaging pcs

Supporti e contenitori **Sistema 45**

System 45 Frames and enclosures

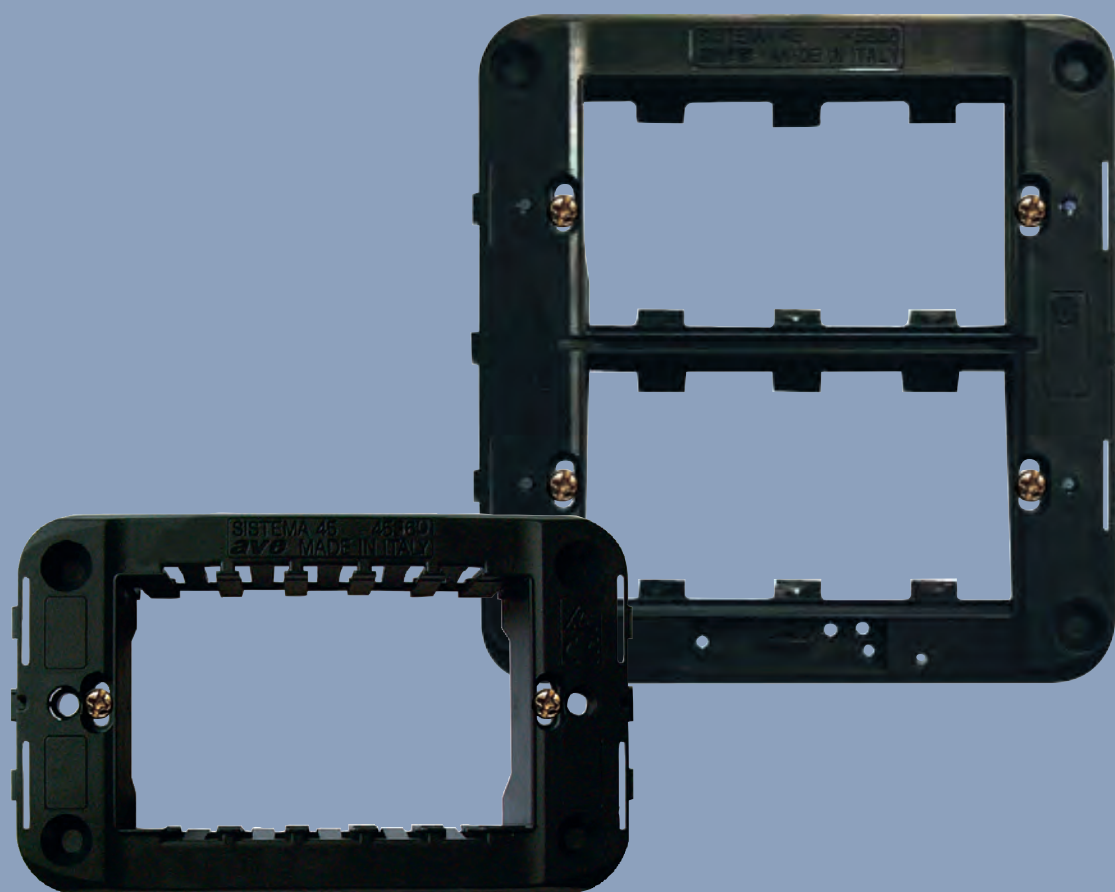

Design:
B. Dall'Eco
L. Merletti

Indice
Index

Supporti
Frames

352



Contenitori
Enclosures

354







Supporti per scatole tonde e quadrate
Frames for round and square boxes

352

	Cod. Code	Descrizione Description	Info	€	□	□
	45361	Supporto 1 modulo per scatola tonda 60mm per placche 45PY01..., 45P01..., 45P31, 45P61 <i>1 module frame for 60mm round box for plates 45PY01..., 45P01..., 45P31, 45P61</i>		50	50	
45361						
	45762	Supporto 2 moduli affiancati per placche 45P02... - 45P92... - 45PB02... - 45PY02...45P622 - 45P722 - installabile su scatola quadrata con interasse 60mm (cod. AVE 2502) o standard rettangolare (cod. AVE 2503MG) 3 moduli <i>2 modules frame to be used with front plates 45P02...- 45P92... 45P622 - 45P722 - it can be installed on square boxes with centre distance 60 mm (code AVE 2502) or 3 modules rectangular standard (AVE code 2503MG)</i>		50	50	
45762						
	45362EX	Supporto 1-2 moduli per scatola quadrata o tonda 60mm - accoppiabile in orizzontale o verticale - con griffe laterali <i>1-2 modules frame with side clips for squared or 60mm round boxes - it can be coupled either vertically or horizontally</i>		70	70	
45362EX						

Supporti per scatole rettangolari Frames for rectangular boxes

	Cod. Code	Descrizione Description	Info	€	□	□
	45B63	Supporto 1-3 moduli per scatole 2503MG <i>1-3 modules frame for 2503MG boxes</i>		120	120	
45B63						
	45366	Supporto 6 moduli per scatole 2506 <i>6 modules frame for 2506 boxes</i>		8	8	
45762						
	45764	Supporto 2 moduli affiancati per placche 45P02... - 45P92... - 45PB02... - 45PY02...45P622 - 45P722 - installabile su scatola quadrata con interasse 60mm (cod. AVE 2502) o standard rettangolare (cod. AVE 2503MG) - 3 moduli <i>2 modules frame to be used with front plates 45P02...-45P92... - 45PB02...45PY02...45P622 - 45P722 - it can be installed on square boxes with centre distance 60 mm (code AVE 2502) or 3 modules rectangular standard (AVE code 2503MG)</i>		50	50	
45764						
	45764	Supporto 4 moduli per scatole 2504 <i>4 modules frame for 2504 boxes</i>		15	15	
45366						
	45B66	Supporto 6 moduli (3+3) per scatole BL02P <i>6 modules frame (3+3) for BL02P boxes</i>		8	8	
45B66						



Per la disponibilità contattare la rete commerciale
For availability please contact sales dept.



Disponibilità fino ad esaurimento scorte
Available until stock out



Prodotto 2 moduli adatto anche per scatola tonda
2 modules product suitable for round box



Prodotto per scatola rettangolare inglese
Product for British standard rectangular box



Prodotto per Export
For Export only

Supporti speciali Special frames

Cod. Code	Descrizione Description	Info	€	□	□
45360	Supporto 1-3 moduli per l'installazione di tutti i prodotti che per ragioni di dimensioni non possono essere installati nei supporti standard sistema 45 Ave quali: - prese rasoio cod. 45...33RS - microautomatici 3KA cod. 45...52NX6, 45...52NX10, 45...52NX16 - magnetotermici differenziali cod. 45...62NX6, 45...62NX10, 45...62NX16 <i>1-3 modules special frame for the devices that do not fit a standard S45 frame. The products that require this special frame are:</i> - Shaver socket (45...33RS) - 3kA Micro MCBs (45...52NX6, 45...52NX10, 45...52NX16) - Micro combined MCB/RCDs (45...62NX6, 45...62NX10, 45...62NX16)	1	12		
45364	Come sopra ma per 1-4 moduli <i>As above, for 1-4 modules</i>	1	12		



45360



45364

Nota: permettono inoltre, tramite gli appositi adattatori forniti in dotazione, di alloggiare tutti i frutti standard del sistema 45 Ave (vedi figura sotto riportata)
Note: All standard S45 modules can be fitted to these frames by using the dedicated adaptors (see picture below)

Esempio di installazione su Supporto 45360:
microinterruttore + presa schuko bipasso del Sistema 45 AVE
Installation example 45369 Special Use Frame, micro MCB + System 45 schuko socket

I prodotti del Sistema 45 con aggancio standard si montano sui supporti 45360 - 45364 con l'utilizzo degli adattatori in dotazione con il supporto.

System 45 products with standard clippings are fitted to Ref. 45360 and 45364 with the adaptors provided with the frames.

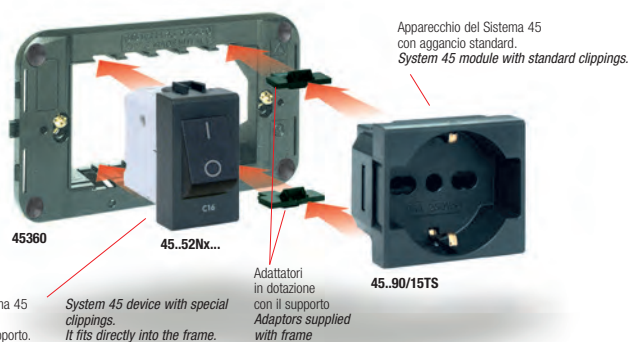

Supporti per moduli multipli Multi-module frames

Cod. Code	Descrizione Description	Info	€	□	□
45760/10	Supporto 10 moduli per scatole 53SA05, 53SA05BG, BL05P, BL05CG, 45SY10, 45SY10AO <i>10 modules frame for 53SA05, 53SA05BG, BL05P, 45SY10, 45SY10AO boxes</i>	1	1		
45760/20	Supporto 20 moduli per scatole BL07P, 53SA12BG, , 45SY20AO <i>20 modules frame for BL07P, 53SA12BG, , 45SY20AO boxes</i>	1	1		



45760/10



45760/20

Rimozione setto separatore
Divider removal



Le dimensioni, salvo diversamente specificato, sono in mm
Dimensions, except where otherwise specified, are in mm

◇ Prodotto per scatola quadrata
Product for British Standard square box only

② Prodotto 1 modulo installabile in scatola tonda con altro prodotto 1 modulo
1 module product installable in round box with another 1 module device

□ Imballo Minimo pcs
Min. Packaging pcs

□ Imballo Standard pcs
Std. Packaging pcs



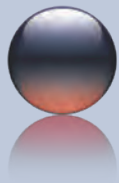

Dimensioni d'ingombro (in mm) *Dimensions (mm)*

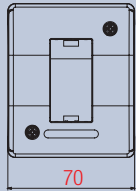

45Q41

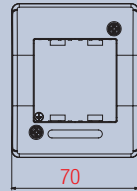
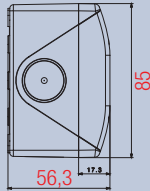

45Q42

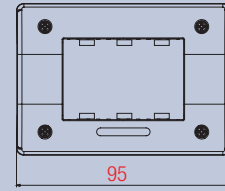
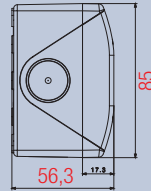

45Q43

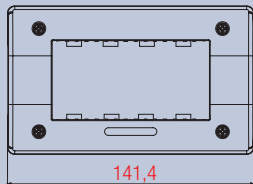
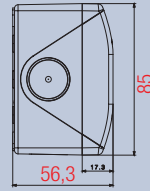

45Q44

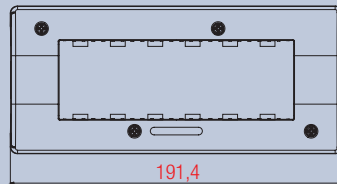
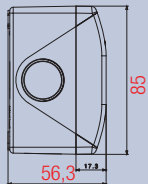

45Q46

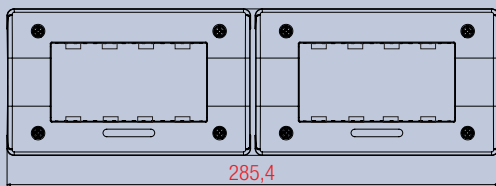
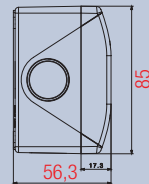

45Q480R

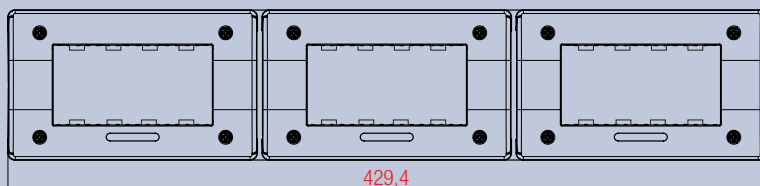
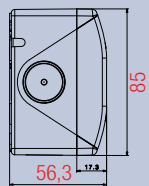

45Q4120R

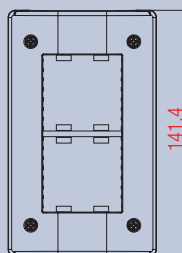
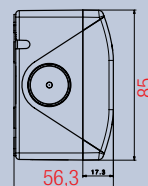

45Q44V

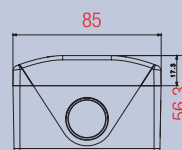

Caratteristiche Tecniche *Technical Features*



Per la disponibilità contattare la rete commerciale
For availability please contact sales dept.



Disponibilità fino ad esaurimento scorte
Available until stock out



Prodotto 2 moduli adatto anche per scatola tonda
2 modules product suitable for round box







Prodotto per scatola rettangolare inglese
Product for British standard rectangular box



Prodotto per Export
For Export only

Contenitori industriali autoportanti IP40 da parete RAL7035 per tubo
IP40 indust. wall mounted enclosures for duct - self-supporting - RAL7035

	Cod. Code	Descrizione Description	Info	€	<input type="checkbox"/>	<input type="checkbox"/>
	45Q41	1 modulo <i>1 module</i>		24	<input type="checkbox"/>	<input type="checkbox"/>
	45Q42	2 moduli <i>2 modules</i>		24	<input type="checkbox"/>	<input type="checkbox"/>
	45Q43	3 moduli <i>3 modules</i>		20	<input type="checkbox"/>	<input type="checkbox"/>
	45Q44	4 moduli <i>4 modules</i>		20	<input type="checkbox"/>	<input type="checkbox"/>
	45Q44V	4 (2+2) moduli - installazione verticale <i>4 (2+2) modules - vertical installation</i>		20	<input type="checkbox"/>	<input type="checkbox"/>
	45Q43	6 moduli <i>6 modules</i>		1	<input type="checkbox"/>	<input type="checkbox"/>
	45Q44	8 (4+4) moduli - installazione orizzontale <i>8 (4+4) modules - horizontal installation</i>		1	<input type="checkbox"/>	<input type="checkbox"/>
	45Q4120R	12 (4+4+4) moduli - installazione orizzontale <i>12 (4+4+4) modules - horizontal installation</i>		1	<input type="checkbox"/>	<input type="checkbox"/>

355



Sistema 45



45Q41



45Q42



45Q43



45Q44

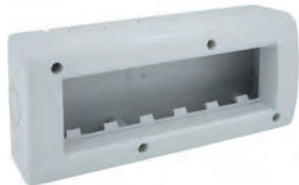

45Q46



45Q44V

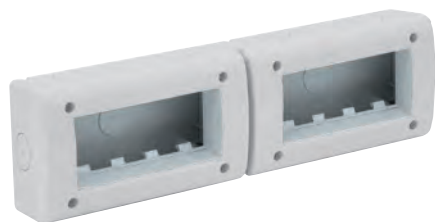

45Q480R



45Q4120R

Le dimensioni, salvo diversamente specificato, sono in mm
 Dimensions, except where otherwise specified, are in mm

Prodotto per scatola quadrata
 Product for British Standard square box only

Prodotto 1 modulo installabile in scatola tonda con altro prodotto 1 modulo
 1 module product installable in round box with another 1 module device

Imballo Minimo pcs
 Min. Packaging pcs

Imballo Standard pcs
 Std. Packaging pcs

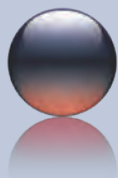

Dimensioni d'ingombro (in mm) *Dimensions (mm)*

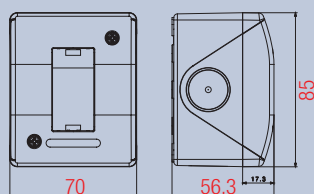
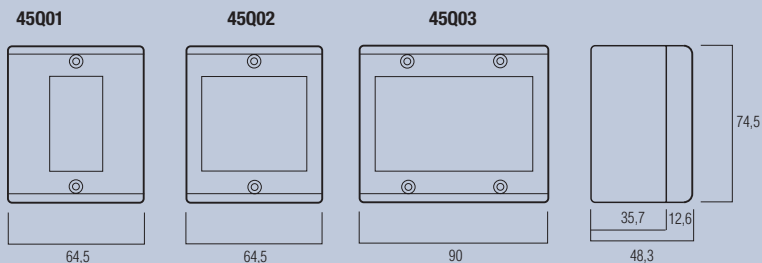

45Q41B

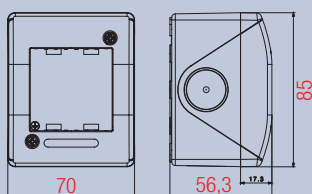

45Q42B

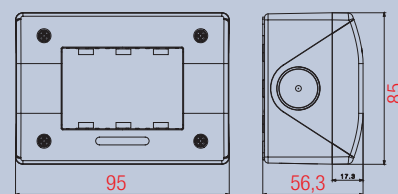

45Q43B

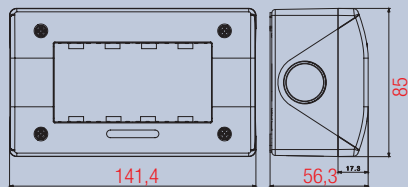

45Q44B

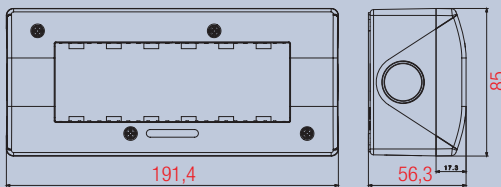

45Q46B

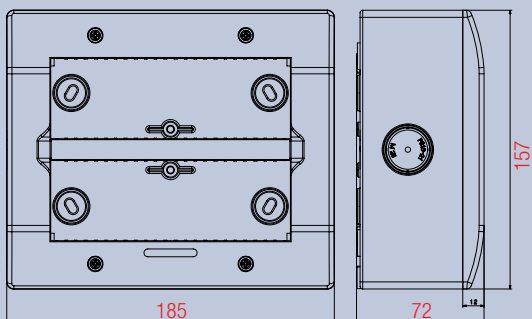

45Q412B

Caratteristiche Tecniche *Technical Features*



Per la disponibilità contattare la rete commerciale
For availability please contact sales dept.



Disponibilità fino ad esaurimento scorte
Available until stock out



Prodotto 2 moduli adatto anche per scatola tonda
2 modules product suitable for round box





Prodotto per scatola rettangolare inglese
Product for British standard rectangular box



Prodotto per Export
For Export only

Contenitori autoportanti IP40 da parete RAL1013

IP40 wall mounted enclosures - self-supporting - RAL1013

		Cod. Code	Descrizione Description	Info	€	□	□
		45Q01	1 modulo 1 module		30	30	
		45Q02	2 moduli 2 modules		30	30	
		45Q03	3 moduli 3 modules		24	24	
		45Q03					







357



Sistema 45

Contenitori industriali autoportanti IP40 da parete RAL 9016 per tubo

IP40 indust. wall mounted enclosures for duct- self-supporting - RAL 9016

		Cod. Code	Descrizione Description	Info	€	□	□
		45Q41B	1 modulo 1 module		24	24	
		45Q42B	2 moduli 2 modules		24	24	
		45Q43B	3 moduli 3 modules		20	20	
		45Q44B	4 moduli 4 modules		20	20	
		45Q43B					
		45Q44B					
		45Q46B	6 moduli 6 modules		1	10	
		45Q412B	12 (6+6) moduli 12 (6+6) modules		1	6	
		45Q46B					
		45Q412B					

Le dimensioni, salvo diversamente specificato, sono in mm
Dimensions, except where otherwise specified, are in mm

◇ Prodotto per scatola quadrata
Product for British Standard square box only

② Prodotto 1 modulo installabile in scatola tonda con altro prodotto 1 modulo
1 module product installable in round box with another 1 module device

□ Imballo Minimo pcs
Min. Packaging pcs

□ Imballo Standard pcs
Std. Packaging pcs



Scatole portafrutto da parete RAL 9016 per placche "YES 45" - per minicanale
Wall mounted boxes for "YES 45" front plates RAL 9016 - for mini trunkings

358



45SY2

Cod. Code	Descrizione Description	Info	€	□	□
45SY2	1-2 moduli - colore bianco Banquise <i>1-2 modules Banquise white box</i>	1	30		

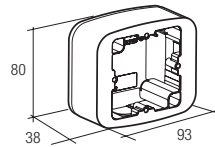

45SY2

Scatole portafrutto da parete per placche "Ral 45" e "Zama 45"
Wall mounted boxes for "Ral 45" and "Zama 45" front plates

Cod. Code	Descrizione Description	Info	€	□	□
-----------	-------------------------	------	---	---	---



45SA03



45SA03GN

45SA03	Scatola d'arredo 3 moduli bianco Banquise (RAL 9016) - da utilizzare con supporti standard 3 moduli - completare con placche codice 45P93... o 45P03... <i>3 modules white box to be used with System 45 3 modules frames to be completed with 45P93... or 45P03... front plates</i>	1	16		
--------	---	---	----	--	--

45SA03GN	Scatola d'arredo 3 moduli grigio Noir - da utilizzare con supporti standard 3 moduli. - completare con placche codice 45P93... o 45P03... <i>3 modules Noir grey box to be used with System 45 3 modules frames to be completed with 45P93... or 45P03... front plates</i>	1	16		
----------	---	---	----	--	--



45CI03

45CI03	Cornice rialzatrice inclinata 3 moduli bianco Banquise (RAL 9016) <i>3 modules Banquise white (RAL 9016) angled raiser frame</i>	1	1		
--------	---	---	---	--	--

Scatole e contenitori da tavolo Desktop box and enclosures

Cod. Code	Descrizione Description	Info	€	□	□
-----------	-------------------------	------	---	---	---



45SI03GN



45TL3BMC

45SI03GN	Scatola inclinata 3 moduli grigio Noir - da utilizzare con supporti standard 3 moduli - completare con placche codice 45P93... o 45P03... <i>3 modules Noir grey angled box to be used with System 45 3 modules frames to be completed with 45P93... or 45P03... front plates</i>	1	1		
----------	--	---	---	--	--

45TL3BMC	Contenitore autoportante da tavolo 3 moduli bianco Banquise (RAL 9016) - completo di placca color bianco Banquise micalizzato <i>3 modules Banquise white (RAL 9016) desktop enclosure with mica-finished Banquise white front plate</i>	1	12		
----------	---	---	----	--	--



Per la disponibilità contattare la rete commerciale
For availability please contact sales dept.



Disponibilità fino ad esaurimento scorte
Available until stock out



Prodotto 2 moduli adatto anche per scatola tonda
2 modules product suitable for round box



Prodotto per scatola rettangolare inglese
Product for British standard rectangular box



Prodotto per Export
For Export only

Placche stagne (IP55) autoportanti con sportello con membrana cedibile IP55 front plates with soft membrane cover - self-supporting

Cod. Code	Descrizione Description	Info	€	□	□
45SP43N	Placca 3 moduli stagna con membrana - autoportante (non necessita di supporto portafrutti) - grigio RAL 7035 <i>IP55 splashproof 3 modules front plate with soft membrane cover - self-supporting (no frame is required) - RAL 7035 grey</i>	6	6		
45SP43BN	Placca 3 moduli stagna con membrana - autoportante (non necessita di supporto portafrutti) - bianco Banquise (RAL 9016) <i>IP55 splashproof 3 modules front plate with soft membrane cover - self-supporting (no frame is required) - Banquise white (RAL 9016)</i>	6	6		
45SP43BPN	Placca 3 moduli stagna con membrana - autoportante (non necessita di supporto portafrutti) - bianco Blanc (RAL 1013) <i>IP55 splashproof 3 modules front plate with soft membrane cover - self-supporting (no frame is required) - Blanc white (RAL 1013)</i>	6	6		
45SP43GM	Placca 3 moduli stagna con membrana - autoportante (non necessita di supporto portafrutti) - grigio metallizzato <i>IP55 splashproof 3 modules front plate with soft membrane cover - self-supporting (no frame is required) - Metallic grey</i>	6	6		
45SP44	Placca 4 moduli stagna con membrana - autoportante (non necessita di supporto portafrutti) grigio RAL 7035 <i>4 modules splash proof front plate - self-supporting (no frame is required) - RAL 7035 grey</i>	6	6		
45SP44B	Placca 4 moduli stagna con membrana autoportante (non necessita di supporto portafrutti) bianco Banquise (RAL 9016) <i>4 modules splash proof front plate - self-supporting (no frame is required) - Banquise white (RAL 9016)</i>	6	6		

Nota: grado di protezione garantito IP55 con apparecchi di comando o altri apparecchi modulari che consentano la chiusura dello sportello nella condizione ordinaria di servizio
Note: IP55 protection degree guaranteed with control devices or other modular devices that allow the closure of the cover in ordinary performing conditions

Placche stagne (IP44) con sportello rigido IP44 front plates with rigid cover

Cod. Code	Descrizione Description	Info	€	□	□
45SPQ02	Placca 2 moduli con sportello rigido - autoportante (non necessita di supporto portafrutti) - fissaggio con viti su scatola quadrata con interasse 60mm - RAL 7035 <i>IP44 2 modules front plate with rigid cover - self-supporting (no frame is required) To be fixed by screws on square box interax 60mm - RAL 7035</i>	13,06	1	8	

Nota: grado di protezione garantito IP44 con apparecchi di comando o altri apparecchi modulari che consentano la chiusura dello sportello nella condizione ordinaria di servizio
Note: IP44 protection degree guaranteed with control devices or other modular devices that allow the closure of the lid in ordinary performing conditions

Installazione Installation



Le dimensioni, salvo diversamente specificato, sono in mm
Dimensions, except where otherwise specified, are in mm

◇ Prodotto per scatola quadrata
Product for British Standard square box only

② Prodotto 1 modulo installabile in scatola tonda con altro prodotto 1 modulo
1 module product installable in round box with another 1 module device

□ Imballo Minimo pcs
Min. Packaging pcs

□ Imballo Standard pcs
Std. Packaging pcs

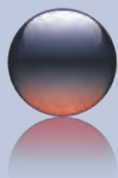

Contenitori

Enclosures

Contenitori stagni (IP55) autoportanti da parete RAL 7035 con sportello a membrana cedibile per tubo
IP55 wall mounted enclosures RAL 7035 with soft membrane cover - self-supporting for duct

360

Dimensioni d'ingombro (in mm) *Dimensions (mm)*

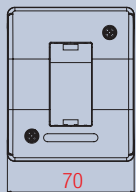

45Q41B

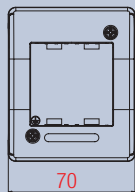
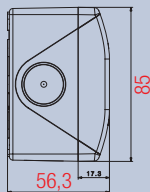

45Q42B

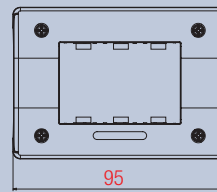
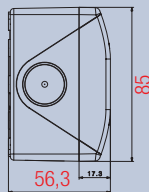

45Q43B

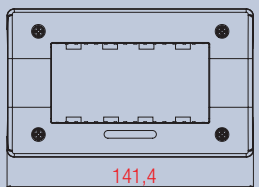
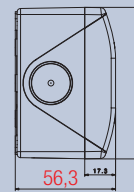

45Q44B

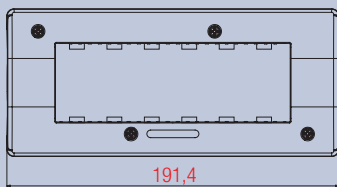
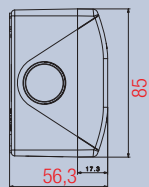

45Q46B

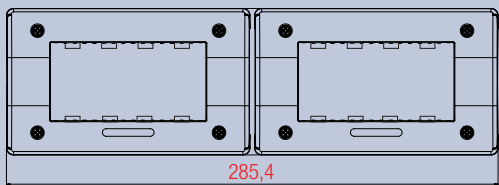
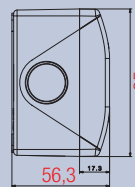

45Q480R

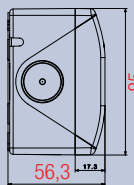

Caratteristiche Tecniche *Technical Features*

Soluzioni IP55/IP66 multiple da parete per tubo

Wall mounted double enclosures IP55/IP66 solutions for duct

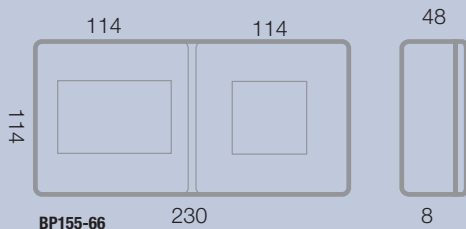

BP155-66

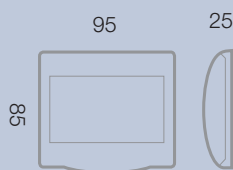

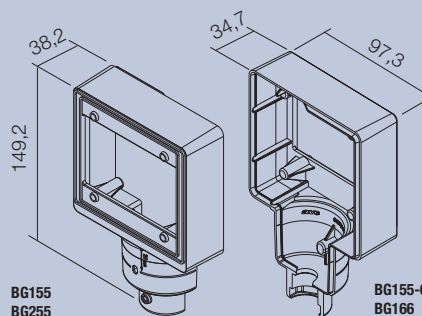

45SP43K



BG155
BG255

BG155-66
BG166
BG266

Contenitori stagni (IP55) autoportanti da parete RAL 7035 con sportello a membrana cedibile per tubo IP55 wall mounted enclosures RAL 7035 with soft membrane cover - self-supporting for duct

		Cod. Code	Descrizione Description	Info	€	□	□
		45ST01	Contenitore da parete 1 modulo <i>1 module wall mounted enclosure</i>			1	24
		45ST02	Contenitore da parete 2 moduli <i>2 modules wall mounted enclosure</i>			1	24
		45ST03	Contenitore da parete 3 moduli <i>3 modules wall mounted enclosure</i>			1	20
		45ST04	Contenitore da parete 4 moduli <i>4 modules wall mounted enclosure</i>			20	20





Nota: grado di protezione garantito IP55 con apparecchi di comando o altri apparecchi modulari che consentano la chiusura dello sportello nella condizione ordinaria di servizio
Note: IP55 protection degree guaranteed with control devices or other modular devices that allow the closure of the lid in ordinary performing conditions

361



Sistema 45

Soluzioni IP55/IP66 multiple da parete per tubo Wall mounted double enclosures IP55/IP66 solutions for duct

		Cod. Code	Descrizione Description	Info	€	□	□
		BP155-66	Box da parete per 3 moduli IP55 + 2 moduli AVE SEAL - da completare con n° 1 45SP43K + n° 1 44SP42K - grado di protezione garantito IP55 con apparecchi di comando (*) da un lato e prese dall'altro <i>Wall mounted box for IP55 3 modules + AVE SEAL 2 modules to be completed with n°1 45SP43K + n° 1 44SP42K - IP55 protection degree guaranteed with control devices (*) on the one hand and sockets on the other hand</i>			1	1
		45SP43K	Coperchio 3 moduli con sportello con membrana cedibile <i>3 modules cover with soft membrane lid</i>			1	8
		BG155	Box testa-palo a 1 fronte IP55 - installabile su palo BG100 - da completare con n° 1 45SP43K - grado di protezione garantito IP55 con apparecchi di comando (*) <i>Box on pole top with 1 IP55 front - to be installed on pole BG100 to be completed with n. 1 45SP43K - IP55 protection degree guaranteed with control devices (*)</i>			1	1
		BG155-66	Box testa-palo a 2 fronti IP66 + IP55 - installabile su palo BG100 - da completare con n° 1 44SP42K + n° 1 45SP43K - grado di protezione garantito IP55 con apparecchi di comando (*) da un lato e prese dall'altro <i>Box on pole top with 2 IP66 + IP55 fronts - to be installed on pole BG100 to be completed with n. 1 44SP42K - IP55 protection degree guaranteed with control devices (*) on the one hand and sockets on the other hand</i>			1	1
		BG100	Palo isolante per box testa palo - Ø esterno 60mm - lunghezza 1 <i>Insulating pole for garden enclosures - external Ø 60mm - length 1m</i>			1	1

Le dimensioni, salvo diversamente specificato, sono in mm
Dimensions, except where otherwise specified, are in mm

◇ Prodotto per scatola quadrata
Product for British Standard square box only

② Prodotto 1 modulo installabile in scatola tonda con altro prodotto 1 modulo
1 module product installable in round box with another 1 module device

□ Imballo Minimo pcs
Min. Packaging pcs

□ Imballo Standard pcs
Std. Packaging pcs